

KAYA SAFETY

KAYASAFETY.COM

2017-2018/ENG

WORKING AT HEIGHT
AND RESCUE
EQUIPMENT

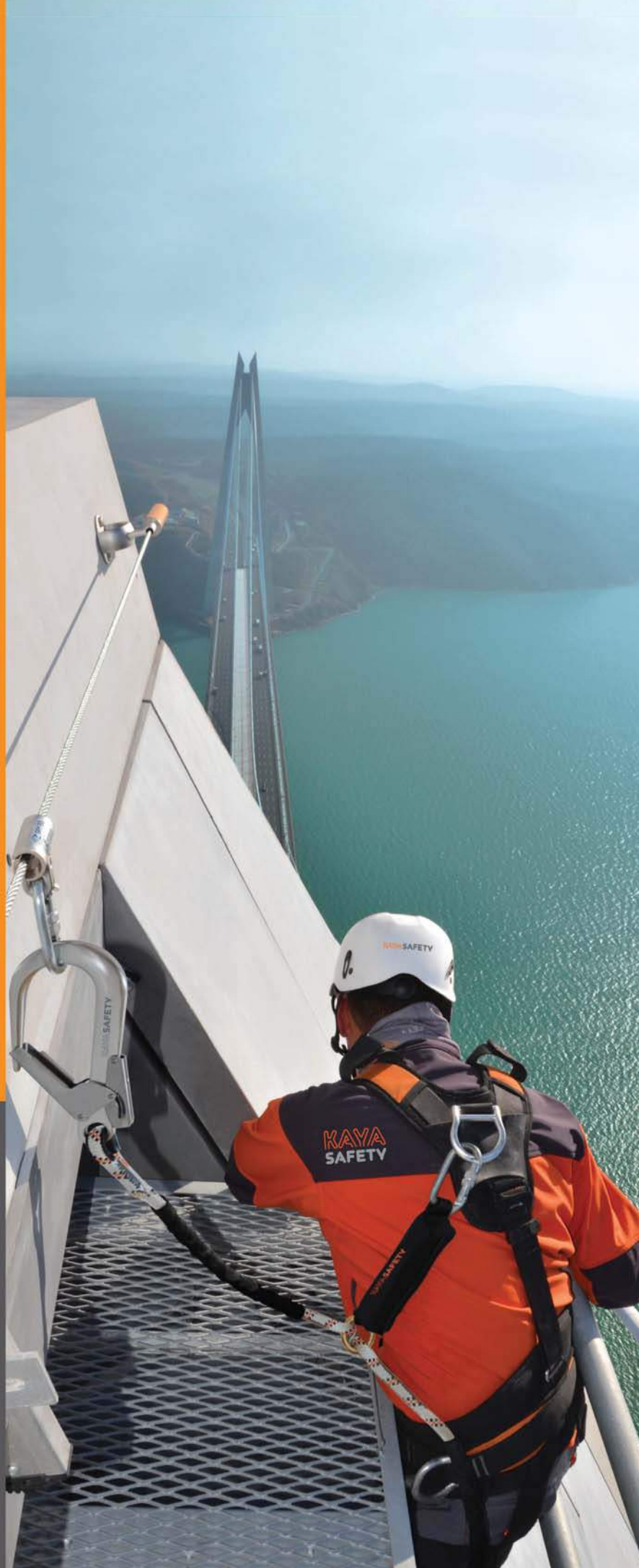



İŞ'TE YÜKSEK GÜVENLİK

HIGH SAFETY AT WORK

KAYASAFETY.COM

MEET MUSA

It is an ordinary day for Musa at 26 meters above the ground. He is a fully certified Occupational Safety Training team leader. He has been a part of the Kaya Safety team for eight years and has trained over 5000 people during this time.

Every day Musa spends a good deal of his time at heights that would make most people dizzy. And he does not do this alone... Like all of us, he carries his loved ones on his mind, in his heart, and often on his shoulders. His 4 year old son, Kuzey, and his wife, Duygu, are the main reason why he needs to go home every day, without a scratch.

Musa has a passion for heights and is an experienced mountaineer. The 7010 meter high summit of Mount Khan Tengri in Kyrgyzstan is one of his favorite conquests. He wishes that Kuzey shares his passion when he grows up. Musa has already planned their first expedition as father and son: Mount Kaçkar in northern Turkey. This is why we make sure that Musa goes home every day, without a scratch...







KAYASAFETY

Kaya safety was established in 1996 to design systems and equipment for work at height activities to be performed properly and safely.

Having the most advanced facility in its field, Kaya Safety designs, develops and manufactures fall arrest systems, rescue and evacuation equipment and lifting equipment in Turkey for institutions and organizations operating in sectors such as Defense, Firefighting, Oil & Gas, Construction and Telecommunication.

In addition to our knowledge and experience gained from working in different fields for over 18 years, we are aware of the issue that employees and managers need to take the necessary training for correct use of safety equipment and systems. We provide sector based trainings in our training facility which is one of the largest working at height simulation centers in Europe. We also support our users with technical documents and product videos for equipment to be used correctly and efficiently.



KAYAROPES

Kaya Ropes manufactures all kinds of ropes for every field, where life safety and performance is aimed, that are made of from various types of raw materials, at different construction with internationally recognized certifications.

Kaya Ropes has become a leader of innovation in Turkey and one of well-known and requested brands in the world with its technical and technological ropes.

Equipped with most developed machineries, Kaya Ropes manufactures ropes for Sailing, Yachting, Military, Off-Road, Playground, Mountaineering, Rescue, Civil Defense, Safety, Fishing, Energy, Mining and so on.



KAYA TRAINING

KAYA CONSULTING

Combining with 30 years of knowledge of Kaya Group in Occupational Health and Safety; Kaya Training and Kaya Consulting provide solutions in Strategic Management Consulting, Occupational Health & Safety and Joint Health Security Unit Services since 2001 to a large number of multinational companies and projects in almost all cities in Turkey as well as in Iraq, Gabon, Nigeria, Russia, Kazakhstan, Turkmenistan, Libya, Algeria, Albania, Kosovo, Tunisia, Saudi Arabia, Syria, Ukraine and Morocco and plays an important role in creating Occupational Health and Safety culture with its over 40 professional employees who have international experience.

Kaya Training and Kaya Consulting have 1st class training facilities and infrastructure where various industries can be simulated. The company also maintains its leadership in taking precautions in occupational health and safety and rescue activities and providing training, inspection and supervision services with aim of creating safe working environment. In addition to this, company contributes raising awareness of occupational health and safety issues in employees with its professional internal trainings.

Kaya Training and Kaya Consulting is also a partner of many well-known international organizations in Turkey such as IOSH, (Institution of Occupational Safety & Health), NSC (National Safety Council) and IRATA (Industrial Rope Access Trade Association) and part from this company is able to provide their trainings with its own trainers.

INDEX

WORKING AT HEIGHT

GENERAL PRINCIPLES OF WORKING AT HEIGHT	8-11
TELECOM SECTOR	12-15
ENERGY SECTOR	16-19
ROOFS	20-23
CONFINED SPACES	24-27
STEEL STRUCTURES	28
SCAFFOLDING	29
RESCUE	30-31
DIFFICULT TO REACH LOCATIONS (ROPE ACCESS)	32-33

PRODUCTS

HARNESSES	36-55
LANYARDS AND SHOCK ABSORBERS	56-77
CARABINERS	78-87
PULLEYS	88-97
ASCENDERS	98-103
DESCENDERS	104-113
HELMETS	114-117
MOBILE FALL ARRESTERS	118-123
RETRACTABLE FALL ARRESTERS	124-131
RESCUE DEVICES	132-137
STRETCHERS	138-143
ROPES	144-153
BAGS AND ACCESSORIES	154-157
SAFETY NETS	158-163
EDGE PROTECTION	164-167
TRIPOD AND CANTILEVER ARMS	168-187
ANCHORAGES	188-197
HORIZONTAL LIFELINE	198-211
VERTICAL LIFELINE	212-221
DEFENCE	222-239
LIFTING EQUIPMENT	240-243
ROCK PRODUCT GROUP	244-273





PRINCIPLES OF WORKING AT HEIGHT

TRAINING

Working at height is one of the biggest causes of workplace fatalities and major injuries. Employers must ensure that a sufficient risk assessment is carried out so that all risks of working at height are effectively identified, controlled and managed. Every employer must also ensure that employees are appropriately trained under careful and competent supervision to ensure that they can carry out their work safely.

Please contact **KAYA TRAINING** division of our company for more information about working at height training programs.

E-mail: egitim@kayatraining.com

GENERAL INFORMATION ABOUT FALL FROM HEIGHT

There are independent factors influencing the fall;

The weight of the user including his equipment

The greater the weight means more energy to be dissipated during the fall.

The length of the fall

The longer the fall, the more energy to be dissipated during the fall. The risk of hitting an obstacle is also greater.

The position in relation to the anchor

When the worker moves above his anchor, the severity of the potential fall increases. The fall factor concept is sometimes used to describe the position of the worker in relation to the anchor and the severity of the fall. This concept applies to climbing, restraint, or work positioning situations, when a dynamic rope lanyard is used.

PROMPT RESCUE

When a worker falls and is suspended in a personal fall-arrest system, prompt rescue must be provided because of the following reasons;

- The worker may have suffered injuries during the fall and may need medical attention.
- When workers are suspended in their safety harnesses for long periods, they may suffer from blood pooling in the lower body. This can lead to suspension trauma.
- Suspended workers may panic if they are not rescued quickly.
- The event that led to the fall may create additional risks that need to be addressed. Rescue operation must be performed by trained and competent person. Specialized equipment needed to be used to perform a safe and successful rescue.



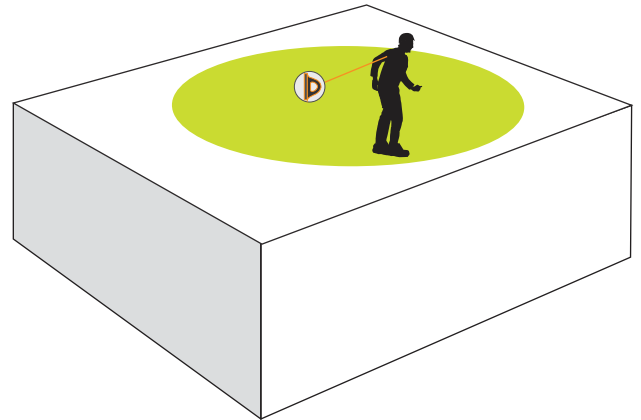

1. RESTRAINT SYSTEM

Restraint System allows workers to perform their task without the possibility of losing contact with the walking / working surface.

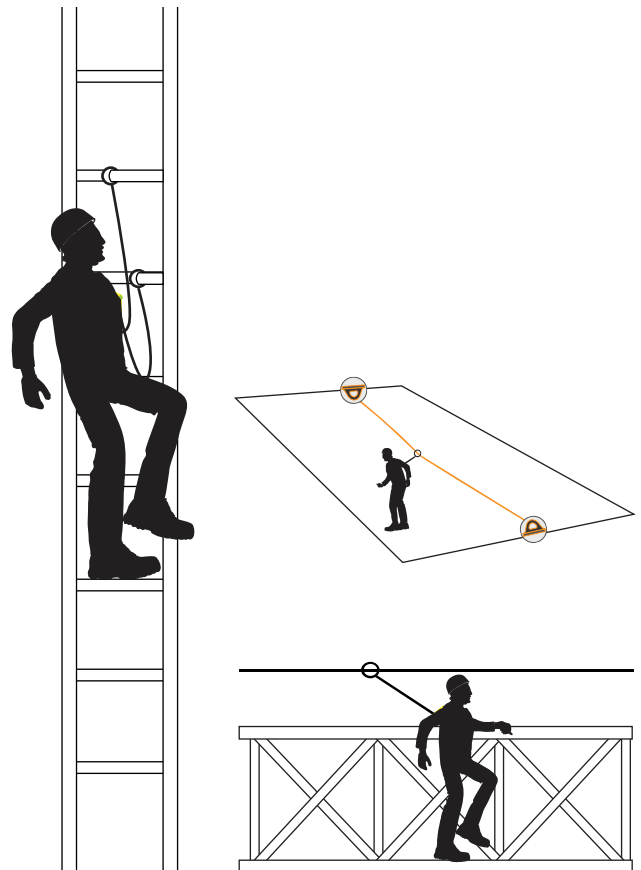

2. FALL ARREST SYSTEM

(A) Fall Arrest System is designed to stop the free fall of a user and limit the maximum arresting forces imposed on the user to 6 kN or less. A fall arrest system provides maximum freedom of movement for workers to conduct their duties by connecting to the (A) safe attachment point.

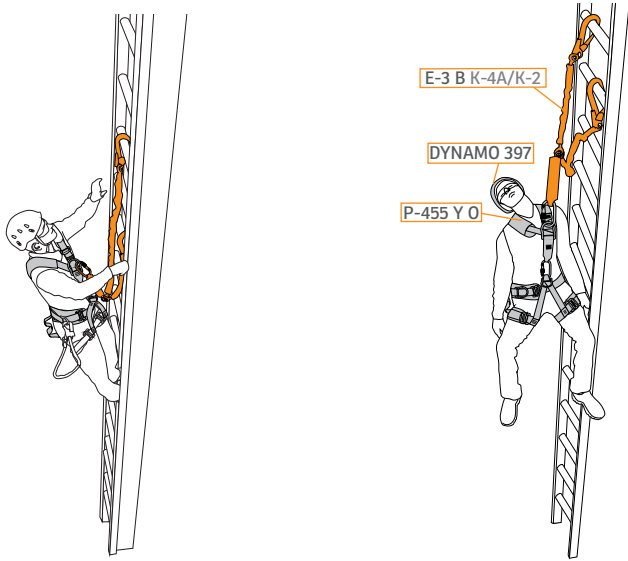

CONNECTION TO THE HARNESS VIA CHEST ANCHORAGE POINT (A) OF SAFETY HARNESS

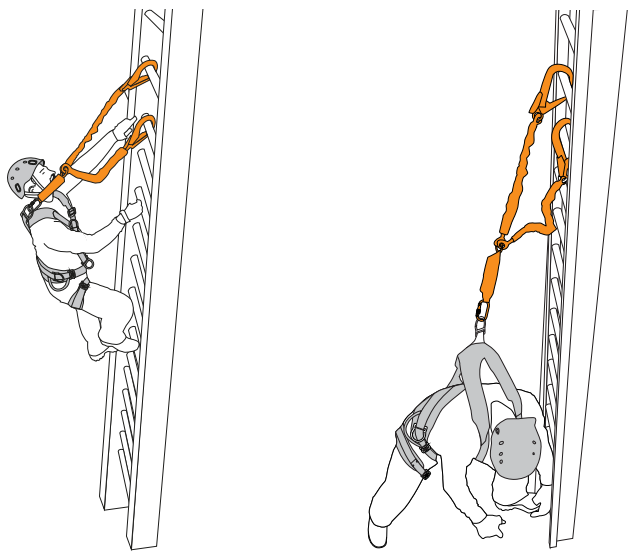

CONNECTION TO THE HARNESS VIA DORSAL ANCHORAGE POINT (A) OF SAFETY HARNESS

3. CONNECTING FALL ARREST EQUIPMENT TO FULL BODY HARNESS

Connection to the harness must only be via the appropriate connection points (dorsal attachment point or the chest connection) that will provide the best protection in the situation it is being used. Consideration should be given to the potential fall distance, potential impact with the structure and body position after a fall.

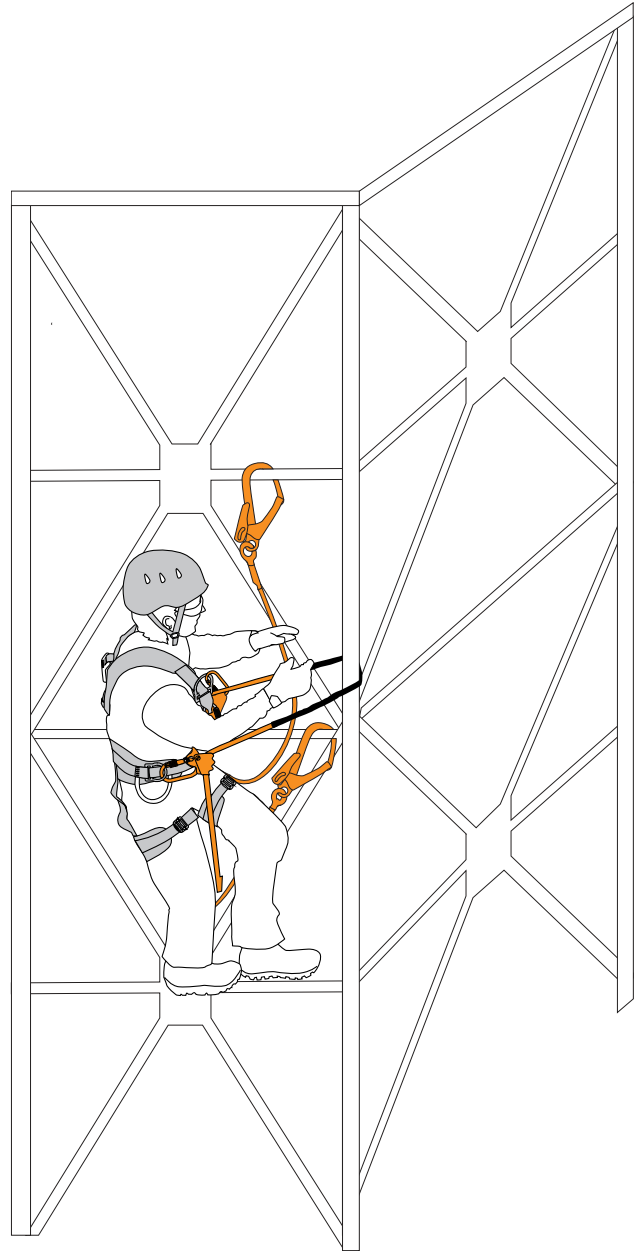

4. WORK POSITIONING

A work positioning system is used to hold a worker in place while allowing a hands-free work environment at elevated heights. A work positioning system must include a secondary system for fall arrest in the event the work positioning system should fail.

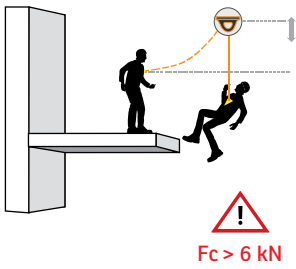

FALL FACTOR 0,5

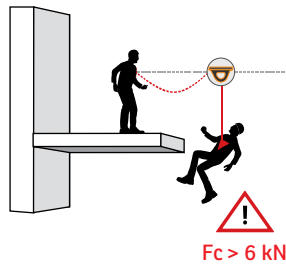

FALL FACTOR 1

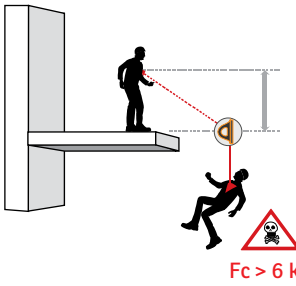
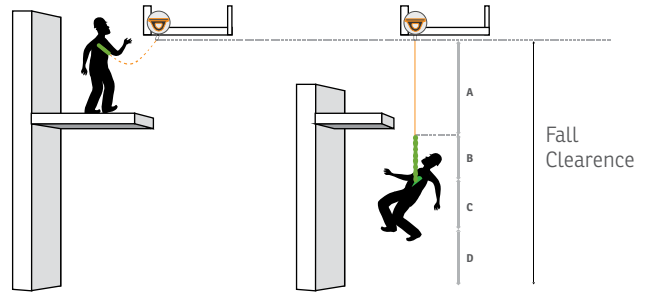

FALL FACTOR 2

USE OF LANYARD

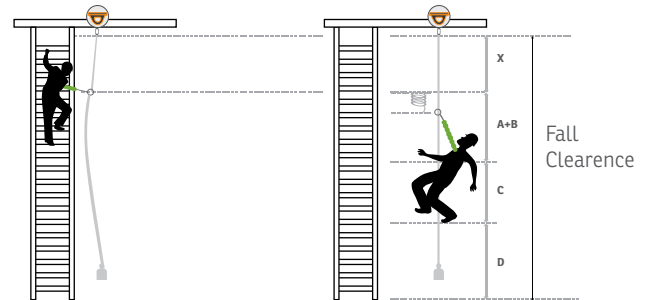

5. LIMITING THE IMPACT FORCE

- Fall arrest system must limit the maximum impact force during the arrest of a fall to 6 kN.
- Fall arrest system is generally used with a shock absorber. Energy absorber limits the fall arrest force in a fall situation by tearing specific seams.
- Fall arrest system without the use of a shock absorber is not recommended.

6. FALL CLEARANCE

Fall clearance is the height at which a worker must attach to an anchorage to avoid contact with a lower level. In order to calculate required fall clearance distance the following measurements must be kept in mind.

- A** - Length of Fall Arrest System (Lanyard).
- B** - Length of the Lanyard after a fall.
- C** - Height of Suspended Worker.
- D** - Safety Factor.
- X** - Distance of Fall Arrest System to Anchorage Point before fall.

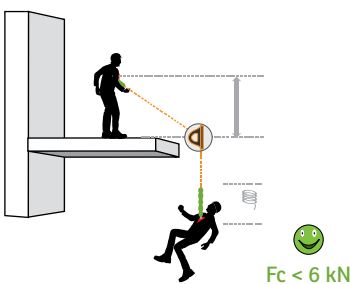

USE OF LANYARD WITH SHOCK ABSORBER

Shock absorber limits the fall arrest force by tearing specific seams even if the fall factor 2 is occurred.



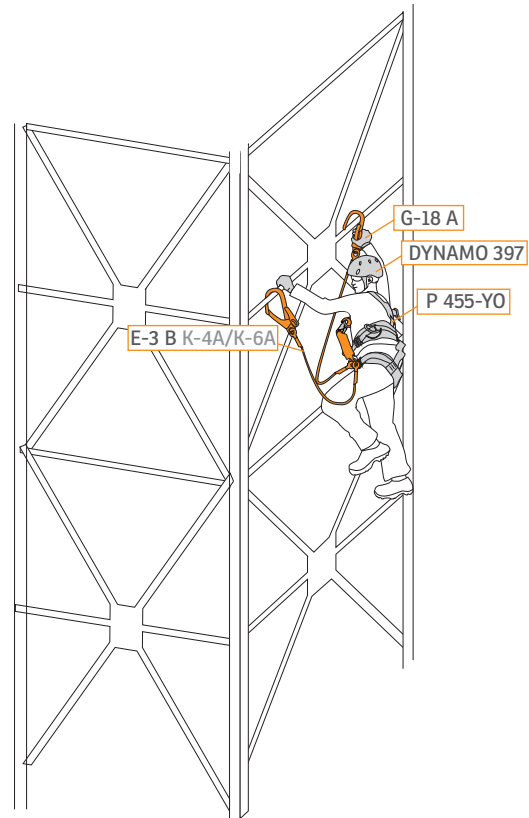
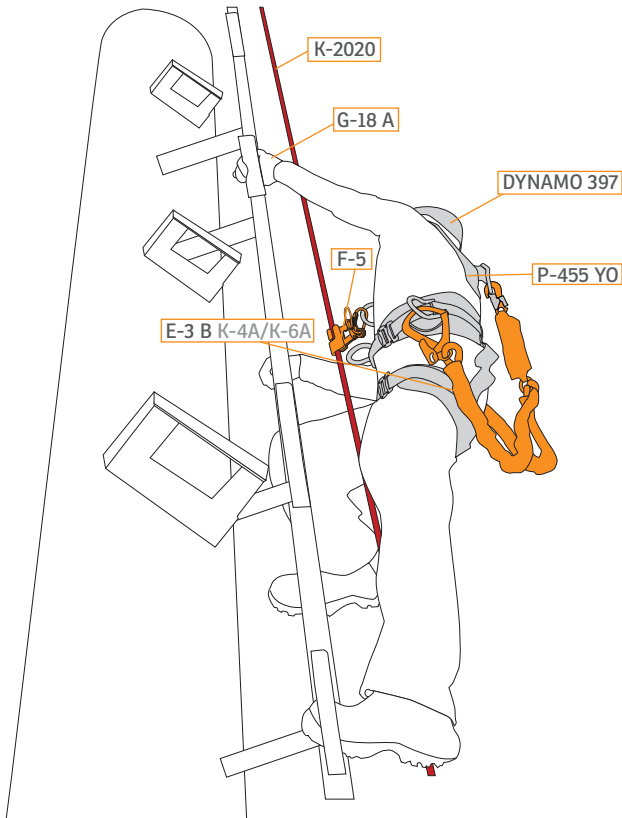

1. ASCENDING WITH VERTICAL LIFELINE

Monopole or Lattice towers are widely used in telecommunication sector. The safest way to climb up and down these towers is to use permanent vertical lifeline system installed on ladder (if such ladder exist).

User is connected to a vertical lifeline by a wire rope grab which is attached to the (A) chest attachment point of full body harness. When the user moves (up or down), it slides along the life line. In the event of a fall, the device stops the fall instantly on the cable.

2. ASCENDING WITH DOUBLE LEGGED SHOCK ABSORBING LANYARD

If there is no vertical lifeline fixed on tower then user uses the double-legged shock absorbing lanyard to move around the tower whilst being connected at all times. It is recommended to attach double-legged shock absorbing lanyard to the (A) chest attachment point of full body harness.



K-2020



F-5



DYNAMO 397



P-455 YO



E-3 B K-4A/K-6A



G-18 A

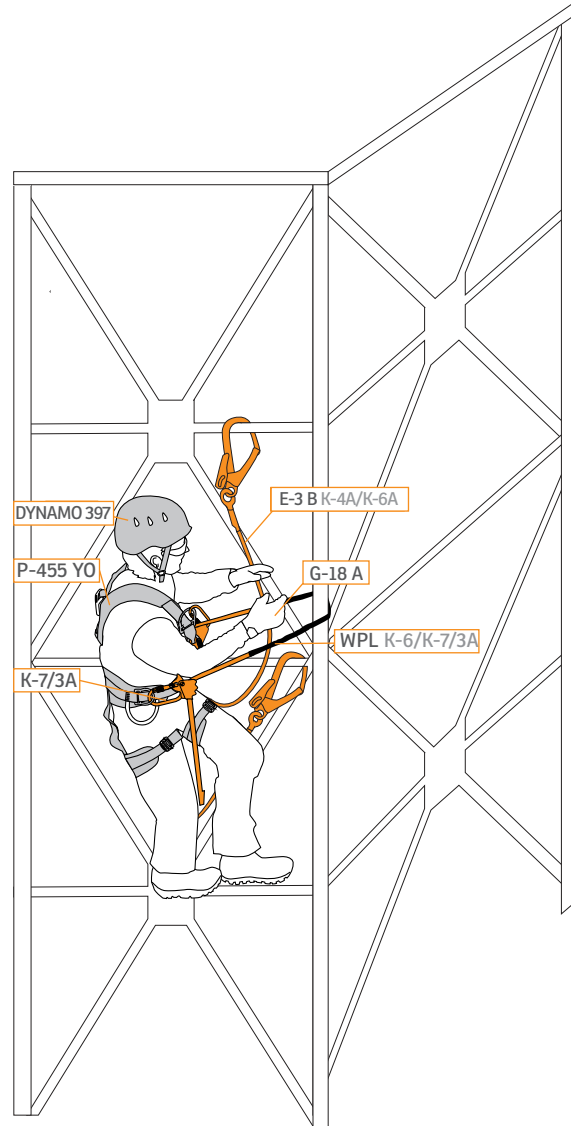
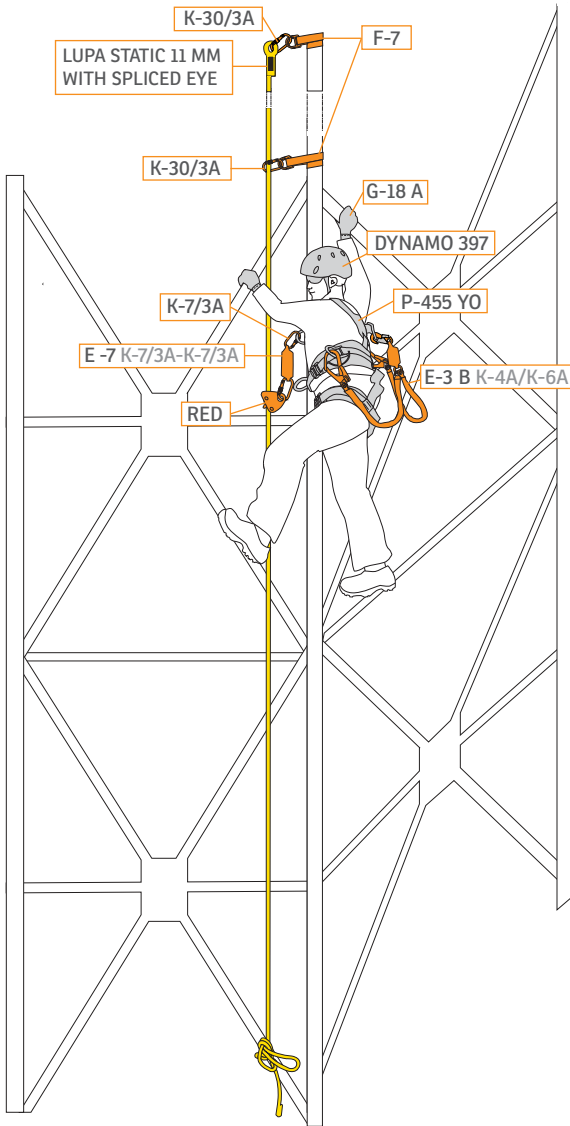

3. CREATING VERTICAL LIFELINE

If there is no vertical lifeline fixed on tower, the first user who climbs up tower with a double-legged shock absorbing lanyard creates mobile vertical lifeline on tower using rope. The other users climb up the tower using this mobile vertical lifeline by help of appropriate rope grab.

4. WORK POSITIONING WITH ADJUSTABLE LANYARD

Adjustable lanyards are designed to be used as part of a work positioning system and enable users to work at height hands-free position. The lanyard is fitted around a supporting structure and then connected to the side D-rings on the operator's harness.







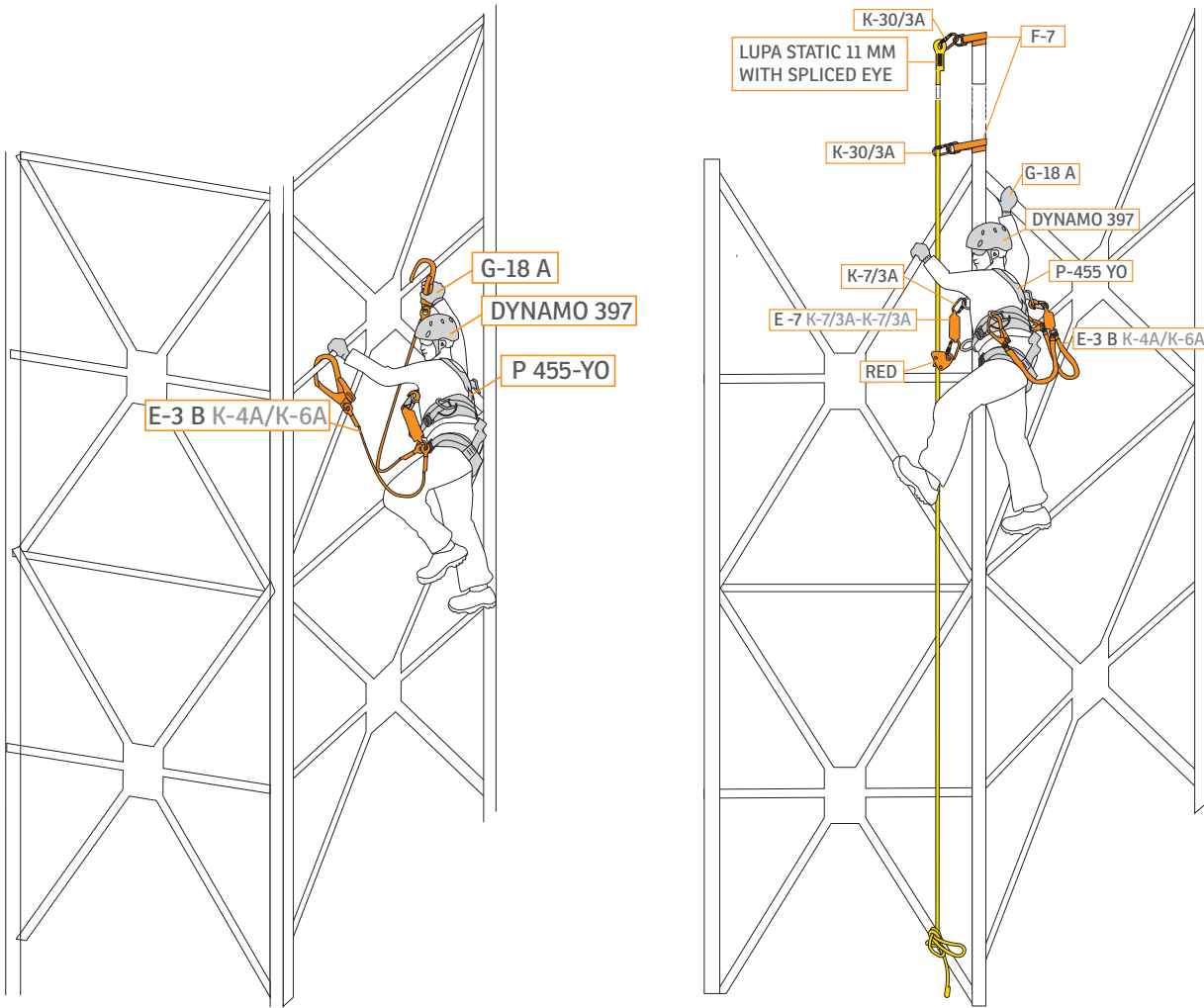

1. ASCENDING WITH DOUBLE-LEGGED SHOCK ABSORBING LANYARD

If there is no vertical lifeline fixed on energy towers then user uses the double-legged shock absorbing lanyard to move around the tower whilst being connected at all times. It is recommended to attach double-legged shock absorbing lanyard to the (A) chest attachment point of full body harness. Connection from chest anchorage point prevents a falling worker hitting from surface facing toward user.

2. CREATING VERTICAL LIFELINE WITH ROPE

If there is no vertical lifeline fixed on energy towers, the first user who climbs up tower with a double-legged shock absorbing lanyard creates mobile vertical lifeline on tower using rope. The other users climb up the tower using this mobile vertical lifeline by help of appropriate rope grab.



F-7 K-30/3A LUPA® STATIC 11 MM WITH SPLICED EYE K-7/3A E-7 RED DYNAMO VOLT P-455 YO E-3 B K-4A/K-6A WPL K-6/K-7 3A G-18 A

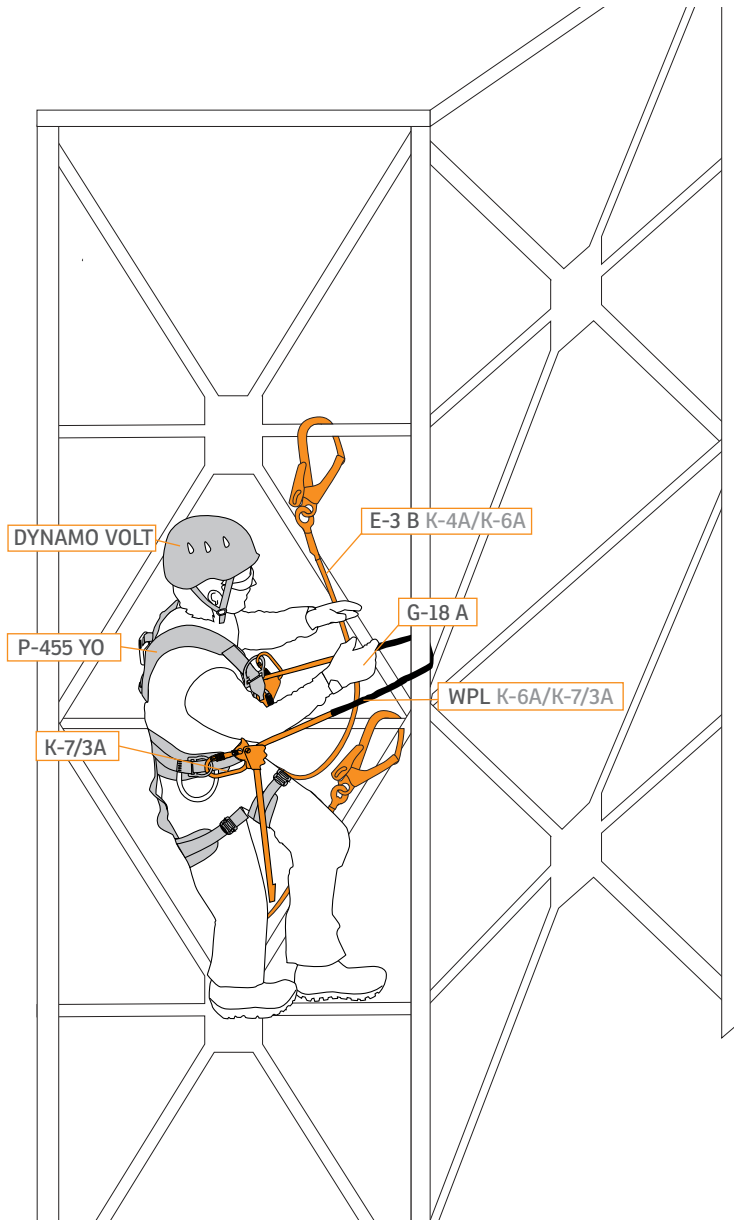

3. WORK POSITIONING WITH ADJUSTABLE LANYARD

Double-legged shock absorbing lanyard protects the user in a potential fall situation and arrest the fall when working on energy towers. Adjustable lanyards are designed to be used as part of a work positioning system and allow users to work at these towers hands-free position. The lanyard is fitted around a supporting structure and then connected to the side D-rings on the operator's harness.



DYNAMO VOLT



P-455 YO



E-3 B K-4A/K-6A



G-18 A



WPL K-6A/K-7 3A



K-7/3A

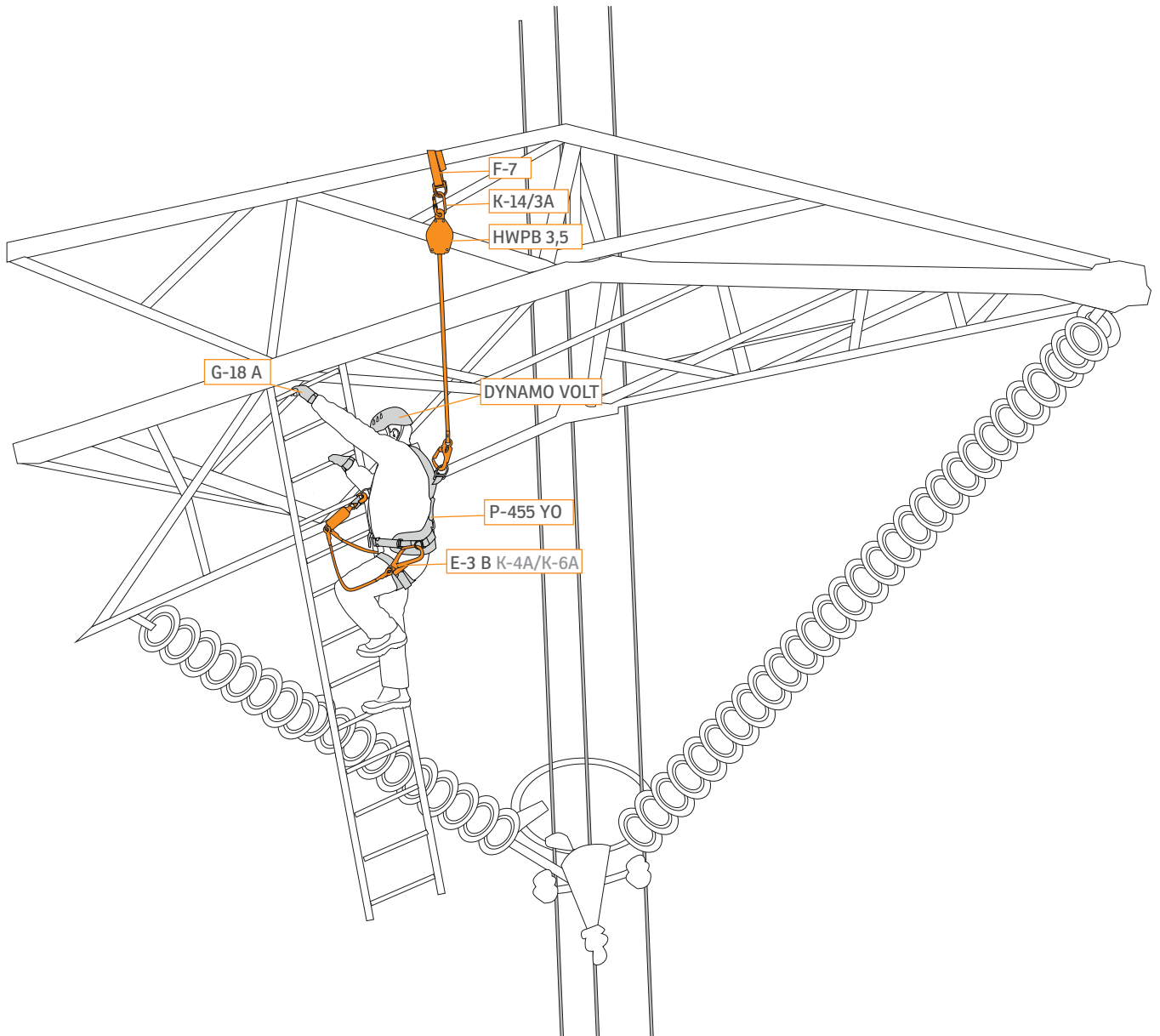

4. WORKING WITH RETRACTABLE FALL ARRESTER

Use ladder to reach electrical insulators when working on electricity power lines. Retractable Fall Arrester Device should be used when moving up and down on ladders.



DYNAMO VOLT



P-455 Y0



E-3 B K-4A/K-6A



F-7



K-14/3A



HWPB 3,5



G-18 A



WORKING ON THE ROOF WITH FIXED HORIZONTAL LIFELINE

All work on roofs is highly dangerous because it involves work at height. Fall from a roof inevitably involves at least a serious injury. Falls occur;

- from the edges of roofs
- through gaps or holes in roofs; and
- through fragile roof materials and roof lights

Horizontal Lifeline System provides fall protection and safe access on all areas of the roof for workers. System offers workers continuous hands free movement and navigates corners and building contours, thereby providing maximum design and integration flexibility.

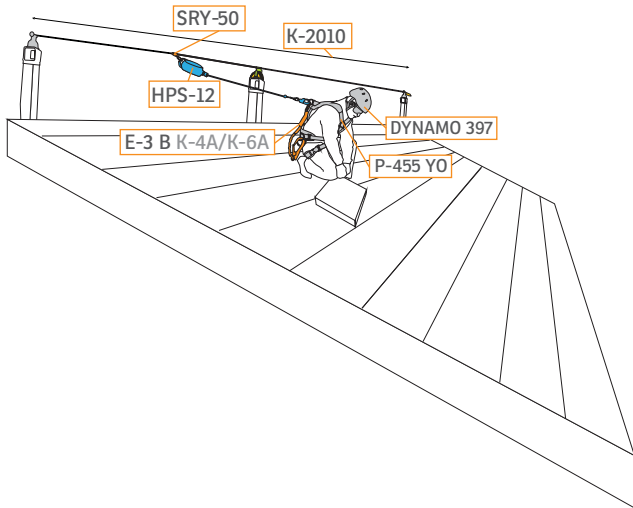

1.1. RETRACTABLE FALL ARRESTERS LIMITS FREE-FALL DISTANCE, DECELERATION DISTANCE AND FALL ARREST FORCES WHILE ALLOWING USER FREEDOM OF MOVEMENT.

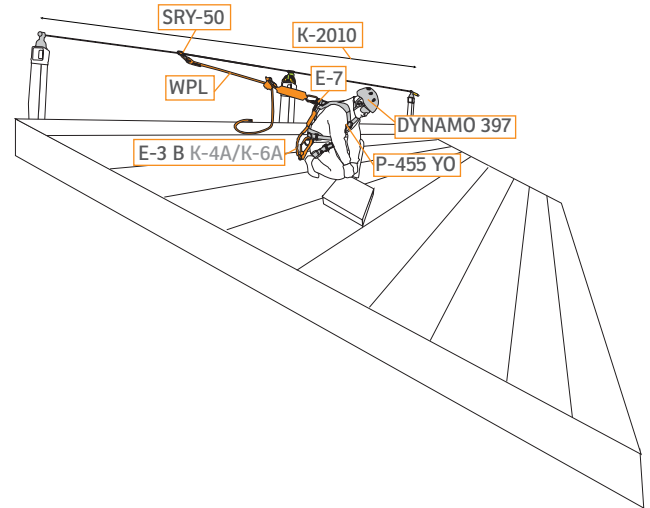

1.2. WPL - WORK POSITIONING LANYARDS ARE IDEAL FOR FALL ARREST AND RESTRAINT WHILE WORKING ON THE ROOF USING THE LIFELINE.

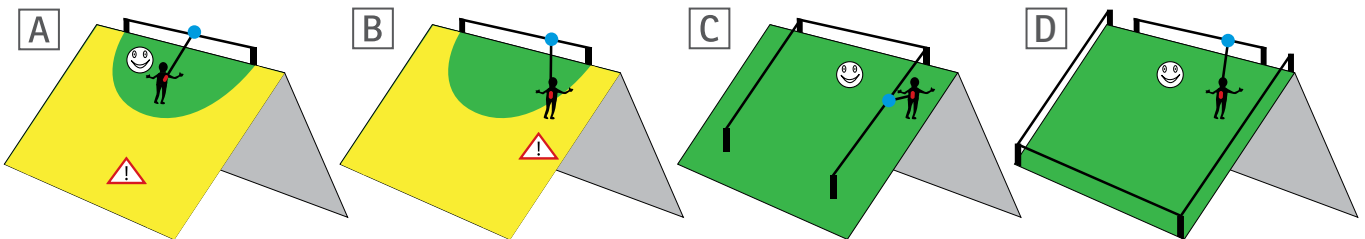

When working on the roofs with fixed horizontal lifelines, it is safe to work on the roof edges at distant points (**Figure-A**). When working near the edges of the roof, it must be taken a serious care against pendulum effect which will occur after a fall (**Figure-B**). If work is going to be performed on the sides of the roof, then lifeline shall be installed on the edges and the fall arrest equipment should be used in this section (**Figure-C**) or having safety rail on the edges would also prevent the fall (**Figure-D**).



K-2010 DYNAMO 397 P-455 YO E-3BK-4A/K-6A WPL K-6A/K-73A E-7 K-7/3A K-14/3A HPS-12 G-18 A

2. WORKING ON THE ROOF WITH MOBILE HORIZONTAL LIFELINE

If there is no permanent lifeline system on the roof then mobile lifeline system may be installed for safe work to be performed. This system must be installed by competent person who has the necessary technical skills and training.

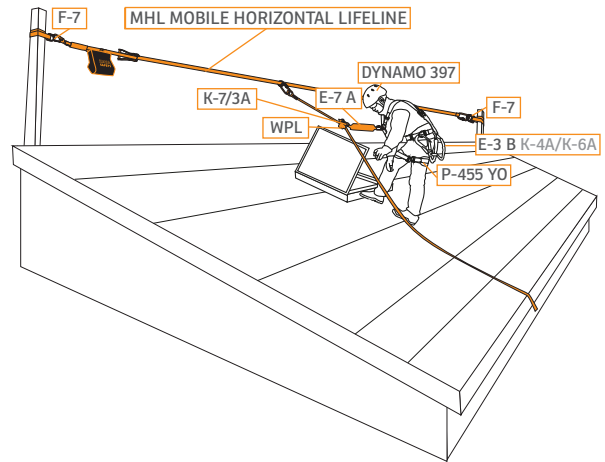
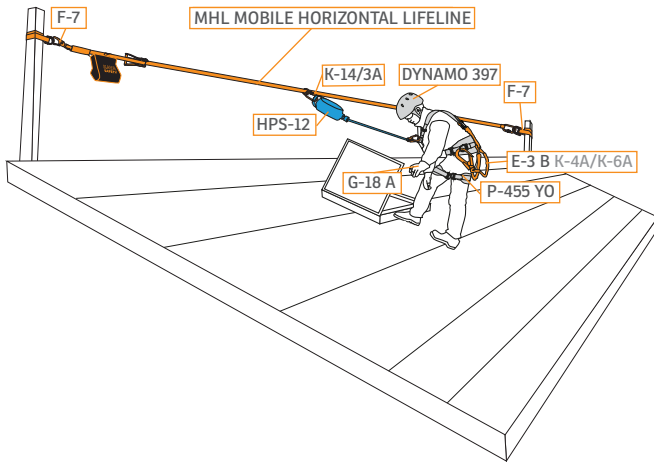

2.1. WORKING ON MOBILE HORIZONTAL LIFELINE WITH WPL WORK RESTRAINING LANYARD

User may connect himself to the Mobile Horizontal Lifeline via WPL Work Restraining Lanyard to perform his work safely.

2.2. WORKING ON MOBILE HORIZONTAL LIFELINE WITH RETRACTABLE FALL ARRESTER DEVICE

User may connect himself to the Mobile Horizontal Lifeline via Retractable Fall Arrester Device to perform his work safely.

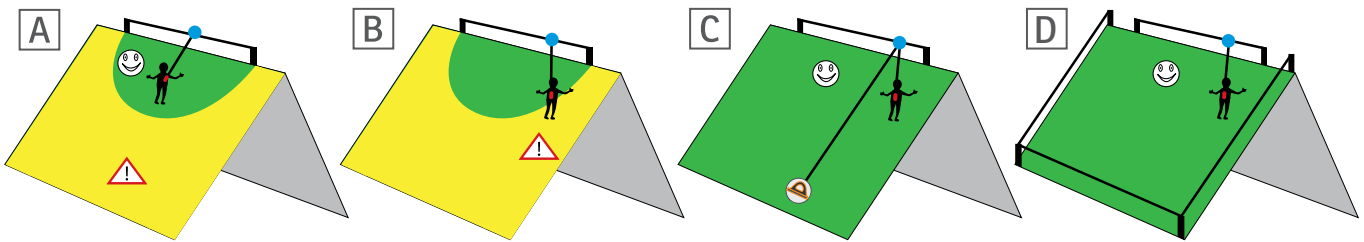

When working on the roofs with mobile horizontal lifelines, it is safe to work on the roof edges at distant points (Figure-A). When working near the edges of the roof, it must be taken a serious care against pendulum effect which will occur after a fall (Figure-B). If work is going to be performed on the sides of the roof, then work restraining lanyard should be used in this section (Figure-C) or having safety rail on the edges would also prevent the fall (Figure-D).





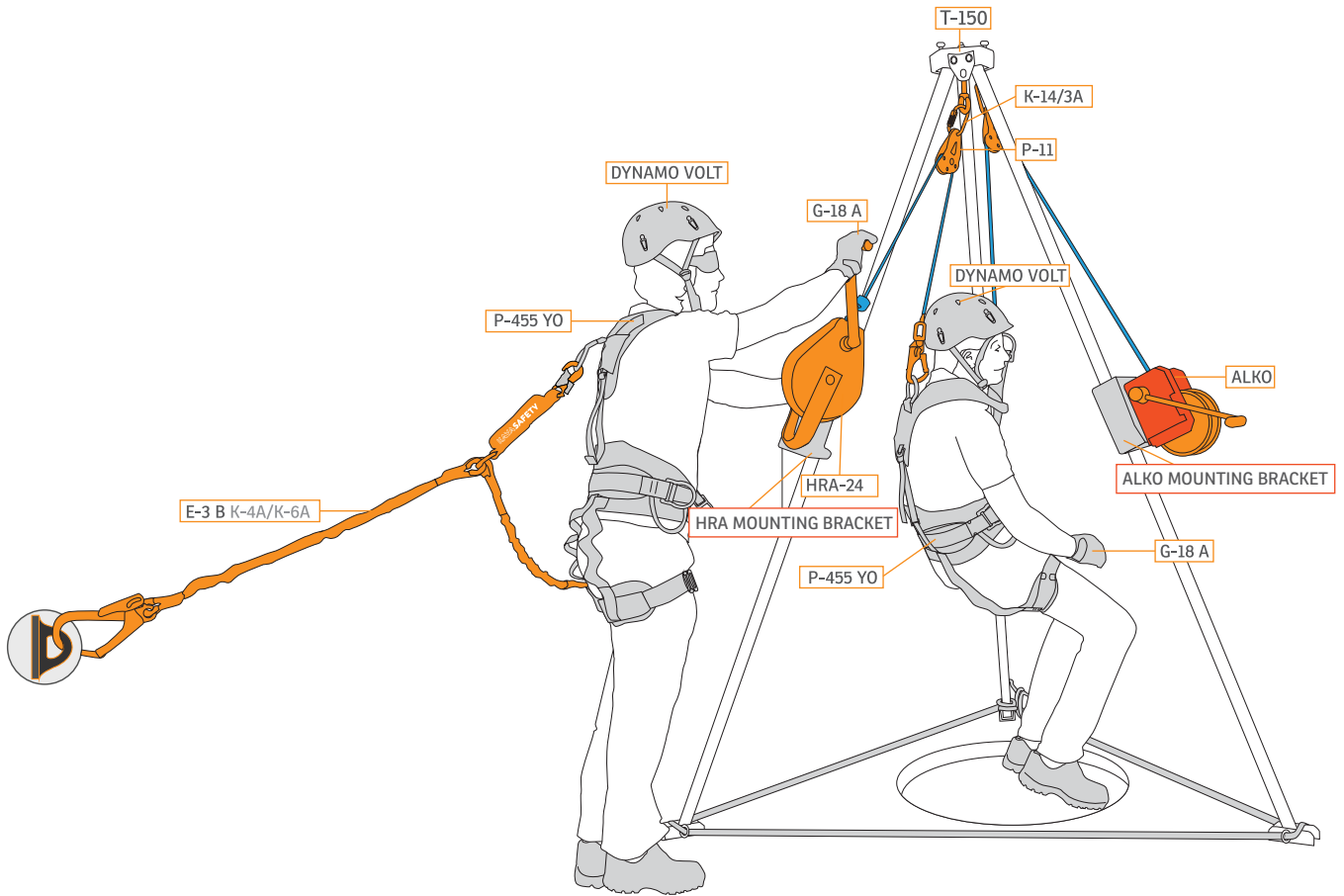

1.CONFINED SPACES

Many workplaces contain areas that are considered "confined spaces" because while they are not necessarily designed for people, they are large enough for workers to enter and perform certain jobs. A confined space also has limited or restricted means for entry or exit and is not designed for continuous occupancy.



DYNAMO 397 P-455 YO E-3 B K-4A/K-6A G-18 A T-150 K-14/3A P-11 HRA MOUNTING BRACKET HRA-24 ALKO MOUNTING BRACKET ALKO WINCH

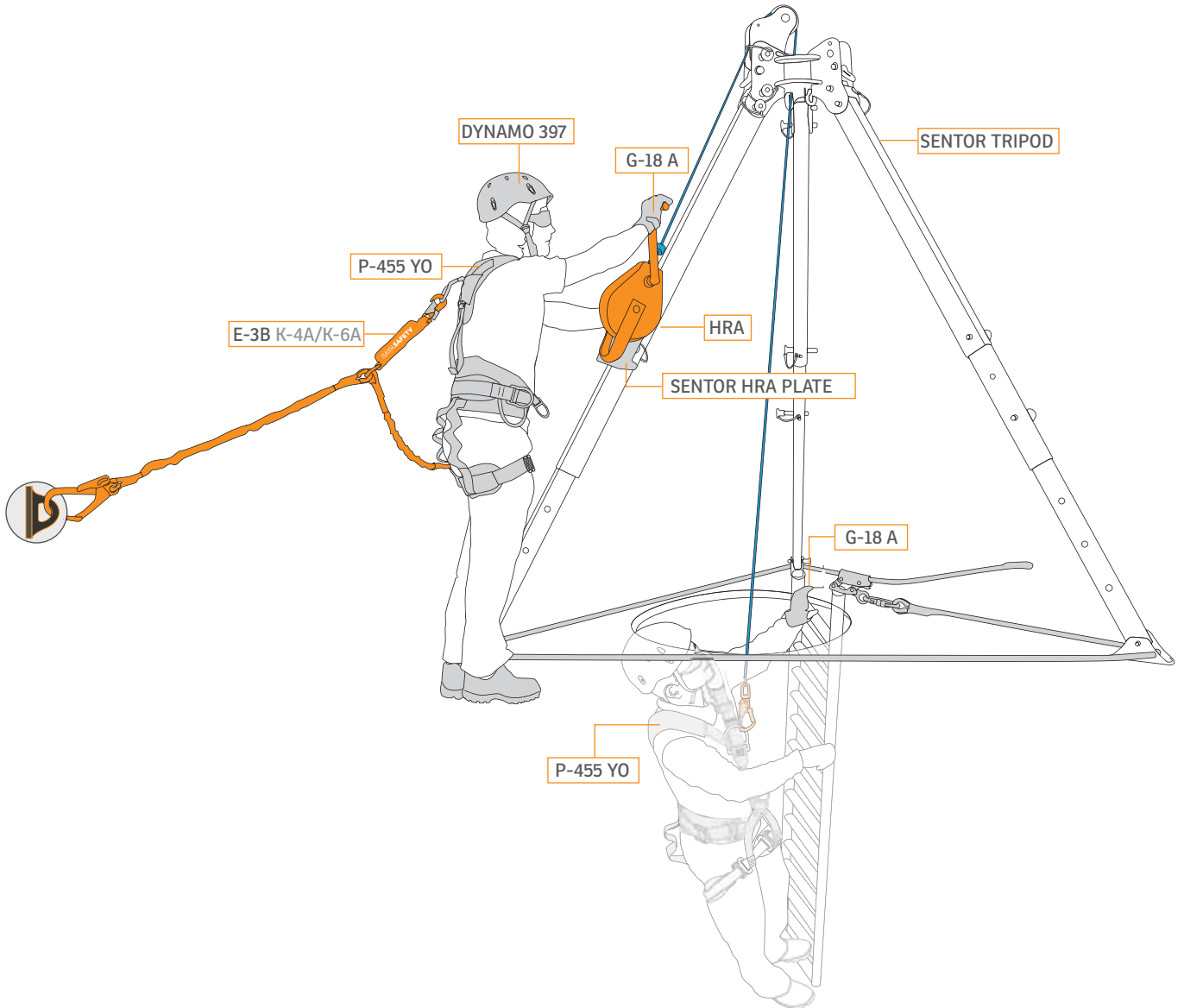

2. WORKING IN CONFINED SPACE WITH TRIPOD AND HRA RETRACTABLE FALL ARRESTER BLOCK WITH RECOVERY MECHANISM

If there is a ladder in confined space the best way to work in there is to use a tripod with a Retractable Fall Arrester Block with Recovery Mechanism.



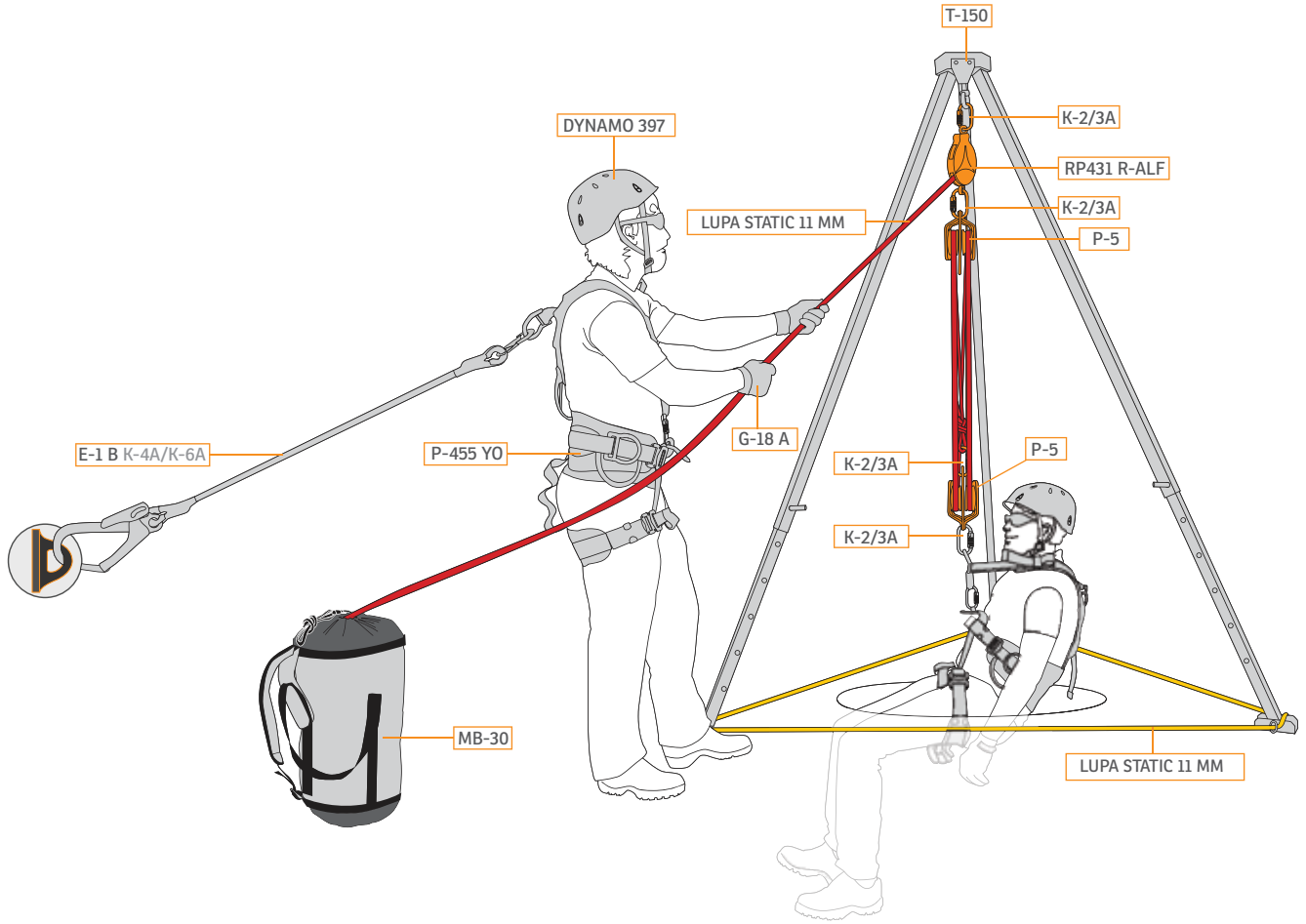

3. WORKING IN CONFINED SPACE WITH TRIPOD AND RESCUE PULLEY

R-ALF rescue pulley is used as part of work suspension system either in confined spaces as a user can easily lift/lower themselves. If the user loses control of the decent the over speed brake will automatically kick in. 11 mm static rope is recommended and the length static rope varies depending on the depth of confined space.

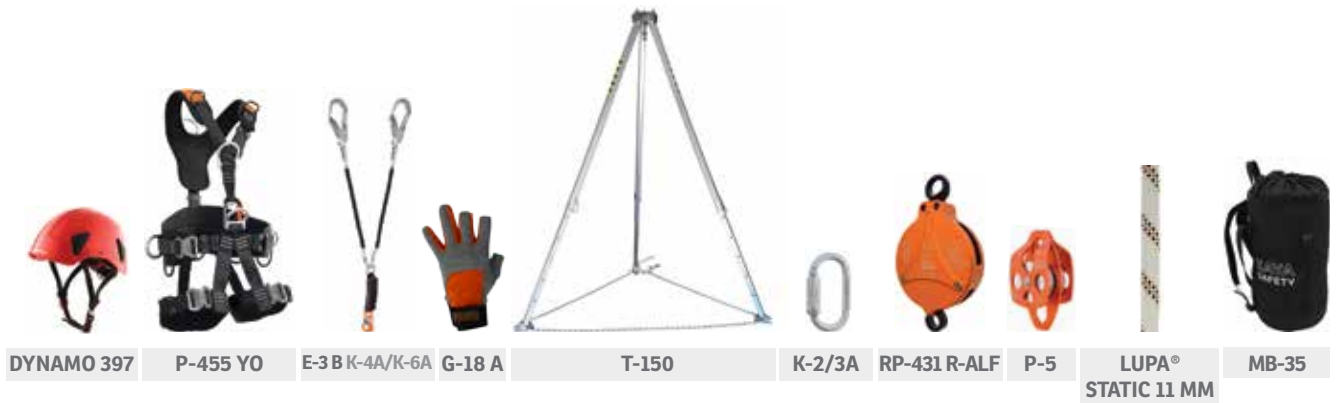

DYNAMO 397	P-455 YO	E-3 B K-4A/K-6A	G-18 A	T-150	K-2/3A	RP-431 R-ALF	P-5	LUPA® STATIC 11 MM	MB-35
------------	----------	-----------------	--------	-------	--------	--------------	-----	-----------------------	-------



TECHNO ARM



TECHNO ARM MOBILE LEG SET



AASS-1



AASS-2



AASS-3



AASS-4



AASS-M



AASS-MV

4. WORKING IN CONFINED SPACE WITH CANTILEVER ARM AND HRA RESCUE DEVICE

Portable and permanent cantilever arms are essential part of a confined space access or rescue plan and provide a fixed anchorage point for work winches or rescue systems for entering confined spaces. Portable design allows for easy transport and storage. Adjustable legs enable them to fit most confined space entry.

Cantilever Arms comes with HRA Fall Arrester Block with Recovery Mechanism or / and ALKO rescue winch to lower or raise victim to safe location.



GROUND SLEEVE



WALL SLEEVE



LOWER GROUND SLEEVE



LOWER GROUND SLEEVE CORE HOLE

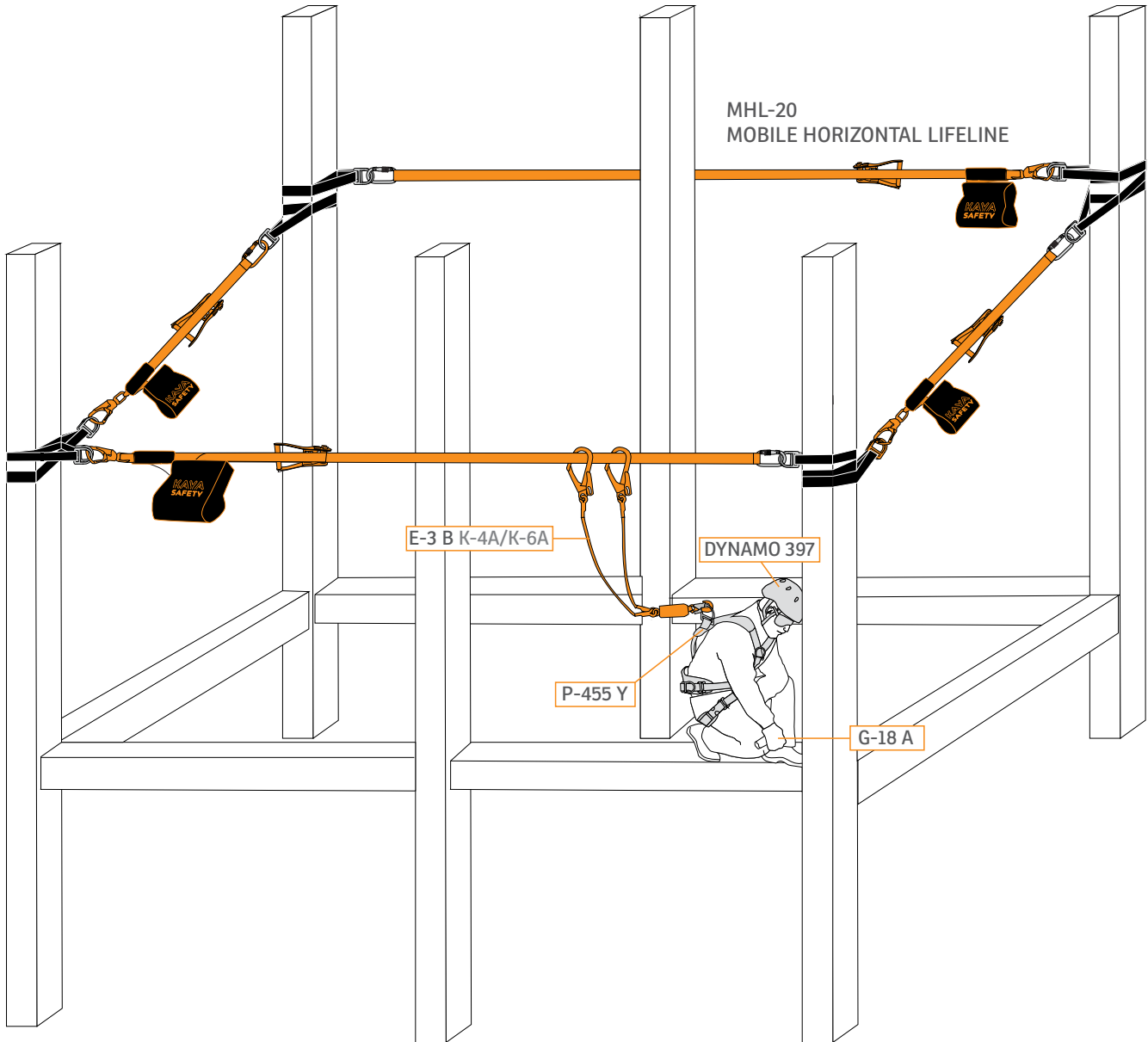

WORKING IN STEEL STRUCTURES

MHL-20 Mobile Horizontal Lifeline is installed in steel structures for safe work to be performed.

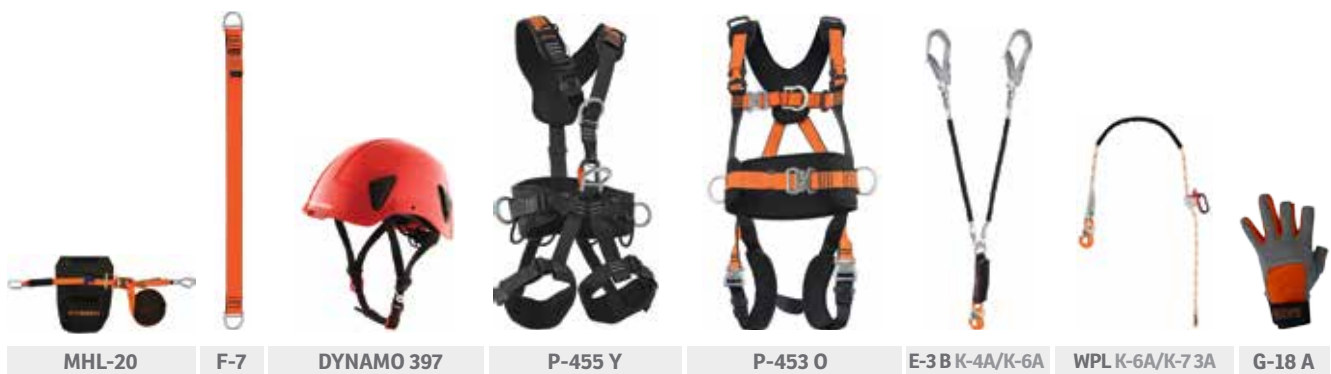

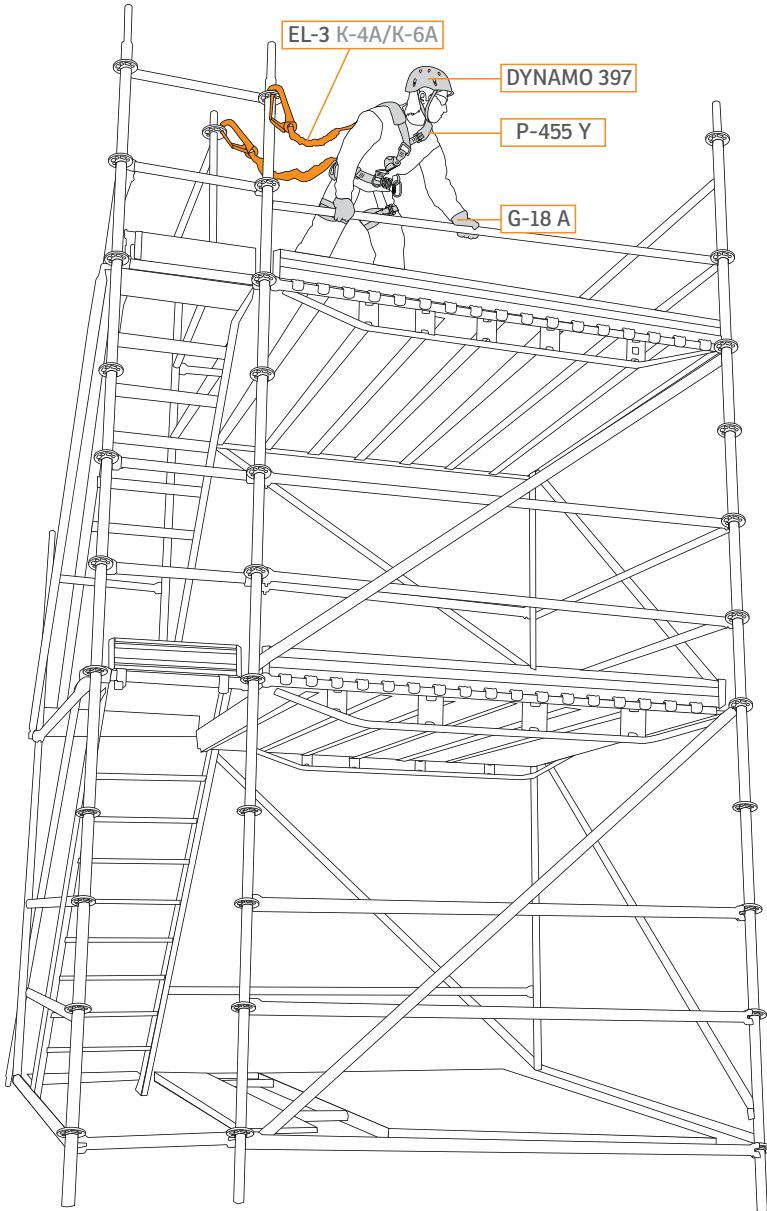

SCAFFOLDING INSTALLATION

When working on scaffolding user must have a fall protection system attached to either a secure attachment point on scaffolding or to a structure.



DYNAMO 397



P-455 Y

or



P-453 O

or



E-3 B K-4A/K-6A



EL-3 K-4A/K-6A



G-18 A



If a person has fallen and is suspended in an inaccessible area then follow below steps for immediate rescue;

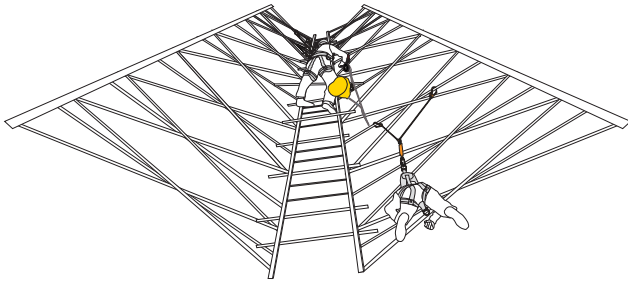

STEP 1: REACHING TO SUSPENDED WORKER

Rescuer is to set up a manual descent control system at a secure anchorage point located above suspended worker with ABS 3WH rescue device.

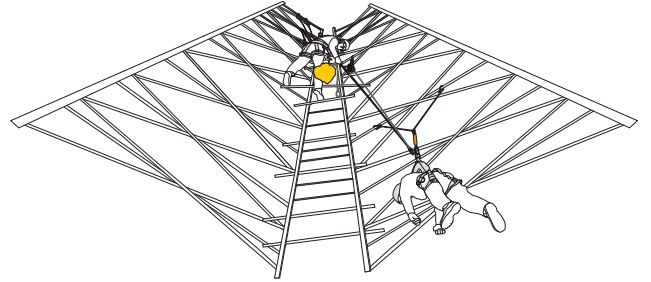

STEP 2: PREPARATION BEFORE TRANSFERRING SUSPENDED WORKER TO RESCUE SYSTEM

Rescuer connects ABS 3WH rescue device to the (A) attachment point of the full body harness of suspended worker by using the remote reach rescue pole so suspended worker can be transferred onto the rescue system.

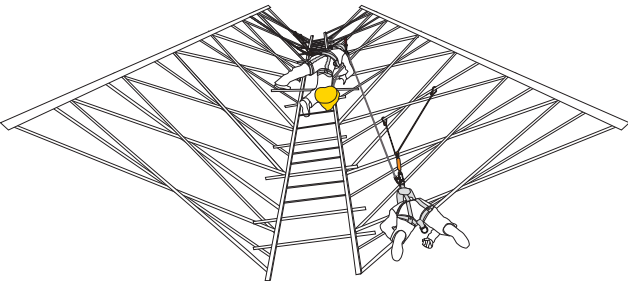

STEP 3: RE-POSITIONING

Suspended worker is lifted to higher position with rescue device to loosen the fall arrest lanyard.

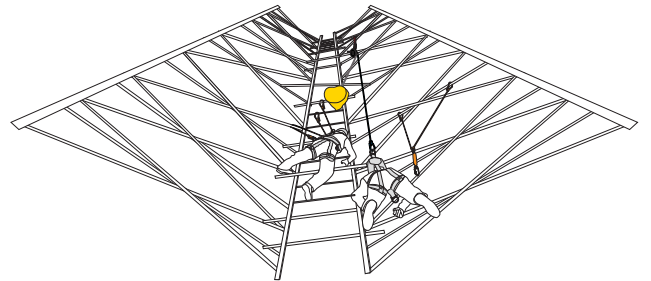

STEP 4: TRANSFERRING SUSPENDED WORKER TO RESCUE SYSTEM

Suspended worker is now transferred to descent system by releasing him/her from the lanyard.

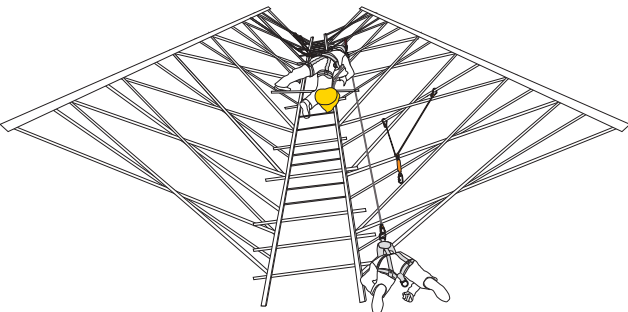

STEP 5: LOWERING SUSPENDED WORKER

The suspended worker is lowered to the ground at a constant speed of 0.9 m/sec.





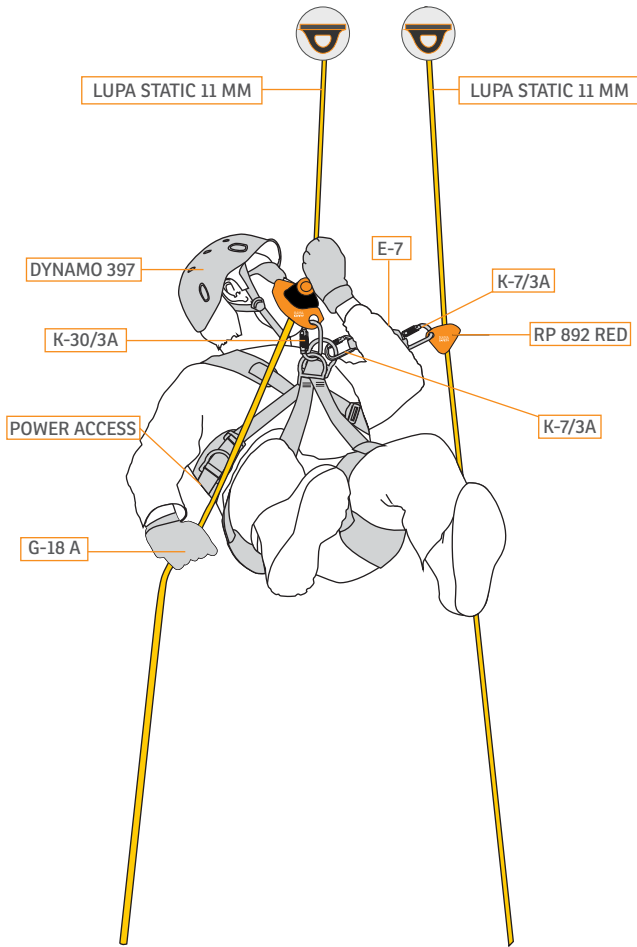

DESCENDING WITH ROPE

A descender is placed on first rope and fall arrester device with shock absorber is placed on second rope as back-up security.

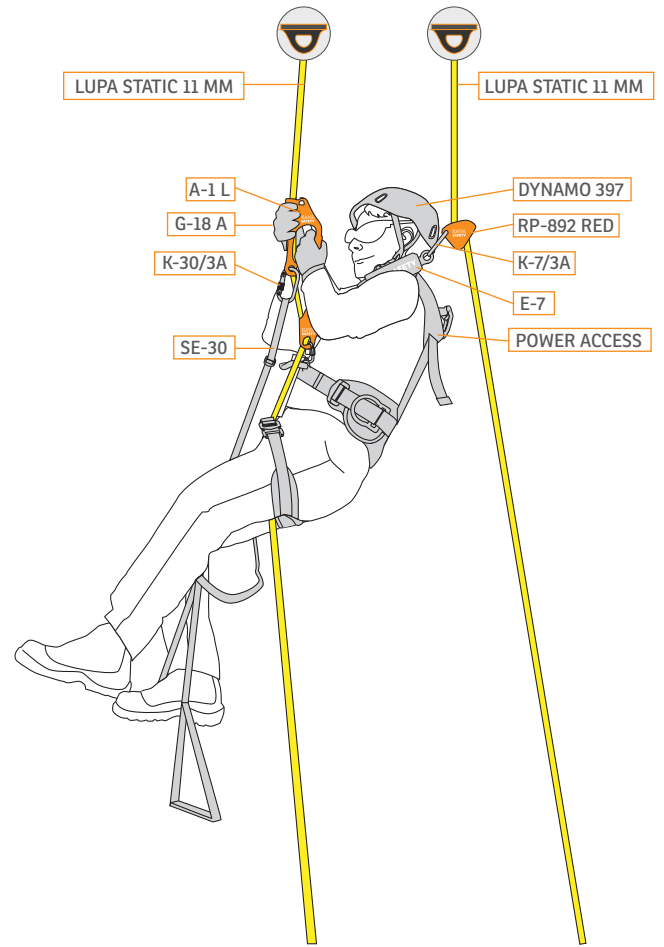

ASCENDING WITH ROPE

Ascender is used for ascending on a rope. Adjustable foot loops can also be used with handled ascenders.

DIFFICULT-TO-ACCESS AREAS

Rope access is safe method of working at height where ropes and associated equipment are used to gain access to work places without the use of scaffolding, cradles or an aerial work platform. Rope access should be regarded as a complete system, in which planning, management, competence and suitable equipment should be treated with equal importance as each is dependent on the others to ensure a safe system of work.

Rope access methods must be carried out by trained and competent person.

Rope access system is usually achieved by using two ropes; one as a means of access and the other as back-up security, used with a harness in combination with other devices for getting to and from the place of work and for work positioning.





HARNESSES 36-55



LANYARDS AND SHOCK ABSORBERS 56-77



CARABINERS 78-87



PULLEYS 88-97



ASCENDERS 98-103



DESCENDERS 104-113



HELMETS 114-117



MOBILE FALL ARRESTERS 118-123



RETRACTABLE FALL ARRESTERS 124-131



RESCUE EQUIPMENT 132-137



STRETCHERS 138-143



ROPES 144-153



BAGS AND ACCESSORIES 154-157



SAFETY NETS ————— 158-163



EDGE PROTECTION ————— 164-167



TRIPOD AND CANTILEVER ARMS ————— 168-187



ANCHORAGES ————— 188-197



HORIZONTAL LIFELINES ————— 198-211



VERTICAL LIFELINES ————— 212-221



DEFENCE ————— 222-239



LIFTING EQUIPMENT ————— 240-243



ROCK PRODUCT SERIES ————— 244-273





POWER INDUSTRY



P-455 YO



P-455 Y



P-455 YO B



P-455 Y B



P-455 Y U

FALL ARREST AND WORK POSITIONING SUSPENSION HARNESSSES

Designed to optimize body-position while hanging or during a fall. Suspension straps provide users superior comfort and flexibility.



POWER ACCESS

ROPE ACCESS SUSPENSION HARNESS

Specially designed for rope access works. Incorporated chest ascender provides an easy and secure attachment point and makes climbing up the rope smoother and more effective.



P-453 O

FALL ARREST AND WORK POSITIONING HARNESS

Designed for fall arrest and work positioning purposes.



P-451 PO



J-45



B-452 TO

FALL ARREST HARNESSSES

Designed for fall arrest purpose.

TELECOM HARNESS

Designed for wooden pole climbing.



FB-50



FB-50 L



BD-85 F



P-453 F

FORRESTER & FIREMAN BELTS AND HARNESSSES

Designed to be used as work restraint harness by forresters and firefighters.



I-451



I-451 A



RT-3



RT-3 A

RESCUE HARNESSSES AND TRIANGLES

Designed for rescue purpose.



M-85 AS



BM-45 A



SB-2



SB-3

MINING BELTS

Designed for miners to carry respiratory equipment and headlamp battery.



C&H-80



DH-30



DH-40

ANIMAL RESCUE HARNESSSES

Designed for rescuing animals.

HARNESSES

LANYARDS & SHOCK ABSORBERS

CARABINERS

PULLEYS

ASCENDERS

DESCENDERS

HELMETS

MOBILE FALL ARRESTERS

RETRACTABLE FALL ARRESTERS

RESCUE DEVICES

STRETCHERS

ROPES

BAGS AND ACCESSORIES

SAFETY NETS

EDGE PROTECTION

TRIPOD AND CANTILEVER ARMS

ANCHORAGES

HORIZONTAL LIFELINE

VERTICAL LIFELINE

DEFENCE

LIFTING EQUIPMENT

POWER INDUSTRY SAFETY HARNESS KEY FEATURES



Special Design, Easy use, Aluminum Alloy D-Rings.

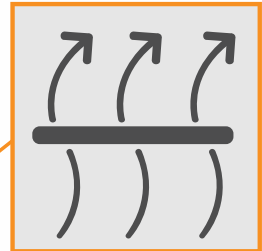

Antibacterial and Ergonomic Pads.



Easy Use Steel Tongue Buckles.



Sewing with Bonded Type Yarn in Computerized CNC Machines.



Easy Use, Aluminum, Automatic Buckles with indicator.

FALL ARREST AND WORK POSITIONING SUSPENSION HARNESSSES



The protective case protects the information tag visually and enables users to log annual inspections.



Comes with 4 pcs of tool holders with a carrying capacity of 25 kg each.



Special Design, Easy use, Aluminum Alloy Bent D-Rings.



Elastic webbings for work positioning.



HARNESSES

LANYARDS & SHOCK ABSORBERS

CARABINERS

PULLEYS

ASCENDERS

DESCENDERS

HELMETS

MOBILE FALL ARRESTERS

RETRACTABLE FALL ARRESTERS

RESCUE DEVICES

STRETCHERS

ROPES

BAGS AND ACCESSORIES

SAFETY NETS

EDGE PROTECTION

TRIPOD AND CANTILEVER ARMS

ANCHORAGES

HORIZONTAL LIFELINE

VERTICAL LIFELINE

DEFENCE

LIFTING EQUIPMENT



POWER INDUSTRY

FALL ARREST AND WORK POSITIONING SUSPENSION HARNESS

- Designed for fall arrest, rope access, restraint, work positioning, climbing, controlled descent and rescue purposes.
- Has 5 attachment points;
 - 1 x Dorsal and 1 Sternal D - Ring for Fall Arrest
 - 1 x Ventral D - Ring at waist level for Rope Access work
 - 2 x Lateral D - Rings for Work Positioning
- Includes fall indicators on the sternal and dorsal attachment points. If a fall indicator is visible after a fall, the harness must be retired.
- Suspension leg straps allows for increased comfort.
- Maximum comfort by breathing, antibacterial and ergonomic waist, leg and shoulder pad.
- Easy use aluminum automatic buckles for fast connection and release.
- Easy use and ergonomic steel buckles on waist and shoulder.
- UV resistant high strength bonded type sewing yarns and contrastive color sewing in CNC machineries for quick eye control.
- 4 gear loops on waist belt.
- The protective case protects the information tag visually and enables users to log annual inspections.

Size : S/M, L/XL, XXL

Standard: EN 361, EN 358, EN 813, EN 12277



POWER ACCESS
ROPE ACCESS SUSPENSION HARNESS

- Designed for rope access, fall arrest, restraint and work positioning purposes.
- Has 5 attachment points;
1 x Dorsal and 1 Sternal D - Ring for Fall Arrest.
1 x Ventral D - Ring at waist level for Rope Access work.
2 x Lateral D - Rings for Work Positioning.
- Equipped with integrated Chest Ascender.
- Includes fall indicators on the sternal and dorsal attachment points. If a fall indicator is visible after a fall, the harness must be retired.
- In case of a fall, Sternal D - Ring enables users' legs move upward to a sternal position to ensure a vertical post-fall body position and to prevent suspension trauma.
- Suspension leg straps allows for increased comfort.
- Maximum comfort by breathing, antibacterial and ergonomic waist, leg and shoulder pads.
- Easy use aluminum automatic buckles for fast connection and release. Equipped with visual locking indicator.
- Easy use and ergonomic steel buckles on waist and shoulder.
- UV resistant high strength bonded type sewing yarns and contrastive color sewing in CNC machineries for quick eye control.
- 4 gear loops on waist belt.
- The protective case protects the information tag visually and enables users to log annual inspections.

Size : S/M, L/XL, XXL
Standard: EN 361, EN 358, EN 813, EN 12277

HARNESSES

LANYARDS & SHOCK ABSORBERS

CARBINERS

PULLEYS

ASCENDERS

DESCENDERS

HELMETS

MOBILE FALL ARRESTERS

RETRACTABLE FALL ARRESTERS

RESCUE DEVICES

STRETCHERS

ROPES

BAGS AND ACCESSORIES

SAFETY NETS

EDGE PROTECTION

TRIPOD AND CANTILEVER ARMS

ANCHORAGES

HORIZONTAL LIFELINE

VERTICAL LIFELINE

DEFENCE

LIFTING EQUIPMENT



P-455 YO

FALL ARREST AND WORK POSITIONING SUSPENSION HARNESS

- Designed for fall arrest, rope access, restraint, work positioning, controlled descent and rescue purposes.
- Has 5 attachment points;
1 x Dorsal and 1 Sternal D - Ring for Fall Arrest.
1 x Ventral D - Ring at waist level for Rope Access work.
2 x Lateral D - Rings for Work Positioning.
- Suspension leg straps allows for increased comfort.
- Maximum comfort by breathing, antibacterial and ergonomic waist, leg and shoulder pads.
- Easy use aluminum automatic buckles for fast connection and release. Equipped with visual locking indicator.
- Easy use and ergonomic steel buckles on shoulder.
- UV resistant high strength bonded type sewing yarns and contrastive color sewing in CNC machineries for quick eye control.
- 4 gear loops on waist belt.
- The protective case protects the information tag visually and enables users to log annual inspections.

Size : S/M, L/XL, XXL

Standard: EN 361, EN 358, EN 813, EN 12277



P-455 Y

FALL ARREST AND WORK POSITIONING SUSPENSION HARNESS

- Designed for fall arrest, rope access, restraint, work positioning, controlled descent and rescue purposes.
- Has 5 attachment points;
1 x Dorsal and 1 Sternal D - Ring for Fall Arrest.
1 x Ventral D - Ring at waist level for Rope Access work.
2 x Lateral D - Rings for Work Positioning.
- Suspension leg straps allows for increased comfort.
- Maximum comfort by breathing, antibacterial and ergonomic waist, leg and shoulder pads.
- Easy use and ergonomic steel buckles.
- UV resistant high strength bonded type sewing yarns and contrastive color sewing in CNC machineries for quick eye control.
- 4 gear loops on waist belt.
- The protective case protects the information tag visually and enables users to log annual inspections.

Size : S/M, L/XL, XXL

Standard: EN 361, EN 358, EN 813, EN 12277

HARNESSES

LANYARDS & SHOCK ABSORBERS

CARABINERS

PULLEYS

ASCENDERS

DESCENDERS

HELMETS

MOBILE FALL ARRESTERS

RETRACTABLE FALL ARRESTERS

RESCUE DEVICES

STRETCHERS

ROPES

BAGS AND ACCESSORIES

SAFETY NETS

EDGE PROTECTION

TRIPOD AND CANTILEVER ARMS

ANCHORAGES

HORIZONTAL LIFELINE

VERTICAL LIFELINE

DEFENCE

LIFTING EQUIPMENT



P-455 YOB
WORK POSITIONING
SUSPENSION HARNESS

- Designed for restraint, work positioning and rescue purposes.
- 2 x Lateral D - Rings for Work Positioning.
- 1 x Ventral D - Ring at waist level for Rope Access and rescue work.
- Suspension leg straps allows for increased comfort.
- Maximum comfort by breathing, antibacterial and ergonomic waist and leg pads.
- Used as fall arrest and work positioning harness when integrated with P-455 YU.
- Special design aluminum D Rings.
- Easy use aluminum automatic buckles for fast connection and release. Equipped with visual locking indicator.
- UV resistant high strength bonded type sewing yarns and contrastive color sewing in CNC machineries for quick eye control.
- 4 gear loops on waist belt.

Size : S/M, L/XL, XXL
Standard: EN 358, EN 12277



P-455 YB
WORK POSITIONING
SUSPENSION HARNESS

- Designed for restraint, work positioning and rescue purposes.
- 2 x Lateral D - Rings for Work Positioning.
- 1 x Ventral D - Ring at waist level for Rope Access and rescue work.
- Suspension leg straps allows for increased comfort.
- Maximum comfort by breathing, antibacterial and ergonomic waist and leg pads.
- Used as fall arrest and work positioning harness when integrated with P-455 YU.
- Special design aluminum D Rings.
- Easy use steel buckles for fast connection and release.
- UV resistant high strength bonded type sewing yarns and contrastive color sewing in CNC machineries for quick eye control.
- 4 gear loops on waist belt.

Size : S/M, L/XL, XXL
Standard: EN 358, EN 12277



P-455 YU
UPPER HARNESS

- Designed for restraint, work positioning and rescue purposes.
- Used as fall arrest and work positioning harness when integrated either with P-455 YB or P-455 YOB.
- 1 x Sternal D - Ring.
- 1 x Dorsal D - Ring.
- Maximum comfort by breathing, antibacterial and ergonomic shoulder pads.
- Easy use steel buckles for fast connection and release.
- UV resistant high strength bonded type sewing yarns and contrastive color sewing in CNC machineries for quick eye control.

Size: S/M, L/XL, XXL



CA-2



TS-30

CA-2
CHEST ASCENDER KIT

- Designed for rope ascent with a chest rope clamp. The low attachment point allows for a fast and energy saving ascent.

Weight: 353 gr

TS-30
SUSPENSION TRAUMA STRAPS

- Designed to prevent suspension trauma while a worker is awaiting rescue.
- Helps suspended users to overcome the potential negative health impacts of suspension trauma.
- Made of 30 mm High Tenacity Webbing.
- Comes with fast adjustable buckles attached to the webbing.

Weight: 188 gr (2 pcs)



(TS-30) SUSPENSION TRAUMA STRAPS



STAR
BOSUN'S CHAIR

- Ideal for working short or extended periods in suspension; windows cleaning, maintenance, painting etc.
- Adjustable QB-25 Quick Buckles.
- 3 x gear loops.
- Does not provide any fall protection and must be used with an appropriate fall arrest and rescue system.

Weight: 1.420 gr



STAR COMFORT
BOSUN'S CHAIR

- Ideal for working short or extended periods in suspension; windows cleaning, maintenance, painting etc.
- Wide sitting area provides comfortable sitting and working position.
- Webbing ladder for resting.
- 3 x gear loops.
- Does not provide any fall protection and must be used with an appropriate fall arrest and rescue system.

Weight: 1.530 gr

HARNESSES

LANYARDS & SHOCK ABSORBERS

CARABINERS

PULLEYS

ASCENDERS

DESCENDERS

HELMETS

MOBILE FALL ARRESTERS

RETRACTABLE FALL ARRESTERS

RESCUE DEVICES

STRETCHERS

ROPES

BAGS AND ACCESSORIES

SAFETY NETS

EDGE PROTECTION

TRIPOD AND CANTILEVER ARMS

ANCHORAGES

HORIZONTAL LIFELINE

VERTICAL LIFELINE

DEFENCE

LIFTING EQUIPMENT



P-453 O
FALL ARREST AND WORK POSITIONING HARNESS

- Designed for fall arrest, restraint and work positioning purposes.
- Has 4 attachment points;
1 x Dorsal and 1 Sternal D - Ring for Fall Arrest.
2 x Lateral D - Rings for Work Positioning.
- Maximum comfort by breathing, antibacterial and ergonomic waist, leg and shoulder pads.
- Easy use aluminum automatic buckles for fast connection and release. Equipped with visual locking indicator.
- Easy use and ergonomic steel buckles on shoulder.
- UV resistant high strength bonded type sewing yarns and contrastive color sewing in CNC machineries for quick eye control.
- 4 gear loops on waist belt.
- The protective case protects the information tag visually and enables users to log annual inspections.

Size : S/M, L/XL, XXL
Standard: EN 361, EN 358



P-451 PO
FALL ARREST AND WORK POSITIONING HARNESS

- Designed for fall arrest and to restrain a person in a hazardous work position and to reduce the possibility of fall.
- Has 2 attachment points;
1 x Dorsal and 1 Sternal D - Ring for Fall Arrest.
- Maximum comfort by breathing, antibacterial and ergonomic leg and shoulder pads.
- Easy use aluminum automatic buckles for fast connection and release. Equipped with visual locking indicator.
- Easy use and ergonomic steel buckles on shoulder.
- UV resistant high strength bonded type sewing yarns and contrastive color sewing in CNC machineries for quick eye control.
- The protective case protects the information tag visually and enables users to log annual inspections.

Size : S/M, L/XL, XXL
Standard: EN 361



J-45 FALL ARREST HARNESS (JACKET TYPE)

- Designed for fall arrest purpose.
- 1 x Dorsal D - Ring for Fall Arrest.
- 1 x K-2 oval shape carabiner for chest connection.
- 2 x A/2 safe connection point.
- Easy use adjustable buckles.
- Integrated Vest.
- UV resistant high strength bonded type sewing yarns and contrastive color sewing in CNC machineries for quick eye control.

Size : S/M, L/XL, XXL
Standard: EN 361



P-451 PO-AS FALL ARREST AND WORK POSITIONING HARNESS

- Ideal solution for safe work at height in explosive atmospheres. It is particularly suitable for petrochemical and mining industry.
- The anti-static material prevents the risk of an electrostatic discharge igniting the explosive atmosphere thus allowing the user to work in complete safety in these high risk environments.
- Extension strap on dorsal D-Ring.
- 1 x Dorsal and 1 Sternal D - Ring for Fall Arrest.
- Maximum comfort by breathing, antibacterial and ergonomic leg and shoulder pads.
- Easy use aluminum automatic buckles for fast connection and release. Equipped with visual locking indicator.
- Easy use and ergonomic steel buckles on shoulder.
- UV resistant high strength bonded type sewing yarns and contrastive color sewing in CNC machineries for quick eye control
- The protective case protects the information tag visually and enables users to log annual inspections.

Size : S/M, L/XL, XXL
Standard: EN 361

HARNESSES

LANYARDS &
SHOCK ABSORBERS

CARABINERS

PULLEYS

ASCENDERS

DESCENDERS

HELMETS

MOBILE FALL
ARRESTERS

RETRACTABLE
FALL ARRESTERS

RESCUE DEVICES

STRETCHERS

ROPES

BAGS AND
ACCESSORIES

SAFETY NETS

EDGE PROTECTION

TRIPOD AND
CANTILEVER ARMS

ANCHORAGES

HORIZONTAL
LIFELINE

VERTICAL LIFELINE

DEFENCE

LIFTING
EQUIPMENT



B-452 TO

WORK POSITIONING HARNESS (TELECOM TYPE)

- Designed for fall arrest and to restrain a person in a hazardous work position and to reduce the possibility of fall.
- 2 x Lateral D - Rings on waist pad.
- Maximum comfort by breathing, antibacterial and ergonomic leg and waist pads.
- Easy use aluminum automatic buckles for fast connection and release. Equipped with visual locking indicator
- UV resistant high strength bonded type sewing yarns and contrastive color sewing in CNC machineries for quick eye control.

Size : S/M, L/XL, XXL
Standard: EN 358



BD-85



BK-85 A

BD-85

WORK POSITIONING HARNESS (ELECTRICIAN TYPE)

- Designed for fall arrest and to restrain a person in a hazardous work position and to reduce the possibility of fall.
- Maximum comfort by breathing, antibacterial and ergonomic waist pad.
- 2 x 85 mm Lateral D - Rings on waist pad for work positioning.
- Easy use adjustable buckles.
- UV resistant high strength bonded type sewing yarns and contrastive color sewing in CNC machineries for quick eye control.

Size : S/M, L/XL
Standard: EN 358

BK-85 A

WORK POSITIONING HARNESS

- Designed to restrain a person in a hazardous work position and to reduce the possibility of fall.
- Maximum comfort by breathing, antibacterial and ergonomic waist pad.
- 2 x 85 mm Lateral D - Rings on waist pad for work positioning.
- Easy use adjustable buckles.
- UV resistant high strength bonded type sewing yarns and contrastive color sewing in CNC machineries for quick eye control.

Size : S/M, L/XL
Standard: EN 358



I-451 A



I-451

I-451 A

CLIMBING HARNESS

- 1 x Ventral textile connection point for climbing.
- Maximum comfort by breathing, antibacterial and ergonomic waist and leg pad.
- Easy use adjustable buckles.
- UV resistant high strength bonded type sewing yarns and contrastive color sewing in CNC machineries for quick eye control.
- 4 gear loops on waist belt.

Size : S/M, L/XL

Standard: EN 12277

I-451

RESCUE HARNESS

- 1 x Special design ventral D-Ring for rescue.
- Maximum comfort by breathing, antibacterial and ergonomic waist and leg pad.
- Easy use adjustable buckles.
- UV resistant high strength bonded type sewing yarns and contrastive color sewing in CNC machineries for quick eye control.
- 4 gear loops on waist belt.

Size : S/M, L/XL

Standard: EN 12277



RT-3



RT-3 A

RT-3

RESCUE TRIANGLE

- Easy adjustment with buckles.
- Multi connection points.

Size : S/M, L/XL

Standard: EN 1498

RT-3 A

RESCUE TRIANGLE WITH SHOULDER STRAP

- Specially designed for rescue operations.
- Easy to put on with its shoulder straps.
- Easy adjustment with QB-45 quick buckles.

Size : S/M, L/XL

Standard: EN 1498

HARNESSES

LANYARDS & SHOCK ABSORBERS

CARABINERS

PULLEYS

ASCENDERS

DESCENDERS

HELMETS

MOBILE FALL ARRESTERS

RETRACTABLE FALL ARRESTERS

RESCUE DEVICES

STRETCHERS

ROPES

BAGS AND ACCESSORIES

SAFETY NETS

EDGE PROTECTION

TRIPOD AND CANTILEVER ARMS

ANCHORAGES

HORIZONTAL LIFELINE

VERTICAL LIFELINE

DEFENCE

LIFTING EQUIPMENT



FB-50



FB-50 L



FB-50
FORRESTER BELT

- 1 X 45 mm 316 grade stainless d-ring.
- 50 mm heat-resistant kevlar webbing.
- High visibility reflector band.
- 1 X 45 mm 316 grade stainless buckle.

Size : S/M, L/XL
Standard: ISO 9001:2008

FB-50 L
FORRESTER BELT WITH LANYARD

- 1 X 45 mm 316 grade stainless d-ring.
- 50 mm heat-resistant kevlar webbing.
- High visibility reflector band.
- 1 X 45 mm 316 grade stainless buckle.
- 1,2 Mt kevlar lanyard with carabiner.

Size : S/M, L/XL
Standard: ISO 9001:2008

BD-85 F
FIREMAN BELT

- 1 X wide aluminum d ring.
- 85 mm polyester webbing.
- Leather covered pinning area.
- 1 X 85mm tongue buckle.
- 1,2 Meter leather covered lanyard with carabineer.

Size : S/M, L/XL
Standard: EN 358, EN 354

P-453 F
FIREMAN HARNESS

- Heat and flame proof Full Body Harness is ideal for rescue in high temperature environments.
- Maximum comfort by wide, semi-rigid, ergonomic, heat and flame proof waist pad.
- 1X dorsal D-ring.
- In work positioning weight is distributed equally around the waist by side connection points.
- Easy adjustable buckles.
- Stainless steel metal parts.

Size : S/M, L/XL, XXL
Standard: EN 361, EN 358



M-85 AS
ANTI-STATIC MINERS BELT

- Ideal for working environments where there is flare and explosion risk.
- Maximum comfort by virtue of Breathing, Antibacterial & Ergonomic Waist Pad.
- High visibility in dark environments by reflector bands.
- Special holders to carry respirator set and head lamp battery.
- AB-45 stainless steel buckles
- UV Resistant high strength bonded type yarns and contrastive color sewing for quick eye control.

Size : S/M, L/XL
Standard: EN 13463-1, ATEX



BM-45 A
MINERS BELT

- Maximum comfort by virtue of Breathing, Antibacterial & Ergonomic Waist Pad.
- Easy use with shoulder straps.
- Stainless steel metal components.
- Easy adjustable buckles.
- High visibility in dark environments by reflector bands.
- UV Resistant high strength bonded type yarns and contrastive color sewing for quick eye control.

Size : S/M, L/XL
Standard: ISO 9001:2008



SB-2



SB-3

SB-2
MINERS BELT

- Special holders to carry respirator set and head lamp battery.
- 2 x 316 grade stainless steel D rings.
- 45 mm high tenacity polyester webbing.
- Leather covered webbing.
- UV Resistant high strength bonded type yarns and contrastive color sewing for quick eye control.

Size : S/M, L/XL
Standard: ISO 9001:2008

SB-3
MINERS BELT

- Ideal for restraint in mines.
- Special holders to carry respirator set and head lamp battery.
- 1 x 316 grade stainless steel D ring.
- 45 mm high tenacity polyester webbing.
- Leather covered webbing.
- UV Resistant high strength bonded type yarns and contrastive color sewing for quick eye control.

Weight : 495 gr
Standard: ISO 9001:2008



HARNESSES

LANYARDS & SHOCK ABSORBERS

CARABINERS

PULLEYS

ASCENDERS

DESCENDERS

HELMETS

MOBILE FALL ARRESTERS

RETRACTABLE FALL ARRESTERS

RESCUE DEVICES

STRETCHERS

ROPES

BAGS AND ACCESSORIES

SAFETY NETS

EDGE PROTECTION

TRIPOD AND CANTILEVER ARMS

ANCHORAGES

HORIZONTAL LIFELINE

VERTICAL LIFELINE

DEFENCE

LIFTING EQUIPMENT



C&H-80

LARGE ANIMAL RESCUE HARNESS

- Ideal solution for rescuing large animals such as cows and horses.
- 2 x 85mm wide suspension slings.
- 2 x 80 mm wide body and chest webbings to make the lifting process comfortable.
- Adjustable QB-45 quick buckles.
- Packed in its own special bag.

Weight : 5.510 gr
Standard: ISO 9001:2008



DH-30



DH-40

DH-30

DOG RESCUE HARNESS

- Designed to carry search & rescue dogs.
- Ideal for transporting by helicopter.
- Adjustable buckles enables it to be used for dogs of different sizes.
- Easy clean & changeable support pads.
- Very light and takes up less space.

Weight : 1.110 gr
Standard: ISO 9001:2008

DH-40

DOG CARRY HARNESS

- Designed to carry search & rescue dogs.
- Ideal for transporting by helicopter.
- Adjustable shoulder straps make it easy to lift, position and control your dog during the evolution.
- Foam pillow suspends the dog in a comfortable position.
- Has Anti-Bacterial and Breathable carry pads.

Weight : 1.530 gr
Standard: ISO 9001:2008

HARNESSES

LANYARDS & SHOCK ABSORBERS

CARABINERS

PULLEYS

ASCENDERS

DESCENDERS

HELMETS

MOBILE FALL ARRESTERS

RETRACTABLE FALL ARRESTERS

RESCUE DEVICES

STRETCHERS

ROPES

BAGS AND ACCESSORIES

SAFETY NETS

EDGE PROTECTION

TRIPOD AND CANTILEVER ARMS

ANCHORAGES

HORIZONTAL LIFELINE

VERTICAL LIFELINE

DEFENCE

LIFTING EQUIPMENT



BC-46 P BOSUN'S CHAIR PROFESSIONAL (MARINE USE)

- Comfortable working position.
- 2 x tool bags.
- Stainless steel metal parts.
- One hand operation AB-45 automatic buckle.
- UV resistant high strength bonded yarns and contrastive color sewing for quick eye control.

Weight : 2.230 gr
Standard: ISO 9001:2008



BC-46 C BOSUN'S CHAIR COMFORT (MARINE USE)

- Comfortable working position.
- 2 x tool bags.
- Stainless steel metal parts.
- Easy adjustable buckles.
- UV resistant high strength bonded yarns and contrastive color sewing for quick eye control.











Weight : 2.230 gr
Standard: ISO 9001:2008















BM-45 SAFETY HARNESS (MARINE USE)

- Comfortable working position.
- Stainless steel metal parts.
- Easy adjustable buckles.
- UV resistant high strength bonded yarns and contrastive color sewing for quick eye control.

Size : S/M, L/XL
Weight : 510 gr(S/M), 550 gr(L/XL)
Standard: ISO 9001:2008

PRODUCT	PRODUCT CODE	SIZE	STANDARD	ANCHORAGE POINT					DIMENSIONS			WEIGHT
				DORSAL (EN 361)	STERNAL (EN 361)	LATERAL (EN 358)	VENTRAL (EN 813)	VENTRAL (EN 12277)	WAIST	LEG	HEIGHT	
	POWER INDUSTRY	S/M	EN 361	✓	✓	✓	✓	✓	65 - 95 cm	45 - 65 cm	155 – 175 cm	2,350 kg
		L/XL	EN 358 EN 813	✓	✓	✓	✓	✓	75 - 115 cm	60 - 70 cm	175 – 190 cm	2,430 kg
		XXL	EN 12277	✓	✓	✓	✓	✓	85 - 135 cm	65 - 80 cm	180 – 200 cm	2,610 kg
	POWER ACCESS	S/M	EN 361	✓	✓	✓	✓	✓	65 - 95 cm	45 - 65 cm	155 – 175 cm	2,363 kg
		L/XL	EN 358 EN 813	✓	✓	✓	✓	✓	75 - 115 cm	60 - 70 cm	175 – 190 cm	2,455 kg
		XXL	EN 12277	✓	✓	✓	✓	✓	85 - 135 cm	65 - 80 cm	180 – 200 cm	2,564 kg
	P-455 YO	S/M	EN 361	✓	✓	✓	✓	✓	65 - 95 cm	45 - 65 cm	155 – 175 cm	2,110 kg
		L/XL	EN 358 EN 813	✓	✓	✓	✓	✓	75 - 115 cm	60 - 70 cm	175 – 190 cm	2,190 kg
		XXL	EN 12277	✓	✓	✓	✓	✓	85 - 135 cm	65 - 80 cm	180 – 200 cm	2,260 kg
	P-455 Y	S/M	EN 361	✓	✓	✓	✓	✓	65 - 95 cm	45 - 65 cm	155 – 175 cm	1,878 kg
		L/XL	EN 358 EN 813	✓	✓	✓	✓	✓	75 - 115 cm	60 - 70 cm	175 – 190 cm	1,970 kg
		XXL	EN 12277	✓	✓	✓	✓	✓	85 - 135 cm	65 - 80 cm	180 – 200 cm	2,079 kg
	P-455 YU	S/M	-	-	-	-	-	-	-	-	175 – 190 cm	0,568 kg
		L/XL	-	-	-	-	-	-	-	-	180 – 195 cm	0,660 kg
		XXL	-	-	-	-	-	-	-	-	180 – 200 cm	0,760 kg
	P-455 YOB	S/M	-	-	✓	-	✓	65 - 95 cm	45 - 65 cm	155 – 175 cm	1,492 kg	
		L/XL	EN 358 EN 12277	-	-	✓	-	✓	75 - 115 cm	60 - 70 cm	175 – 190 cm	1,584 kg
		XXL	-	-	✓	-	✓	85 - 135 cm	65 - 80 cm	180 – 200 cm	1,692 kg	
	P-455 YB	S/M	-	-	✓	-	✓	65 - 95 cm	45 - 65 cm	155 – 175 cm	1,218 kg	
		L/XL	EN 358 EN 12277	-	-	✓	-	✓	75 - 115 cm	60 - 70 cm	175 – 190 cm	1,310 kg
		XXL	-	-	✓	-	✓	85 - 135 cm	65 - 80 cm	180 – 200 cm	1,419 kg	
	P-453 O	S/M	EN 361 EN 358	✓	✓	✓	-	-	65 - 95 cm	45 - 65 cm	155 – 175 cm	2,080 kg
		L/XL	-	✓	✓	✓	-	-	75 - 115 cm	60 - 70 cm	175 – 190 cm	2,160 kg
		XXL	-	✓	✓	✓	-	-	85 - 135 cm	65 - 80 cm	180 – 200 cm	2,230 kg
	P-451 PO	S/M	EN 361	✓	✓	-	-	-	-	45 - 65 cm	155 – 175 cm	1,490 kg
		L/XL	-	✓	✓	-	-	-	-	60 - 70 cm	175 – 190 cm	1,560 kg
		XXL	-	✓	✓	-	-	-	-	65 - 80 cm	180 – 200 cm	1,640 kg
	J-45	S/M	EN 361	✓	✓	-	-	-	-	45 - 65 cm	155 – 175 cm	1,071 kg
		L/XL	-	✓	✓	-	-	-	-	60 - 70 cm	175 – 190 cm	1,163 kg
		XXL	-	✓	✓	-	-	-	-	65 - 80 cm	180 – 200 cm	1,272 kg

PRODUCT	PRODUCT CODE	SIZE	STANDARD	ANCHORAGE POINT					DIMENSIONS			WEIGHT
				DORSAL (EN 361)	STERNAL (EN 361)	LATERAL (EN 358)	VENTRAL (EN 813)	VENTRAL (EN 12277)	WAIST	LEG	HEIGHT	
	B-452 TO	S/M	EN 358	-	-	√	-	-	65 - 95 cm	45 - 65 cm	155 - 175 cm	1,190 kg
		L/XL		-	-	√	-	-	75 - 115 cm	60 - 70 cm	175 - 190 cm	1,282 kg
	BD-85	S/M	EN 358	-	-	√	-	-	65 - 95 cm	45 - 65 cm	155 - 175 cm	1,259 kg
		L/XL		-	-	√	-	-	75 - 115 cm	60 - 70 cm	175 - 190 cm	1,325 kg
	FB-50	S/M	-	-	-	-	-	-	65 - 95 cm	45 - 65 cm	155 - 175 cm	0,243 kg
		L/XL		-	-	-	-	-	75 - 115 cm	60 - 70 cm	175 - 190 cm	0,285 kg
	FB-50 L	S/M	-	-	-	-	-	-	65 - 95 cm	45 - 65 cm	155 - 175 cm	0,678 kg
		L/XL		-	-	-	-	-	75 - 115 cm	60 - 70 cm	175 - 190 cm	0,720 kg
	BD-85 F	S/M	EN 358	-	-	√	-	-	65 - 95 cm	45 - 65 cm	155 - 175 cm	1,073 kg
		L/XL		-	-	√	-	-	75 - 115 cm	60 - 70 cm	175 - 190 cm	1,165 kg
	P-453 F	S/M	EN 361 EN 358	√	√	√	-	-	65 - 95 cm	45 - 65 cm	155 - 175 cm	1,564 kg
		L/XL		√	√	√	-	-	75 - 115 cm	60 - 70 cm	175 - 190 cm	1,656 kg
		XXL		√	√	√	-	-	85 - 135 cm	65 - 80 cm	180 - 200 cm	1,765 kg
	M-85 AS	S/M	EN 13463-1	-	-	-	-	-	65 - 95 cm	45 - 65 cm	155 - 175 cm	0,528 kg
		L/XL		-	-	-	-	-	75 - 115 cm	60 - 70 cm	175 - 190 cm	0,570 kg
	BM-45 A	S/M	-	-	-	-	-	-	65 - 110 cm	50 - 65 cm	155 - 175 cm	0,764 kg
		L/XL		-	-	-	-	-	75 - 135 cm	60 - 70 cm	175 - 190 cm	0,806 kg
	SB-2	S/M	-	-	-	-	-	-	65 - 95 cm	45 - 65 cm	155 - 175 cm	0,416 kg
		L/XL		-	-	-	-	-	75 - 115 cm	60 - 70 cm	175 - 190 cm	0,458 kg
	SB-3	S/M	-	-	-	-	-	-	65 - 95 cm	45 - 65 cm	155 - 175 cm	0,500 kg
		L/XL		-	-	-	-	-	75 - 115 cm	60 - 70 cm	175 - 190 cm	0,542 kg
	I-451	S/M	EN 12277	-	-	-	-	√	65 - 95 cm	45 - 65 cm	155 - 175 cm	0,900 kg
		L/XL		-	-	-	-	√	75 - 115 cm	60 - 70 cm	175 - 190 cm	0,967 kg
	I-451 A	S/M	EN 12277	-	-	-	-	√	65 - 95 cm	45 - 65 cm	155 - 175 cm	0,594 kg
		L/XL		-	-	-	-	√	75 - 115 cm	60 - 70 cm	175 - 190 cm	0,660 kg
	RT-3 A	S/M	EN 1496	-	-	-	-	-				1,048 kg
		L/XL		-	-	-	-	-				1,140 kg
	RT-3	S/M	EN 1496	-	-	-	-	-				0,850 kg
		L/XL		-	-	-	-	-				0,940 kg





E-3 TB K-65/K-6A



E-1 TB K-65/K-6A

ELASTIC SHOCK ABSORBING LANYARDS (TIE-BACK)

Designed for tie-back use, eliminating the need for a separate anchorage connector. It offers complete freedom of movement while reducing trip fall hazards by stretching in reaction to the worker's movements. The design is lightweight and provides max comfort and safety. The unique inner core begins to extend and absorb energy once subjected to a fall, and limits the fall arrest forces to safe levels. Available in single or twin - leg version.



EL-3 K-65/K-6A



EL-1 K-65/K-6A

ELASTIC SHOCK ABSORBING LANYARDS

Energy absorbing lanyards incorporate a unique stretchable design. It offers complete freedom of movement while reducing trip fall hazards by stretching in reaction to the worker's movements. The design is lightweight and provides max comfort and safety. The unique inner core begins to extend and absorb energy once subjected to a fall, and limits the fall arrest forces to safe levels. Available in single or twin - leg version.



E-3 W K-4A/K-6A



E-3 B K-4A/K-6A



E-3 T K-4A/K-6A



E-1 W K-4A/K-6A



E-1 B K-4A/K-6A



E-1 T K-4A/K-6A

SHOCK ABSORBING LANYARDS

These lanyards are generally used for tower climbing, steel erecting, scaffolding and maintenance on open structures. The lanyard is fitted with an energy absorber that reduces the impact force and the risk of injuries for the operator. The energy of the fall is absorbed by the tearing of specific webbing. The twin rebar hooks allows the user to maintain safe connection while moving around the structure. Available in twin or single - leg version.



WPL K-6A/K-7 3A



RAD K-6A/K-7 3A

ADJUSTABLE LANYARDS (WORK POSITIONING)

Adjustable lanyards are compact devices used for work positioning. It enables user to leave the hands free and to work in complete safety. Its ergonomic design makes it easy to use, ensuring adjustment is quick, accurate and flexible for greater comfort while working.



WPL WA K-6A

ADJUSTABLE LANYARDS (WOOD OR CONCRETE POLES)

This adjustable lanyard can be used for a variety of applications including: tower climbing, wind energy, wood and concrete pole climbing.



L-1 W K-4A/K-6A



L-1 B K-4A/K-6A



L-1 T K-4A/K-6A

SINGLE LEG LANYARDS

Allows workers to attach to an anchorage point and remain safe during their work. Recommended size for this type of lanyard is 1, 2 mt.



E-3 S K-65/K-6A



E-1 S K-65/K-6A

SHOCK ABSORBING WIRE ROPE LANYARDS

Allows workers to attach to an anchorage point and remain safe during their work. Made of stainless steel which enables it ideal for cutting trees or welding at height.

HARNESSES

LANYARDS & SHOCK ABSORBERS

CARABINERS

PULLEYS

ASCENDERS

DESCENDERS

HELMETS

MOBILE FALL ARRESTERS

RETRACTABLE FALL ARRESTERS

RESCUE DEVICES

STRETCHERS

ROPES

BAGS AND ACCESSORIES

SAFETY NETS

EDGE PROTECTION

TRIPOD AND CANTILEVER ARMS

ANCHORAGES

HORIZONTAL LIFELINE

VERTICAL LIFELINE

DEFENCE

LIFTING EQUIPMENT

EXAMPLE OF PRODUCT CODING

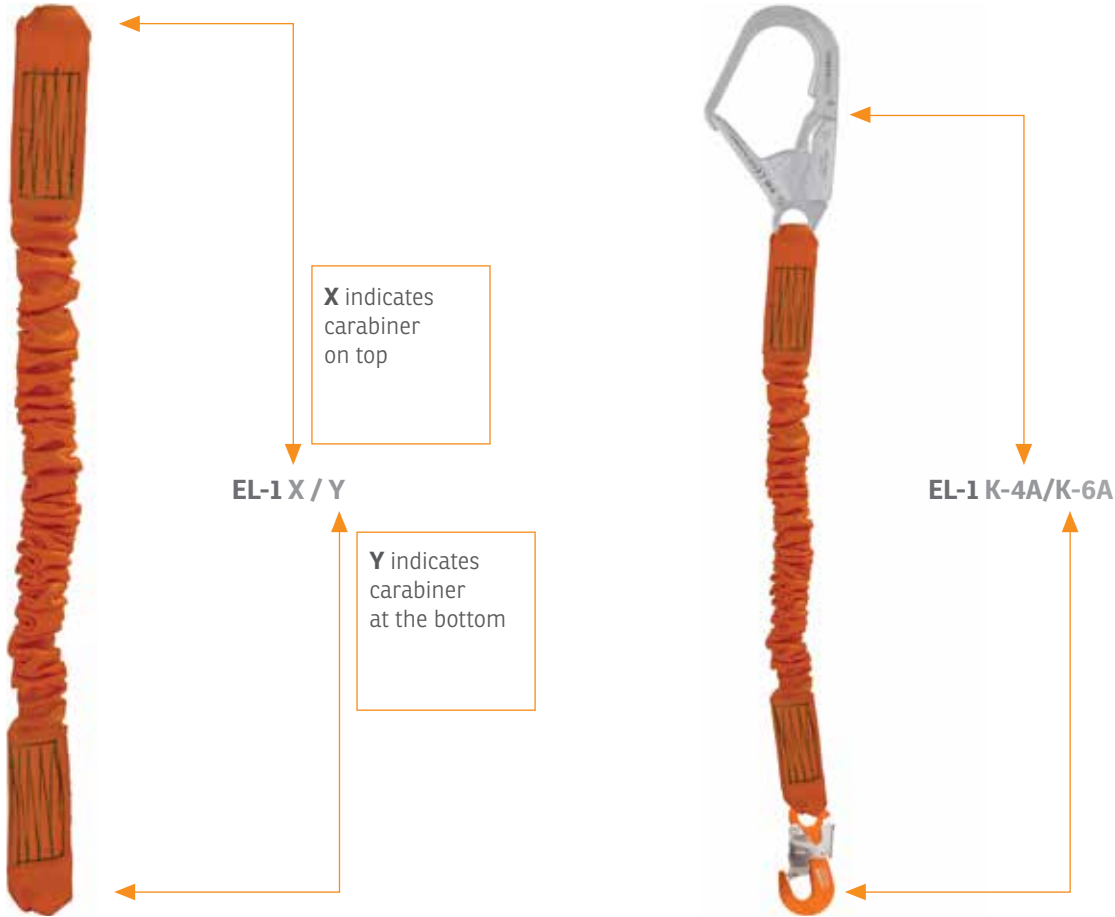

EL-1 SERIES

SINGLE-LEG ELASTIC SHOCK ABSORBING LANYARD

- Offers complete freedom of movement while reducing trip fall hazards by stretching in reaction to the worker's movements.
- Made of abrasion resistant polyester tubular webbing.
- Stitched in professional CNC machines by bonded type UV and dust resistant high tenacity yarn.
- Length after fall is 1,5 mt.

Models

- **EL-1** Shock absorbing lanyard only.
- **EL-1 K-6A/K-6A** Both end with **K-6A** type carabiner.
- **EL-1 K-65/K-6A** Bottom: **K-6A** type carabiner.
Top : **K-65** type carabiner.

Length : 1, 2 & 2 meter

Standard: EN 355, EN 362, EN 12275

CARABINER OPTIONS

For more information please refer to carabiners section.

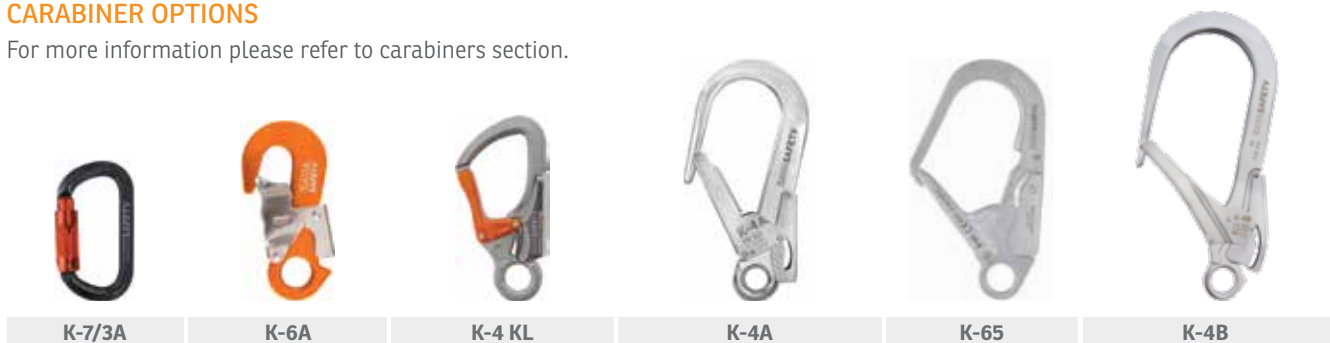

TWIN-LEG ELASTIC SHOCK ABSORBING LANYARDS

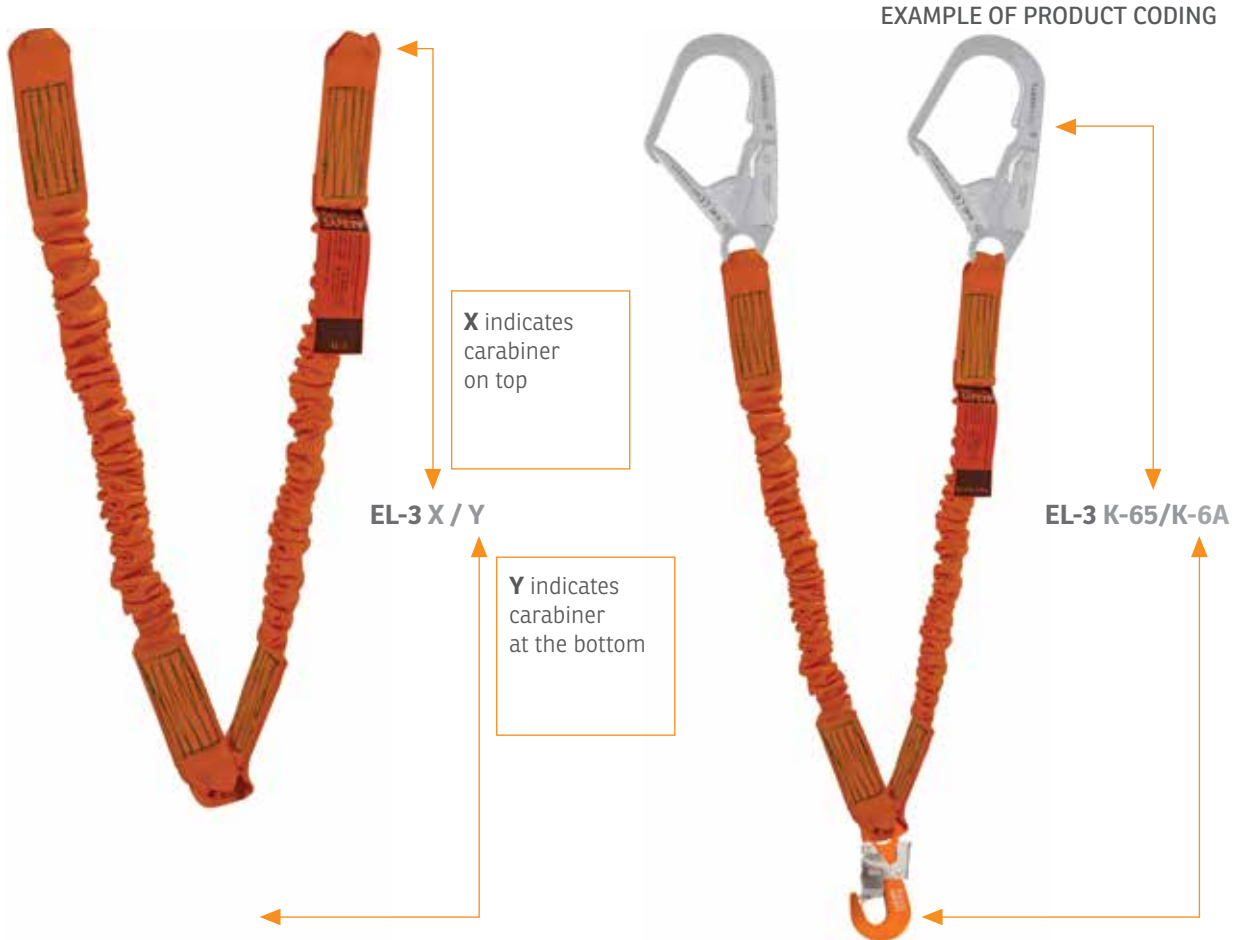

EL-3 SERIES

TWIN-LEG ELASTIC SHOCK ABSORBING LANYARD

- Offers complete freedom of movement while reducing trip fall hazards by stretching in reaction to the worker's movements.
- Twin-leg model allows user to keep one leg attached to the anchorage while the other leg is always ready to be hooked to the next anchorage.
- Made of abrasion resistant polyester tubular webbing.
- Stitched in professional CNC machines by bonded type UV and dust resistant high tenacity yarn.
- Rebar hook for use with anchor points requiring large gate opening.

Models

- **EL-3** Shock absorbing lanyard only.
- **EL-3 K-65/K-6A** Bottom : **K-6A** type carabiner.
Top : **K-65** type carabiner.
- **EL-3 K-6A/K-6A** Both end with **K-6A** type carabiner.

Length : 1, 2 & 2 meter

Standard: EN 355, EN 362, EN 12275

CARABINER OPTIONS

For more information please refer to carabiners section.

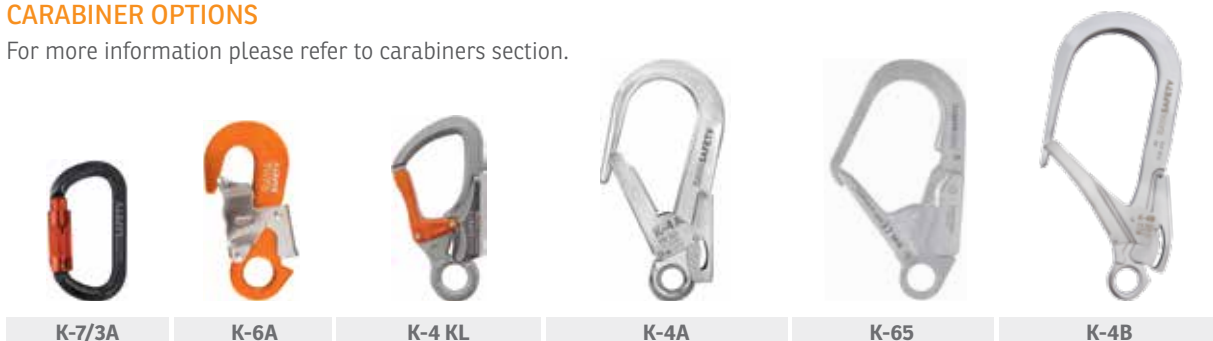

HARNESSES

LANYARDS & SHOCK ABSORBERS

CARABINERS

PULLEYS

ASCENDERS

DESCENDERS

HELMETS

MOBILE FALL ARRESTERS

RETRACTABLE FALL ARRESTERS

RESCUE DEVICES

STRETCHERS

ROPES

BAGS AND ACCESSORIES

SAFETY NETS

EDGE PROTECTION

TRIPOD AND CANTILEVER ARMS

ANCHORAGES

HORIZONTAL LIFELINE

VERTICAL LIFELINE

DEFENCE

LIFTING EQUIPMENT

EXAMPLE OF PRODUCT CODING



E-1 W SERIES

SINGLE – LEG SHOCK ABSORBING WEBBING LANYARD

- Allows workers to attach to an anchorage point and remain safe during their work.
- Made of highly resistant polyester webbing.
- Built-in energy absorber limits the fall arrest force in a fall situation by tearing specific seams.
- Zippered fabric case protects the energy absorber from abrasion and other damages while allowing for regular inspection of the absorber.
- Stitched in professional CNC machines by bonded type UV and dust resistant high tenacity yarn.

Models

- **E-1 W** Shock absorber and lanyard only.
- **E-1 W K-6A/K-6A** Both end with **K-6A** type carabiner.
- **E-1 W K-4A/K-6A** Bottom : **K-6A** type carabiner.
Top : **K-4A** type carabiner.

Length : 1, 2 & 2 meter

Standard: EN 354, EN 355, EN 362, EN 12275

CARABINER OPTIONS

For more information please refer to carabiners section.

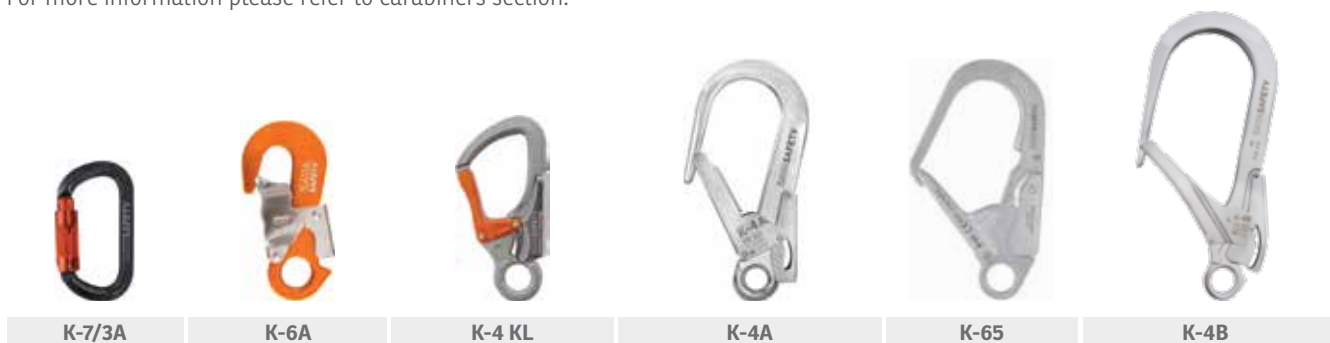

TWIN – LEG SHOCK ABSORBING WEBBING LANYARDS



E-3 W SERIES

TWIN-LEG SHOCK ABSORBING WEBBING LANYARDS

- Twin-leg model allows user to keep one leg attached to the anchorage while the other leg is always ready to be hooked to the next anchorage.
- Made of highly resistant polyester webbing.
- Built-in energy absorber limits the fall arrest force in a fall situation by tearing specific seams.
- Zippered fabric case protects the energy absorber from abrasion and other damages while allowing for regular inspection of the absorber.
- Stitched in professional CNC machines by bonded type UV and dust resistant high tenacity yarn.

CARABINER OPTIONS

For more information please refer to carabiners section.

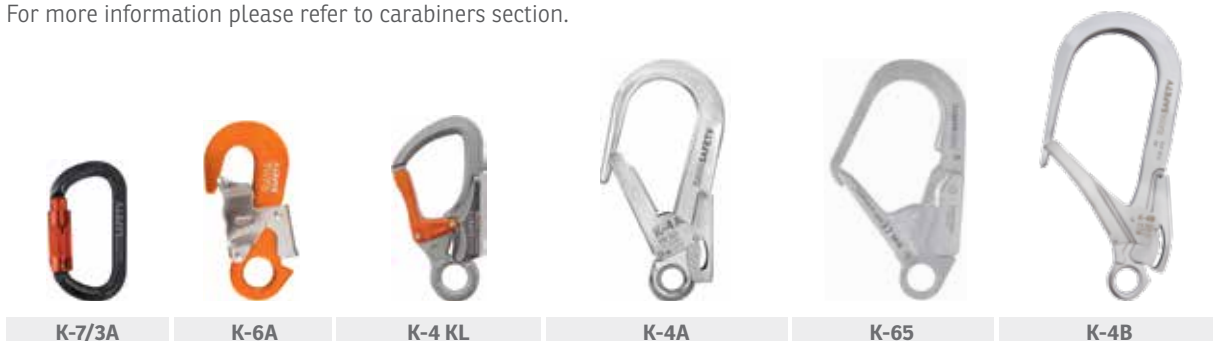

Models

- **E-3 W** Shock absorber and lanyard only.
- **E-3 W K-4A/K-6A** Bottom : **K-6A** type carabiner.
Top : **K-4A** type carabiner.
- **E-3 W K-6A/K-6A** Both end with **K-6A** type carabiner.

Length : 1, 2 & 2 meter

Standard: EN 354, EN 355, EN 362, EN 12275

HARNESSES

LANYARDS & SHOCK ABSORBERS

CARABINERS

PULLEYS

ASCENDERS

DESCENDERS

HELMETS

MOBILE FALL ARRESTERS

RETRACTABLE FALL ARRESTERS

RESCUE DEVICES

STRETCHERS

ROPES

BAGS AND ACCESSORIES

SAFETY NETS

EDGE PROTECTION

TRIPOD AND CANTILEVER ARMS

ANCHORAGES

HORIZONTAL LIFELINE

VERTICAL LIFELINE

DEFENCE

LIFTING EQUIPMENT

EXAMPLE OF PRODUCT CODING



E-1 B SERIES

SINGLE-LEG SHOCK ABSORBING BRAIDED ROPE LANYARD

- Allows workers to attach to an anchorage point and remain safe during their work.
- Made of 12 mm braided rope.
- Built-in energy absorber limits the fall arrest force in a fall situation by tearing specific seams.
- Zippered fabric case protects the energy absorber from abrasion and other damages while allowing for regular inspection of the absorber.
- Stitched in professional CNC machines by bonded type UV and dust resistant high tenacity yarn.

Models

- **E-1 B** Shock absorber and lanyard only.
- **E-1 B K-6A/K-6A** Both end with **K-6A** type carabiner.
- **E-1 B K-4A/K-6A** Bottom : **K-6A** type carabiner.
Top : **K-4A** type carabiner.

Length : 1, 2 & 2 meter

Standard: EN 354, EN 355, EN 362, EN 12275

CARABINER OPTIONS

For more information please refer to carabiners section.

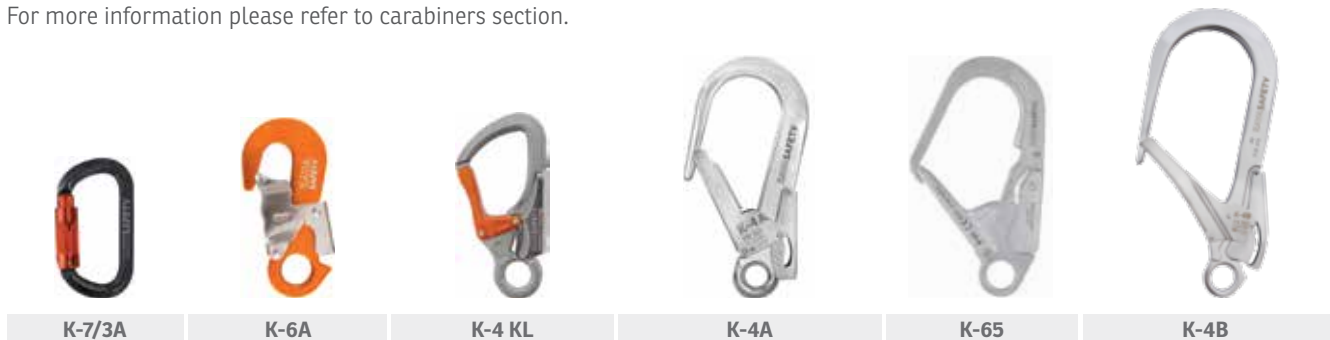

TWIN – LEG SHOCK ABSORBING BRAIDED ROPE LANYARDS



E-3 B SERIES

TWIN – LEG SHOCK ABSORBING BRAIDED ROPE LANYARD

- Twin-leg model allows user to keep one leg attached to the anchorage while the other leg is always ready to be hooked to the next anchorage.
- Built-in energy absorber limits the fall arrest force in a fall situation by tearing specific seams.
- Zippered fabric case protects the energy absorber from abrasion and other damages while allowing for regular inspection of the absorber.
- Stitched in professional CNC machines by bonded type UV and dust resistant high tenacity yarn.

Models

- **E-3 B** Shock absorber and lanyard only.
- **E-3 B K-4A/K-6A** Bottom : **K-6A** type carabiner.
Top : **K-4A** type carabiner.
- **E-3 B K-6A/K-6A** Both end with **K-6A** type carabiner.

CARABINER OPTIONS

For more information please refer to carabiners section.

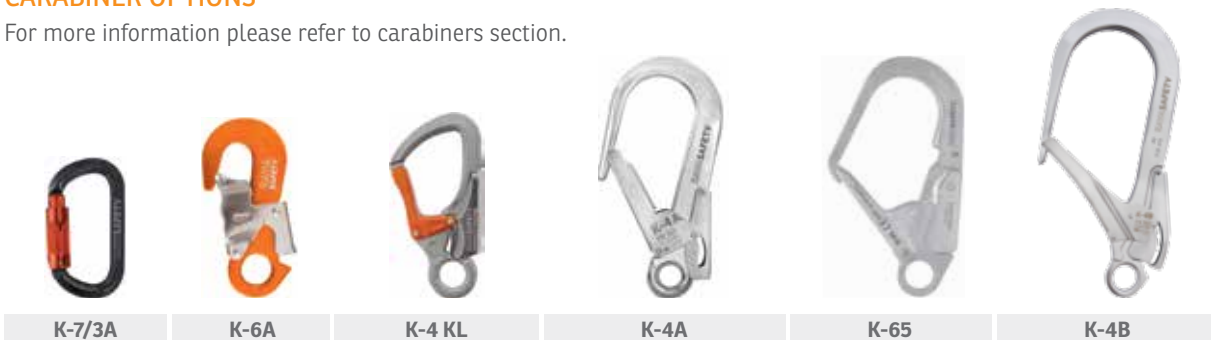

HARNESSES

LANYARDS & SHOCK ABSORBERS

CARABINERS

PULLEYS

ASCENDERS

DESCENDERS

HELMETS

MOBILE FALL ARRESTERS

RETRACTABLE FALL ARRESTERS

RESCUE DEVICES

STRETCHERS

ROPES

BAGS AND ACCESSORIES

SAFETY NETS

EDGE PROTECTION

TRIPOD AND CANTILEVER ARMS

ANCHORAGES

HORIZONTAL LIFELINE

VERTICAL LIFELINE

DEFENCE

LIFTING EQUIPMENT

EXAMPLE OF PRODUCT CODING



E-1 T SERIES

SINGLE – LEG SHOCK ABSORBING TWISTED ROPE LANYARDS

- Made of high tenacity 3 strands twisted rope.
- Allows workers to attach to an anchorage point and remain safe during their work.
- Built-in energy absorber limits the fall arrest force in a fall situation by tearing specific seams.
- Zippered fabric case protects the energy absorber from abrasion and other damages while allowing for regular inspection of the absorber.

Models

- **E-1 T** Shock absorber and lanyard only.
- **E-1 T K-6A/K-6A** Both end with **K-6A** type carabiner.
- **E-1 T K-4A/K-6A** Bottom : **K-6A** type carabiner.
Top : **K-4A** type carabiner.

Length : 1, 2 & 2 meter

Standard: EN 354, EN 355, EN 362, EN 12275

CARABINER OPTIONS

For more information please refer to carabiners section.

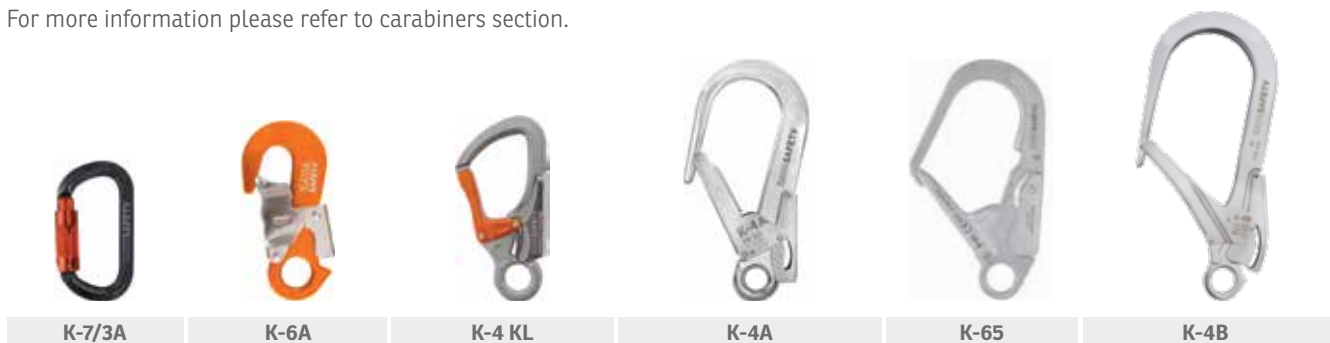

TWIN – LEG SHOCK ABSORBING TWISTED ROPE LANYARDS



E-3 T SERIES

TWIN – LEG SHOCK ABSORBING TWISTED ROPE LANYARD

- Made of high tenacity 3 strands twisted rope.
- Twin-leg model allows user to keep one leg attached to the anchorage while the other leg is always ready to be hooked to the next anchorage.
- Built-in energy absorber limits the fall arrest force in a fall situation by tearing specific seams.
- Zippered fabric case protects the energy absorber from abrasion and other damages while allowing for regular inspection of the absorber.

Models

- **E-3 T** Shock absorber and lanyard only.
- **E-3 T K-4A/K-6A** Bottom : **K-6A** type carabiner.
Top : **K-4A** type carabiner.
- **E-3 T K-6A/K-6A** Both end with **K-6A** type carabiner.

Length : 1, 2 & 2 meter

Standard: EN 354, EN 355, EN 362, EN 12275

CARABINER OPTIONS

For more information please refer to carabiners section.

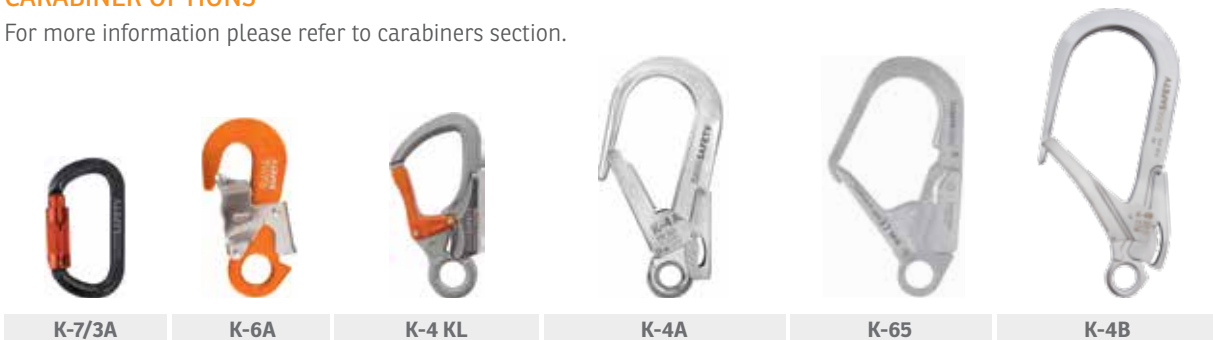

HARNESSES

LANYARDS & SHOCK ABSORBERS

CARABINERS

PULLEYS

ASCENDERS

DESCENDERS

HELMETS

MOBILE FALL ARRESTERS

RETRACTABLE FALL ARRESTERS

RESCUE DEVICES

STRETCHERS

ROPES

BAGS AND ACCESSORIES

SAFETY NETS

EDGE PROTECTION

TRIPOD AND CANTILEVER ARMS

ANCHORAGES

HORIZONTAL LIFELINE

VERTICAL LIFELINE

DEFENCE

LIFTING EQUIPMENT

EXAMPLE OF PRODUCT CODING

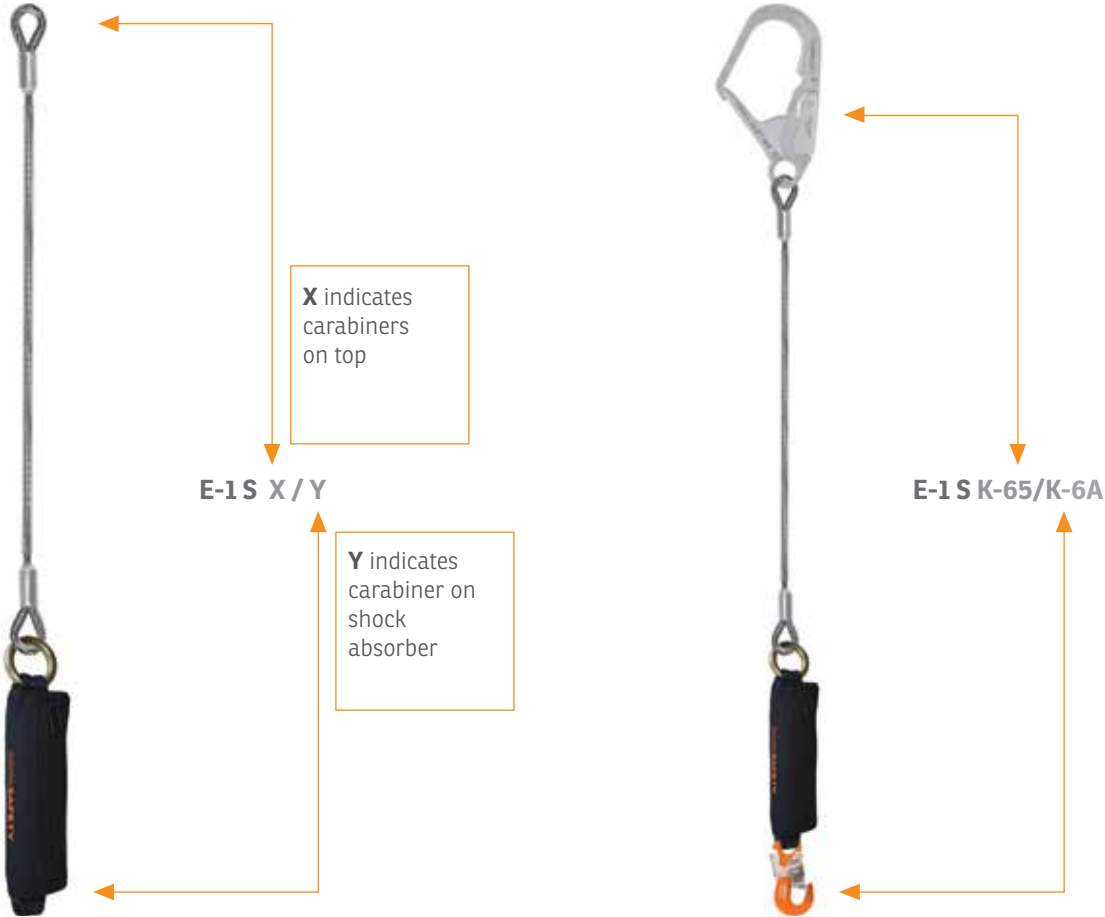

E-1 S SERIES

SINGLE LEG SHOCK ABSORBING WIRE ROPE LANYARD

- PVC coated stainless steel wire rope of dia 8 mm.
- The PVC coating prevents exposure to dirt and chemicals, hence increases corrosion resistance of the lanyard.
- Ideal for cutting trees or welding at height.

Length : 1, 2 & 2 meter

Standard: EN 354, EN 355, EN 362, EN 12275

Models

- **E-1 S K-65/K-6A** Bottom : **K-6A** type carabiner.
Top : **K-65** type carabiner.

CARABINER OPTIONS

For more information please refer to carabiners section.



SINGLE LEG SHOCK ABSORBING WIRE ROPE LANYARDS

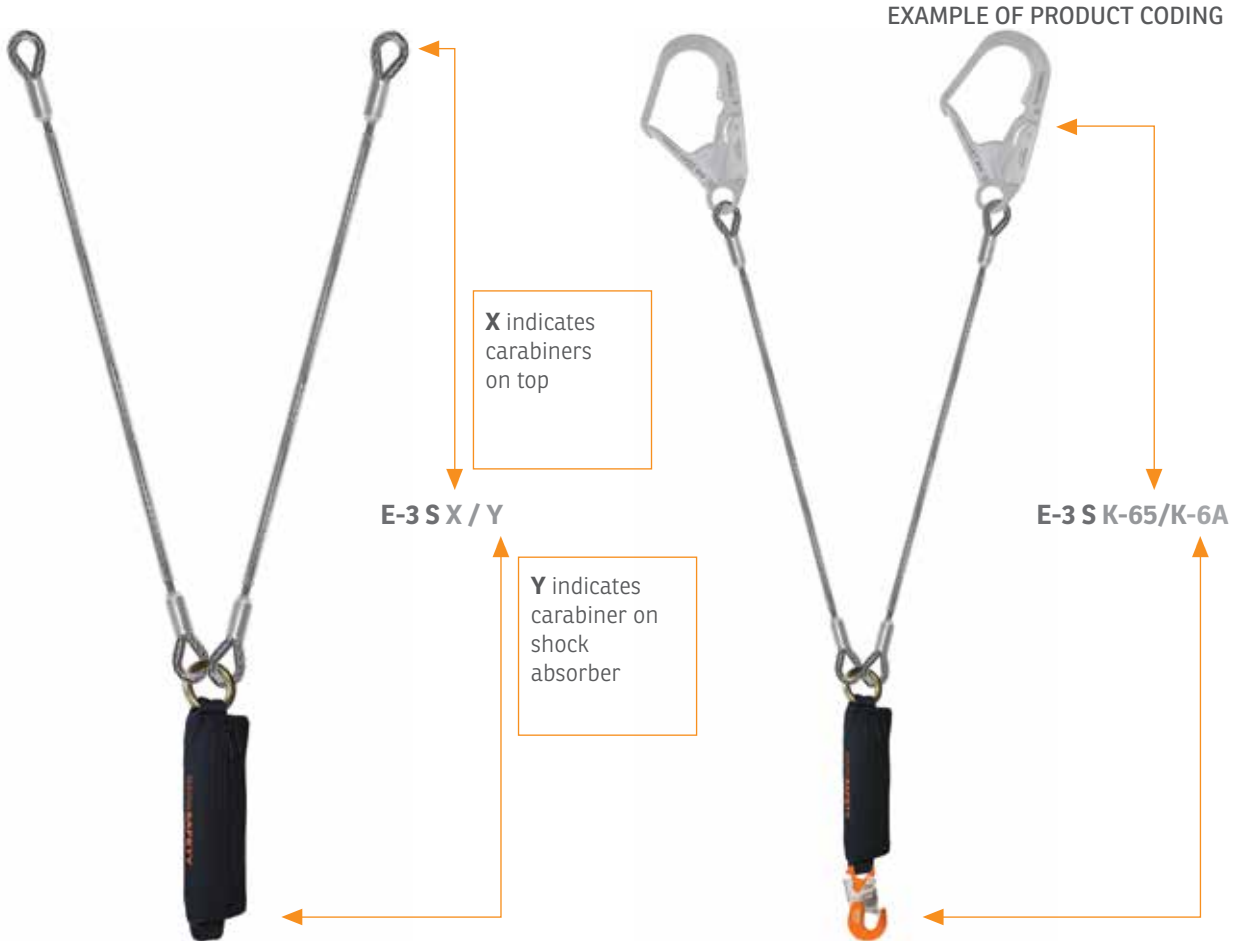

E-3 S SERIES

DOUBLE LEG SHOCK ABSORBING WIRE ROPE LANYARD

- PVC coated stainless steel wire rope of dia 8 mm.
- The PVC coating prevents exposure to dirt and chemicals, hence increases corrosion resistance of the lanyard.
- Ideal for cutting trees or welding at height.
- Twin-leg model allows user to keep one leg attached to the anchorage while the other leg is always ready to be hooked to the next anchorage.

Length : 1, 2 & 2 meter

Standard: EN 354, EN 355, EN 362, EN 12275

Models

- **E-3 S K-65/K-6A** Bottom : **K-6A** type carabiner.
Top : **K-65** type carabiner.

CARABINER OPTIONS

For more information please refer to carabiners section.



HARNESSES

LANYARDS & SHOCK ABSORBERS

CARABINERS

PULLEYS

ASCENDERS

DESCENDERS

HELMETS

MOBILE FALL ARRESTERS

RETRACTABLE FALL ARRESTERS

RESCUE DEVICES

STRETCHERS

ROPES

BAGS AND ACCESSORIES

SAFETY NETS

EDGE PROTECTION

TRIPOD AND CANTILEVER ARMS

ANCHORAGES

HORIZONTAL LIFELINE

VERTICAL LIFELINE

DEFENCE

LIFTING EQUIPMENT

WPL PRODUCT FEATURES

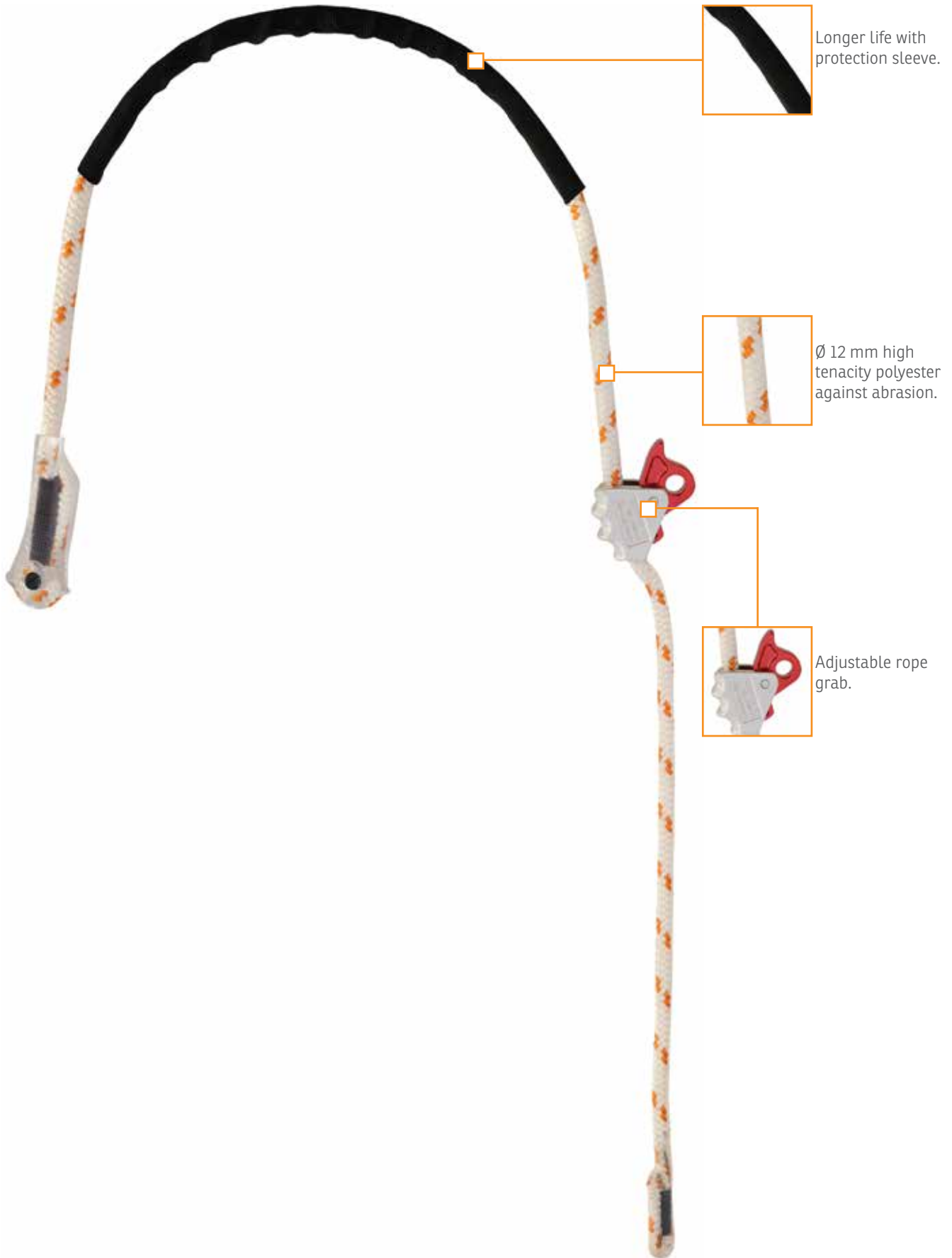

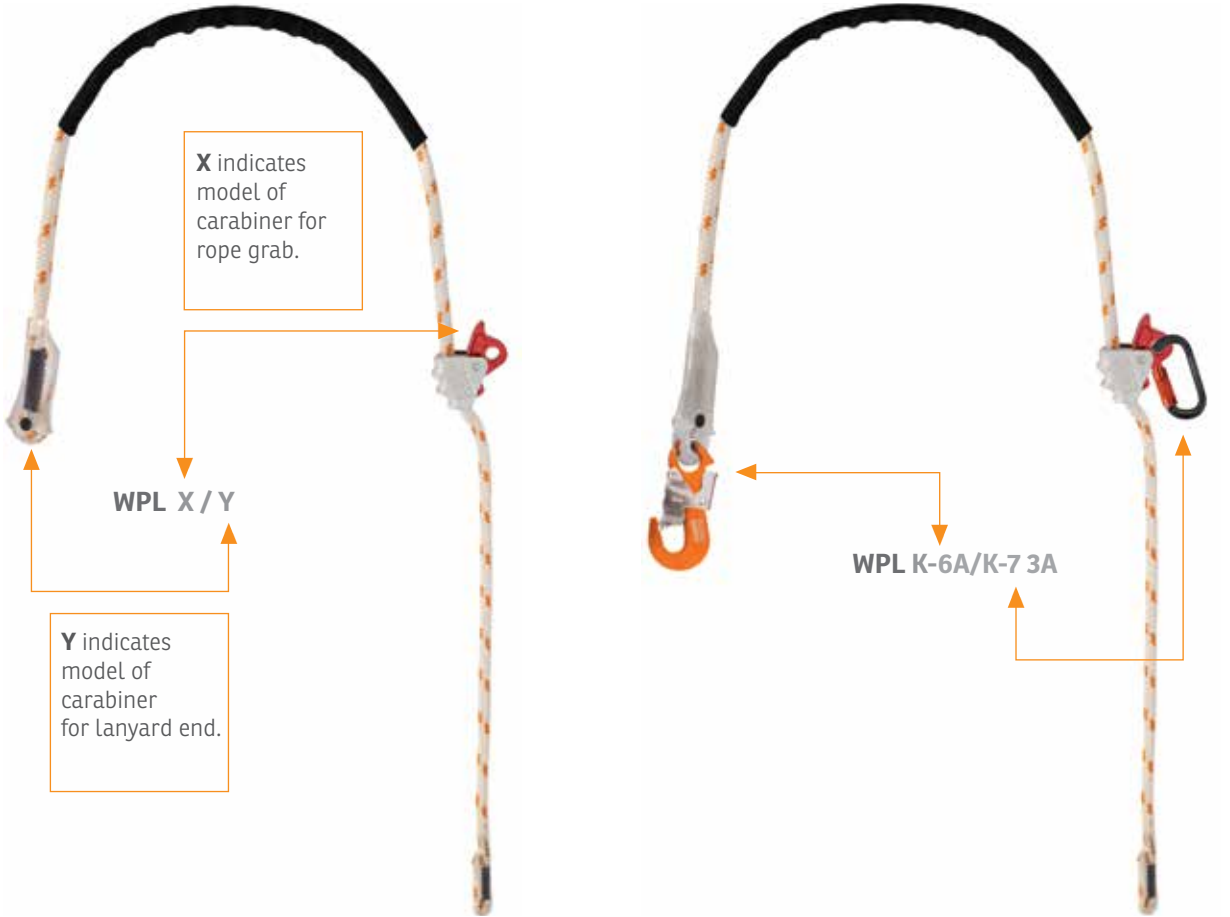

WPL
WORK POSITIONING LANYARD

- Ergonomic design makes it easy to use, ensuring adjustment is quick, accurate and flexible for greater comfort while working.
- Protection sleeve protects the rope against abrasion on rough surfaces and edges.
- Diameter of the rope is 14 mm.
- Rope grab is made of aluminum alloy.
- Stitched in professional CNC machines by bonded type UV and dust resistant high tenacity yarn.

- **WPL** One side with thimble, the other side spliced end.
 - **WPL K-6A/K-7 3A** Rope end : **K-6A** type carabiner. Rope Grab: **K-7/3A** type carabiner.
 - **WPL K-4A/K-7 3A** Rope end : **K-4A** type carabiner. Rope Grab: **K-7/3A** type carabiner.
- Length** : 3 m – 5 m – 7 m – 10 m
Weight : 735 gr
Standard : EN 358, EN 353-2

CARABINER OPTIONS

For more information please refer to carabiners section.

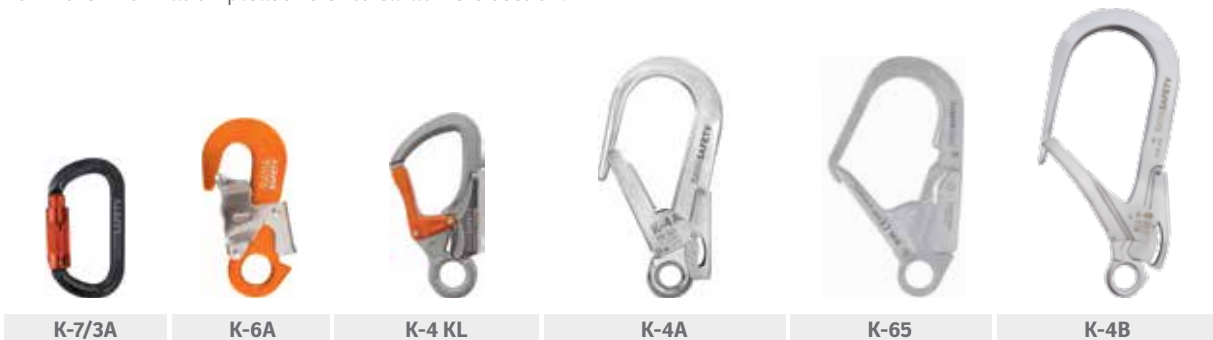

HARNESSES

LANYARDS & SHOCK ABSORBERS

CARABINERS

PULLEYS

ASCENDERS

DESCENDERS

HELMETS

MOBILE FALL ARRESTERS

RETRACTABLE FALL ARRESTERS

RESCUE DEVICES

STRETCHERS

ROPES

BAGS AND ACCESSORIES

SAFETY NETS

EDGE PROTECTION

TRIPOD AND CANTILEVER ARMS

ANCHORAGES

HORIZONTAL LIFELINE

VERTICAL LIFELINE

DEFENCE

LIFTING EQUIPMENT



**BP-50
POSITIONING LOCK**

- Used with WPL work positioning lanyard to lock on poles.

Weight: 177 gr



**WPL WA K-6A
WORK POSITIONING LANYARD**

- Designed for wood or concrete poles.
- Ergonomic design makes it easy to use, ensuring adjustment is quick, accurate and flexible for greater comfort while working.
- Protection sleeve protects the rope against abrasion on rough surfaces and edges.
- Diameter of the rope is 14 mm.
- Rope grab is made of aluminum alloy.
- Stitched in professional CNC machines by bonded type UV and dust resistant high tenacity yarn.

Length : 3 m – 5 m – 7 m – 10 m

Weight : 875 gr

Standard: EN 358, EN 353-2



**RAD
WORK POSITIONING LANYARD**

- The RAD (Rope Adjustment Device) is a multi-functional device which can be used as part of a work-positioning lanyard.
- The RAD can also be used for ascent, descent and work positioning/restraint, belay and progress capture.
- The 'squeeze style' device makes smooth adjustment easy and the spring-loaded flip down handle allows easy use, especially in descent mode.

Length: 3 m – 5 m – 7 m – 10 m

Rope Dia: 10,5 – 12,7 mm

Working Load (WLL): 200 kg

Weight: 306 gr (standard). Subject to change depending on the length of the rope and type of the carabiner.

Standard: CE EN 12841, EN 358, EN15151

CARABINER OPTIONS

For more information please refer to carabiners section.



K-7/3A



K-6A



K-4 KL



K-4A



K-65



K-4B



EXAMPLE OF PRODUCT CODING

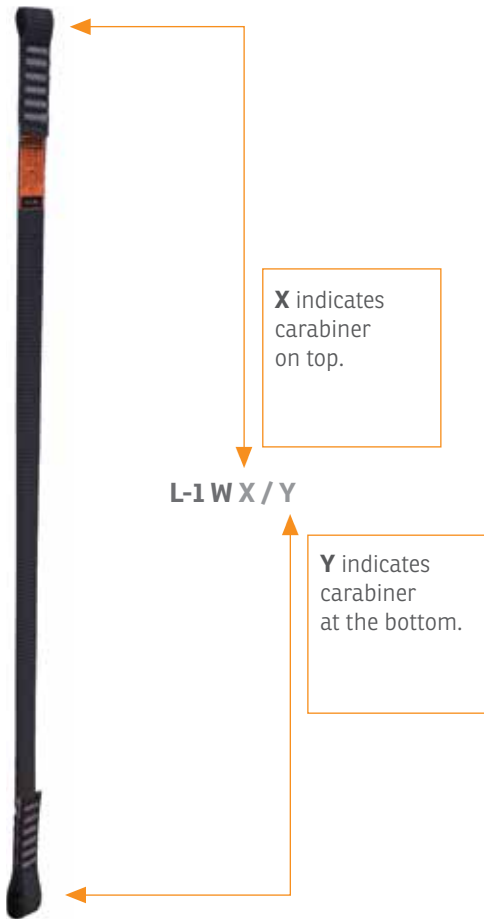

L-1 W SERIES

SINGLE – LEG WEBBING LANYARD

- Allows workers to attach to an anchorage point and remain safe during their work.
- Made of highly resistant polyester webbing.
- Zippered fabric case protects the energy absorber from abrasion and other damages while allowing for regular inspection of the absorber.
- Stitched in professional CNC machines by bonded type UV and dust resistant high tenacity yarn.

Models

- **L-1 W** Shock absorber and lanyard only.
- **L-1 W K-6A/K-6A** Both end with K-6A type carabiner.
- **L-1 W K-4A/K-6A** Bottom: **K-6A** type carabiner.
Top : **K-4A** type carabiner.

Length : 1, 2 & 2 meter

Standard: EN 354, EN 362, EN 12275

CARABINER OPTIONS

For more information please refer to carabiners section.

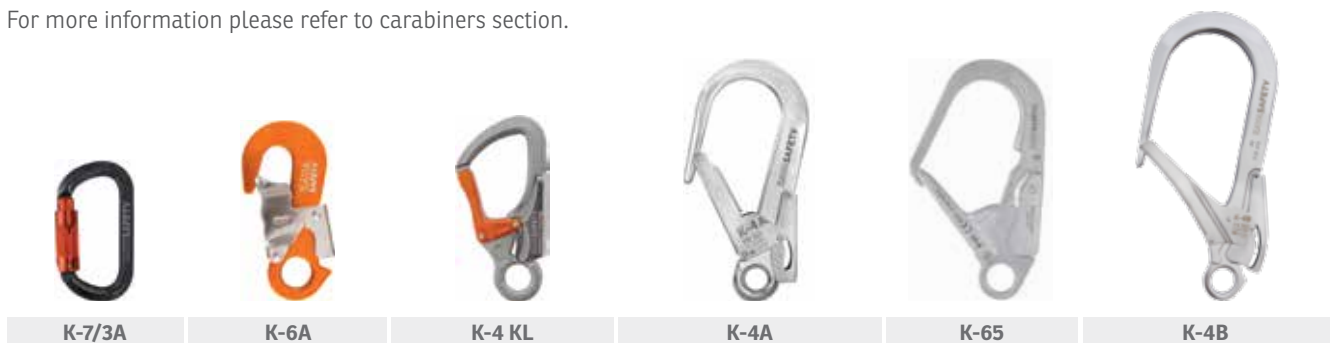

SINGLE – LEG BRAIDED ROPE LANYARDS



L-1 B X / Y

X indicates carabiner on top.

Y indicates carabiner at the bottom.



L-1 B K-4A/K-6A

EXAMPLE OF PRODUCT CODING

L-1 B SERIES

SINGLE – LEG BRAIDED ROPE LANYARD

- Allows workers to attach to an anchorage point and remain safe during their work.
- Made of 12 mm braided rope.
- Zippered fabric case protects the energy absorber from abrasion and other damages while allowing for regular inspection of the absorber.
- Stitched in professional CNC machines by bonded type UV and dust resistant high tenacity yarn.

Models

- **L-1 B** Shock absorber and lanyard only.
- **L-1 B K-6A/K-6A** Both end with **K-6A** type carabiner.
- **L-1 B K-4A/K-6A** Bottom: **K-6A** type carabiner
Top : **K-4A** type carabiner

Length : 1, 2 & 2 meter

Standard: EN 354, EN 362, EN 12275

CARABINER OPTIONS

For more information please refer to carabiners section.



K-7/3A



K-6A



K-4 KL



K-4A



K-65



K-4B

HARNESSES

LANYARDS & SHOCK ABSORBERS

CARABINERS

PULLEYS

ASCENDERS

DESCENDERS

HELMETS

MOBILE FALL ARRESTERS

RETRACTABLE FALL ARRESTERS

RESCUE DEVICES

STRETCHERS

ROPES

BAGS AND ACCESSORIES

SAFETY NETS

EDGE PROTECTION

TRIPOD AND CANTILEVER ARMS

ANCHORAGES

HORIZONTAL LIFELINE

VERTICAL LIFELINE

DEFENCE

LIFTING EQUIPMENT

EXAMPLE OF PRODUCT CODING



L-1 T SERIES

SINGLE – LEG TWISTED ROPE LANYARD

- Made of high tenacity 3 strands twisted rope.
- Allows workers to attach to an anchorage point and remain safe during their work.

Models

- **L-1 T** Shock absorber and lanyard only.
- **L-1 T K-6A/K-6A** Both end with **K-6A** type carabiner.
- **L-1 T K-4A/K-6A** Bottom: **K-6A** type carabiner.
Top : **K-4A** type carabiner.

Length : 1, 2 & 2 meter

Standard: EN 354, EN 362, EN 12275

CARABINER OPTIONS

For more information please refer to carabiners section.

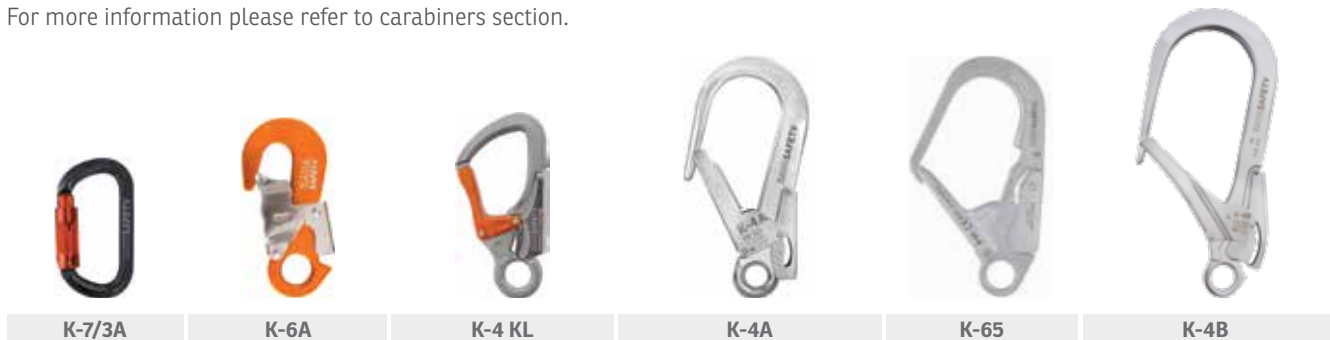



E-7 SHOCK ABSORBER

- Energy absorber limits the fall arrest force in a fall situation by tearing specific seams.
- Zippered fabric case protects the energy absorber from abrasion and other damages while allowing for regular inspection of the absorber.
- Stitched in professional CNC machines by bonded type UV and dust resistant high tenacity yarn.

Length : 30 cm
Length after complete tearing : 1,5 m
Weight : 230 gr
Standard : EN 355



E-7 K-7 3A/K-7 3A SHOCK ABSORBER

- Energy absorber limits the fall arrest force in a fall situation by tearing specific seams.
- Zippered fabric case protects the energy absorber from abrasion and other damages while allowing for regular inspection of the absorber.
- Stitched in professional CNC machines by bonded type UV and dust resistant high tenacity yarn.
- Both end with K-7/3A type carabiner.

Length : 46 cm
Length after complete tearing : 1,7 m
Weight : 522 gr
Standard : EN 355, EN 362, EN 12275



HARNESSES

LANYARDS &
SHOCK ABSORBERS

CARABINERS

PULLEYS

ASCENDERS

DESCENDERS

HELMETS

MOBILE FALL
ARRESTERS

RETRACTABLE
FALL ARRESTERS

RESCUE DEVICES

STRETCHERS

ROPES

BAGS AND
ACCESSORIES

SAFETY NETS

EDGE PROTECTION

TRIPOD AND
CANTILEVER ARMS

ANCHORAGES

HORIZONTAL
LIFELINE

VERTICAL LIFELINE

DEFENCE

LIFTING
EQUIPMENT





K-2 K-2/3ACP



K-30/SL K-30/3A



K-25/3A



K-14/SL K-14/3A

STEEL CARABINERS

Oval-shaped carabiners are designed to be used as anchorage connectors for fall arrest, restraint, work positioning, suspension or rescue systems.



K-7/SL K-7/3A



K-9/SL K-9/3A



K-13/SL K-13/3A

ALUMINUM CARABINERS

Aluminum carabiners are designed to be used as connector in safety equipment. Perfect choice for all light-duty applications and for personal use.



K-4A K-65 K-4B

WIDE-MOUTHED CARABINERS

Designed for connecting to metallic structural members of large size, as well as large diameter cables and bars.



K-6 K-6 A K-4 KL K-4 SW

DOUBLE SAFETY CARABINERS

Designed for lanyards which are attached to harnesses.



K-8

SPECIAL CARABINERS

Designed to be used for special purposes.



K-20 K-21

QUICKLINK CARABINERS



K-12 K-12 F K-12 E 12 CM K-12 E 17 CM

MOUNTAINEER CARABINERS

HARNESSES

LANYARDS & SHOCK ABSORBERS

CARABINERS

PULLEYS

ASCENDERS

DESCENDERS

HELMETS

MOBILE FALL ARRESTERS

RETRACTABLE FALL ARRESTERS

RESCUE DEVICES

STRETCHERS

ROPES

BAGS AND ACCESSORIES

SAFETY NETS

EDGE PROTECTION

TRIPOD AND CANTILEVER ARMS

ANCHORAGES

HORIZONTAL LIFELINE

VERTICAL LIFELINE

DEFENCE

LIFTING EQUIPMENT



K-30/SL



K-2



K-30/3A



K-14/SL



K-2/3ACP



K-25/3A



K-14/3A

K-2 SERIES

OVAL-SHAPED STEEL CARABINER

- Designed for difficult working environments.
- Multi-purpose use.

Strength : 28 kN (K-2)
25 kN (K-2/3ACP)

Gate Opening: 18 mm (K-2)
16 mm (K-2/3ACP)

Weight : 161 gr (K-2)
187 gr (K-2/3ACP)

Standard : EN 362, EN 12275, UIAA

Models

- **K-2** Screw Locking.
- **K-2/3ACP** Triple action - auto locking.

K-30 SERIES

OVAL-SHAPED STEEL CARABINER

- Designed for difficult working environments.
- Multi-purpose use.
- Keylock system helps prevent snagging of the carabiner during maneuvers.
- Red indicator provides a visual warning when the carabiner is unlocked. (on SCREW-LOCK version)

Strength : 30 kN (K-30 SL, K-30/3A)
25 kN (K-25/3A)

Gate Opening: 17 mm

Weight : 179 gr (K-30 SL)
198 gr (K-30/3A)

198 gr (K-25/3A)

Standard : EN 362, EN 12275

Models

- **K-30/SL** Screw Locking.
- **K-30/3A** Double action - auto locking.
- **K-25/3A** Triple action - auto locking. (Stainless Steel)

K-14 SERIES

LARGE GATE OPENING STEEL CARABINER

- Designed for difficult working environments
- Large size and opening to allow easy anchoring of several ropes and slings
- Keylock system helps prevent snagging of the carabiner during maneuvers.
- Red indicator provides a visual warning when the carabiner is unlocked. (on SCREW-LOCK version)

Strength : 50 kN

Gate Opening: 22 mm

Weight : 210 gr (K-14/SL)
216 gr (K-14/2A)

218 gr (K-14/3A)

Standard : EN 362

Models

- **K-14/SL** Screw Locking.
- **K-14/3A** Triple action - auto locking.



K-7/S�



K-9/S�



K-13/S�



K-7/3A



K-9/3A



K-13/3A

K-7 SERIES

OVAL - SHAPED
ALUMINUM CARABINER

- Multi-purpose use.
- Keylock system prevents snagging of the carabiner during maneuvers.
- Red indicator provides a visual warning when the carabiner is unlocked (on SCREW-LOCK version).

Strength : 23 kN
Gate Opening: 19 mm
Weight : 75 gr (K-7/S�)
 79 gr (K-7/2A)
 81 gr (K-7/3A)
Standard : EN 362, EN 12275

Models

- **K-7/S�** Screw Locking.
- **K-7/3A** Triple action - auto locking.

K-9 SERIES

LARGE GATE OPENING
ALUMINUM CARABINER

- Large size and opening to allow easy anchoring of several ropes and slings.
- Keylock system prevents snagging of the carabiner during maneuvers.
- Red indicator provides a visual warning when the carabiner is unlocked (on SCREW-LOCK version).

Strength : 24 kN
Gate Opening: 23 mm
Weight : 86 gr (K-9/S�)
 94 gr (K-9/2A)
 95 gr (K-9/3A)
Standard : EN 362, EN 12275

Models

- **K-9/S�** Screw Locking.
- **K-9/3A** Triple action - auto locking.

K-13 SERIES

ASYMMETRICAL
ALUMINUM CARABINER

- Specially adapted for attaching equipment.
- Excellent strength-to-weight ratio.
- Keylock system prevents snagging of the carabiner during maneuvers.
- Red indicator provides a visual warning when the carabiner is unlocked (on SCREW-LOCK version).

Strength : 22 kN
Gate Opening: 21 mm
Weight : 82 gr (K-13/S�)
 86 gr (K-13/2A)
 87 gr (K-13/3A)
Standard : EN 362, EN 12275

Models

- **K-13/S�** Screw Locking.
- **K-13/3A** Triple action - auto locking.

HARNESSES

LANYARDS &
SHOCK ABSORBERS

CARABINERS

PULLEYS

ASCENDERS

DESCENDERS

HELMETS

MOBILE FALL
ARRESTERS

RETRACTABLE
FALL ARRESTERS

RESCUE DEVICES

STRETCHERS

ROPES

BAGS AND
ACCESSORIES

SAFETY NETS

EDGE PROTECTION

TRIPOD AND
CANTILEVER ARMS

ANCHORAGES

HORIZONTAL
LIFELINE

VERTICAL LIFELINE

DEFENCE

LIFTING
EQUIPMENT



K-4



K-4 B



K-65



K-4 A



K-4
**ALUMINUM WIDE-MOUTHED
DOUBLE ACTION CARABINER**

- Large size and wide gate opening facilitate use on large metallic structures.
- Double Locking.

Strength : 20 kN
Gate Opening: 56 mm
Weight : 504 gr
Standard : EN 362

K-65
**WIDE-MOUTHED DOUBLE ACTION
CARABINER**

- Large size and wide gate opening facilitate use on large metallic structures.
- Double Locking.
- Made of steel.

Strength : 23 kN
Gate Opening: 65 mm
Weight : 635 gr
Standard : EN 362

K-4 SERIES
**ALUMINUM WIDE-MOUTHED
DOUBLE ACTION CARABINER**

- Large size and wide gate opening facilitate use on large metallic structures.
- Double Locking.

Models
• **K-4 B** (Gate opening 110 mm)
• **K-4 A** (Gate opening 63 mm)

Strength : 22 kN
Gate Opening: 63 mm (K-4A),
110 mm (K-4B)
Weight : 490 gr (K-4A),
900 gr (K-4B)
Standard : EN 362

F-4 SERIES
**SPECIAL ANCHORAGE
CARABINER**

- Ideal for creating safe anchorage point.

Models
• **F-4**
• **F-4 A**

Material : Stainless Steel
Gate Opening: 105 mm (F-4),
140 mm (F-4 A)
Strength : 23 kN
Weight : 346 gr



K-6



K-6 A

K-6 SERIES DOUBLE SAFETY CARABINER

- Strength** : 25 kN
- Gate Opening:** 18 mm (K-6),
20 mm (K-6 A)
- Material** : Zinc-plated steel
- Weight** : 245 gr (K-6),
152 gr (K-6A)
- Standard** : EN 362

Models

- **K-6** (Steel, Gate Opening 18 mm)
- **K-6A** (Aluminum, Gate Opening 20 mm)



K-4 KL



K-4 SW

K-4 KL DOUBLE SAFETY ALUMINUM CARABINER

- Strength** : 30 kN
- Gate Opening:** 25 mm
- Material** : Aluminum
- Weight** : 127 gr
- Standard** : EN 362

K-4 SW SWIVEL CAPTIVE EYE ALUMINUM CARABINER

- Double Safety.

- Strength** : 28 kN
- Gate Opening:** 25 mm
- Material** : Aluminum
- Weight** : 183 gr
- Standard** : EN 362



K-8 LARGE GATE ALUMINUM CARABINER

- Large size and opening to allow easy anchoring of several ropes and slings.
- Keylock system prevents snagging of the carabiner during maneuvers.
- Mostly preferred by Firefighters, Search and Rescue Team, Civil Defense, Medical Rescue.

- Strength** : 22 kN
- Gate Opening:** 42 mm
- Weight** : 87 gr
- Standard** : EN 362, EN 12275,
UIAA

HARNESSES

LANYARDS &
SHOCK ABSORBERS

CARABINERS

PULLEYS

ASCENDERS

DESCENDERS

HELMETS

MOBILE FALL
ARRESTERS

RETRACTABLE
FALL ARRESTERS

RESCUE DEVICES

STRETCHERS

ROPES

BAGS AND
ACCESSORIES

SAFETY NETS

EDGE PROTECTION

TRIPOD AND
CANTILEVER ARMS

ANCHORAGES

HORIZONTAL
LIFELINE

VERTICAL LIFELINE

DEFENCE

LIFTING
EQUIPMENT



K-20



K-12



K-21



K-12 F



K-12 E 12 CM



K-12 E 17 CM

K-20
OVAL-SHAPED STEEL QUICKLINK

- Screw Locking.

Strength : 30 kN
Weight : 73 gr
Standard : EN 362, EN 12275

K-21
TRIANGLE-SHAPED STEEL QUICKLINK

- Screw Locking.

Strength : 25 kN
Weight : 87 gr
Standard : EN 362, EN 12275

K-12 SERIES
ALUMINUM MOUNTAINEER CARABINERS

- Used for outdoor climbing.
- Keylock system prevents snagging of the carabiner during maneuvers.
- H-shaped cross section offers an improved strength/weight ratio.

Strength : 26 kN
Gate Opening: 25 mm (K-12),
21 mm (K-12 F)
Weight : 51 gr
Standard : EN 362, EN 12275 UIAA

- Models**
- **K-12** (Bent-Gate, Gate Opening 25 mm)
 - **K-12 F** (Straight-Gate, Gate Opening 21 mm)

K-12 E
QUICK DRAW CARABINER

- Joined by Dyneema dogbone.
- Ideal for climbing.
- Straight-Gate and Bent-Gate carabiner.

Strength : 26 kN
Weight : 115 gr (K-12 E 17 cm)
109 gr (K-12 E 12 cm)
Standard : EN 12275, EN 362, EN 566

- Models**
- **K-12 E** Ekpress Band
 - **K-12 E** Ekpress Band





WRONG



WRONG



CORRECT



WRONG



WRONG



CORRECT



WRONG



WRONG



CORRECT

IMAGE	MATERIAL	TYPE	PRODUCT NAME	LOCKING TYPE	STANDARD	GATE OPENING	STRENGTH			WEIGHT
							VERTICAL AXIS	HORIZONTAL AXIS	WHEN GATE OPENED	
	HIGH TENACITY STEEL	OVAL-SHAPED	K-2	SCREW	EN 362, EN 12275	18 MM	28 KN	12 KN	8 KN	161 GR
			K-2/3ACP	TRIPLE ACTION	EN 362, EN 12275	16 MM	25 KN	16 KN	9 KN	187 GR
			K-30/SL	SCREW	EN 362, EN 12275	17 MM	30 KN	16 KN	8 KN	179 GR
			K-30/3A	TRIPLE ACTION	EN 362, EN 12275	17 MM	30 KN	16 KN	8 KN	198 GR
	STAINLESS STEEL		K-25/3A	TRIPLE ACTION	EN 362, EN 12275	17 MM	25 KN	7 KN	7 KN	198 GR
	CARBON STEEL	PEAR-SHAPED	K-14/SL	SCREW	EN 362, EN 12275	22 MM	50 KN	7 KN	7 KN	210 GR
			K-14/2A	DOUBLE ACTION	EN 362, EN 12275	22 MM	50 KN	7 KN	7 KN	216 GR
			K-14/3A	TRIPLE ACTION	EN 362, EN 12275	21 MM	50 KN	7 KN	7 KN	218 GR
	ALUMINUM	OVAL-SHAPED	K-7/SL	SCREW	EN 362, EN 12275	19 MM	23 KN	7 KN	7 KN	75 GR
			K-7/2A	DOUBLE ACTION	EN 362, EN 12275	19 MM	23 KN	7 KN	7 KN	79 GR
			K-7/3A	TRIPLE ACTION	EN 362, EN 12275	19 MM	23 KN	7 KN	7 KN	81 GR
		PEAR-SHAPED	K-9/SL	SCREW	EN 362, EN 12275	24 MM	24 KN	7 KN	7 KN	86 GR
			K-9/2A	DOUBLE ACTION	EN 362, EN 12275	23 MM	24 KN	7 KN	7 KN	94 GR
			K-9/3A	TRIPLE ACTION	EN 362, EN 12275	23 MM	24 KN	7 KN	7 KN	95 GR
		D-SHAPED	K-13/SL	SCREW	EN 362, EN 12275	21 MM	22 KN	7 KN	7 KN	82 GR
			K-13/2A	DOUBLE ACTION	EN 362, EN 12275	21 MM	22 KN	7 KN	7 KN	86 GR
			K-13/3A	TRIPLE ACTION	EN 362, EN 12275	21 MM	22 KN	7 KN	7 KN	87 GR
		PEAR-SHAPED	K-8	TRIPLE ACTION	EN 362, EN 12275	26 MM	22 KN	10 KN	8 KN	87 GR
			STEEL	WIDE-MOUTHED	K-65	DOUBLE SAFETY	EN 362	65 MM	23 KN	-----
K-4	EN 362				56 MM		20 KN	-----	15 KN	504 GR
ALUMINUM	K-4 A		EN 362		63 MM		22 KN	-----	15 KN	490 GR
	K-4 B		EN 362		110 MM		22 KN	-----	15 KN	900 GR
	STEEL	SMALL-MOUTHED	K-6	DOUBLE SAFETY	EN 362	18 MM	25 KN	-----	-----	245 GR
			K-6 A		EN 362	20 MM	25 KN	-----	-----	152 GR
	ALUMINUM	WIDE-MOUTHED	K-4/KL		EN 362	25 MM	30 KN	-----	-----	127 GR
			K-4/SW		EN 362	25 MM	28 KN	-----	-----	183 GR
	STAINLESS STEEL	OVAL-SHAPED	K-20	QUICKLINK	EN 362, EN 12275	9,5 MM	30 KN	-----	10 KN	73 GR
		DELTA	K-21	QUICKLINK	EN 362, EN 12275	9,5 MM	25 KN	-----	10 KN	87 GR
	ALUMINUM	MOUNTAINEER	K-12	SPRING-LOADED	EN 362, EN 12275	25 MM	26 KN	8 KN	9 KN	51 GR
			K-12 F	SPRING-LOADED	EN 362, EN 12275	21 MM	26 KN	8 KN	9 KN	51 GR





RP-431

RESCUE HAULER PULLEY

The R-ALF Pulley is the latest innovation in Rescue, Confined Space working and Work Suspension Systems. The R-ALF Pulley has an over-speed brake built in so that the Pulley will lock on and hold when a fall occurs.



RP-702



RP-703

CAPTURE PULLEY

One-way locking bearings are ideal for lifting and lowering. The wheel is locked in one direction, to create maximum friction when lowering/releasing. In the opposite direction the wheel runs freely, for minimum friction for lifting/hauling/tensioning.



RP-012



RP-030



P-1



P-3



P-4



P-5

HIGH STRENGTH ALUMINUM PULLEYS

Versatile pulley with high strength designed for a variety of uses. Except P-3, all are suitable for prusik knot.



P-11



P-12



P-13



P-14

STAINLESS STEEL HIGH STRENGTH PULLEYS

Stainless Steel sheaves for excellent durability. Self - Lubricating bushings thanks to the sealed ball bearing system.



HAULERBINER

COMPACT RESCUE KIT

The HaulerBiner Rescue is a compact kit, which can be worn on the harness and used for Pick -off Rescue in work at height and rope access rescues.



P-8 B



RP074



RP-075



RP-076

TANDEM PULLEYS

The design of these mid-sized trolleys uses state of the art engineering techniques to ensure that the Trolley will run and run! The Zipspeed Tandems are fitted with rubber sealed, deep groove bearings for optimal performance and a lifespan of several thousand miles/km. The side plates are made from Aerospace Grade 7075 Aluminium, to minimise flex.

HARNESSES

LANYARDS & SHOCK ABSORBERS

CARABINERS

PULLEYS

ASCENDERS

DESCENDERS

HELMETS

MOBILE FALL ARRESTERS

RETRACTABLE FALL ARRESTERS

RESCUE DEVICES

STRETCHERS

ROPES

BAGS AND ACCESSORIES

SAFETY NETS

EDGE PROTECTION

TRIPOD AND CANTILEVER ARMS

ANCHORAGES

HORIZONTAL LIFELINE

VERTICAL LIFELINE

DEFENCE

LIFTING EQUIPMENT

5:1



RP-431
RESCUE HAULER PULLEY- 2 WAY AUTO LOCKING

- The R-ALF Pulley is the latest innovation in Rescue, Confined Space and Work Suspension Systems.
- The R-ALF Pulley has an over-speed brake built in so that the pulley will lock on and hold when a fall occurs.
- The load rated Becket Eye on the R-ALF means that it can be used in combination with Prussik Pulleys to create a 3 : 1 or 5 : 1 Mechanical Advantage System.
- Minimum annual service intervals apply.

Strength : 40 kN
Body Material : Aluminum
Rope Diameter Range : Approved 11mm EN1891-A Ropes Only.
Weight : 1.200 gr
Standard : EN 12278, ANSI Z359: 4: 2007

HAULERBINER
COMPACT RESCUE KIT

- The HaulerBiner Rescue is a compact kit, which can be worn on the harness and used for Pick-off Rescue in work at height and rope access rescues.
- The HaulerBiner can also be used to easily adjust the orientation of a stretcher and can be used for short - haul tensioning.
- The pulley wheels are mounted in the body of the Karabiner, keeping them clear of the anti -tangle mesh outer, preventing it from jamming the wheels).
- When suspended in a harness, the user can pull up on the system and achieve a 7:1(theoretical) Mechanical Advantage
- The HaulerBiner is supplied in a double pocket pouch, for easy deployment and storage on the user's harness.

Rope Diameter: 6 mm
Number of Persons: 1 kişi
(SWL) Safe Working Load (kg): 140 kg, 308 lbs
(MBS) Minimum Breaking Strength (kN): 16 kN, 359 lbf
Weight: 575 g, 20 oz (depending on kit length)
Standard: EN12278, EN567

- Product Types;**
- HB105A 1,05m HaulerBiner (Compact Rescue Kit) (105cm (3'7"))
 - HB165A 1,65m HaulerBiner (Compact Rescue Kit) (165cm (5'5"))
 - HB300A 3,00m HaulerBiner (Compact Rescue Kit) (300cm (9'10"))



RP-702
SINGLE PROGRESS
CAPTURE PULLEY

- Has a rotary surface on one side while other surface stays constant.
- The RP702 has a Bushed, standard free running wheel (non-locking).

Strength : 20 x 2 = 40 kN
Safe Working Load: 800 kg
Material : Aluminum
Rope Dia : Max. Ø 10-13 mm
Weight : 664 gr
Standard : EN 12278, NFPA 1983



RP-703
DOUBLE PROGRESS
CAPTURE PULLEY

- Has a rotary side plate on one side while other side plate stays constant.
- The RP703 has Bushed, standard free running wheels (non-locking).

Strength : 20 x 2 = 40 kN
Safe Working Load: 800 kg
Material : Aluminum
Rope Dia: Max. Ø 10-13 mm
Weight : 908 gr
Standard : EN 12278, NFPA 1983



RP-012
SMALL SINGLE
PULLEY

- Lightweight, compact pulley.
- Has a rotating side plates.
- Designed for use with a Prusik friction hitch to build a light progress capture system. The shape of the side plates allows the knot to be released when it comes against the pulley.

Strength: 18 x 2 = 36 kN
Material : Aluminum
Rope Dia : Max. Ø 13 mm
Weight : 87 gr
Standard : EN 12278



RP-030
SMALL DOUBLE
PULLEY

- Lightweight eiger pulleys are made from high strength aluminum and fitted with tamper-proof rivets.
- Has a rotating side plates
- Designed for use with a Prusik friction hitch to build a light progress capture system. The shape of the side plates allows the knot to be released when it comes against the pulley.

Strength: 18 x 2 = 36 kN
Material : Aluminum
Rope Dia : Max. Ø 16 mm
Weight : 163 gr
Standard : EN 12278

HARNESSES

LANYARDS &
SHOCK ABSORBERS

CARABINERS

PULLEYS

ASCENDERS

DESCENDERS

HELMETS

MOBILE FALL
ARRESTERS

RETRACTABLE
FALL ARRESTERS

RESCUE DEVICES

STRETCHERS

ROPES

BAGS AND
ACCESSORIES

SAFETY NETS

EDGE PROTECTION

TRIPOD AND
CANTILEVER ARMS

ANCHORAGES

HORIZONTAL
LIFELINE

VERTICAL LIFELINE

DEFENCE

LIFTING
EQUIPMENT



P-1
MOBILE SMALL PULLEY

- Extremely lightweight and ultra-compact pulley.
- Has a rotating side plates.
- Special side plates designed for use with a Prusik friction hitch in progress capture systems.

Strength : 12 x 2 = 24 kN
Malzeme : Aluminum
Material : Max. Ø 11 mm
Rope Dia : 120 gr
Standard: EN 12278



P-3
SINGLE ALUMINUM PULLEY

- Fixed side plates allow quick installation and coupling with a rope clamp.
- Designed for hauling systems and deviations.
- It is necessary to grease and self-service it.

Strength : 10 x 2 = 20 kN
Material : Aluminum
Rope Dia : Max. Ø 13 mm
Weight : 96 gr
Standard : EN 12278



P-4
BIG SINGLE ALUMINUM PULLEY

- Lightweight, high performance pulley adapted for intensive use.
- Has a rotating side plates.
- Special side plates designed for use with a Prusik friction hitch in progress capture systems.

Strength : 15 x 2 = 30 kN
Material : Aluminum
Rope Dia : Max. Ø 16 mm
Weight : 267 gr
Standard : EN 12278



P-5
BIG DOUBLE ALUMINUM PULLEY

- Has a rotating side plates.
- High performance pulley adapted for intensive use.
- Special side plates designed for use with a Prusik friction hitch in progress capture systems.

Strength : 15 x 2 = 30 kN
Material : Aluminum
Rope Dia : Max. Ø 16 mm
Weight : 460 gr
Standard : EN 12278





P-11
SINGLE SHEAVE
STAINLESS STEEL
PULLEY

- Sheave mounted on sealed ball bearings for excellent efficiency.
- Has a rotating side plates.
- Stainless steel sheaves for excellent durability.
- Ideal for hauling up equipment.

Strength : 25 x 2 = 50 kN
Material : 316 SS
Rope Dia : Max. Ø 16 mm
Weight : 540 gr
Standard: EN 12278



P-12
DOUBLE SHEAVE
STAINLESS STEEL
PULLEY

- Sheave mounted on sealed ball bearings for excellent efficiency.
- Has a rotating side plates.
- Ideal for hauling up equipment.

Strength : 25 x 2 = 50 kN
Material : 316 SS
Rope Dia : Max. Ø 16 mm
Weight : 1.092 gr
Standard: EN 12278



P-13
TRIPLE SHEAVE
STAINLESS STEEL
PULLEY

- Sheave mounted on sealed ball bearings for excellent efficiency.
- Has a rotating side plates.
- Ideal for hauling up equipment.

Strength : 25 x 2 = 50 kN
Material : 316 SS
Rope Dia : Max. Ø 16 mm
Weight : 1.785 gr
Standard: EN 12278



P-14
QUAD SHEAVE
STAINLESS STEEL
PULLEY

- Sheave mounted on sealed ball bearings for excellent efficiency.
- Has a rotating side plates.
- Ideal for hauling up equipment.

Strength : 25 x 2 = 50 kN
Material : 316 SS
Rope Dia : Max. Ø 16 mm
Weight : 2.125 gr
Standard: EN 12278



HARNESSES

LANYARDS &
SHOCK ABSORBERS

CARABINERS

PULLEYS

ASCENDERS

DESCENDERS

HELMETS

MOBILE FALL
ARRESTERS

RETRACTABLE
FALL ARRESTERS

RESCUE DEVICES

STRETCHERS

ROPES

BAGS AND
ACCESSORIES

SAFETY NETS

EDGE PROTECTION

TRIPOD AND
CANTILEVER ARMS

ANCHORAGES

HORIZONTAL
LIFELINE

VERTICAL LIFELINE

DEFENCE

LIFTING
EQUIPMENT



P-8 B
TANDEM PULLEY

- Aluminum sheaves mounted on self-lubricating bushings for efficiency.
- Tandem pulleys sheave mounted on sealed ball bearings for excellent efficiency.

Strength : 12 x 2 = 24 kN
Body Material : Aluminum
Pulley Material: Stainless Steel
Rope Dia : Max. Ø 13 mm
Weight : 270 gr
Standard : EN 12278



RP074
ZIPPEY TANDEM PULLEY

- Zippey is manufactured from high-spec 4mm aluminum plate, has a forged aluminum gate and Stainless Steel wheels.
- Compatible with majority of carabiners.
- Zippey is designed to accept a 25mm (1") wide webbing, which can be choke hitched directly into it. The attachment hole has radiuses edges to minimize lanyard wear.
- One handed action with either a single or double locking mechanism for increased safety.

Number of persons : 1 person
Rope Diameter : Max 13 mm
Working Load (MBS) Minimum : 200 kg
Breaking Strength (kN): 25 kN
Weight: : 450 g
Standard : CE EN 12278





RP-075
ZIPLINE TANDEM PULLEY 50mm (2") WHEEL DIAMETER

- The Zipspeed Tandems are fitted with rubber sealed, deep groove bearings for optimal performance and a lifespan of several thousand miles/km.
- The side plates are made from Aerospace Grade 7075 Aluminum, to minimise flex.
- There are extra attachment holes for a secondary lanyard and a small central hole which can be used to fit an accessory.

Strength : 12 x 2 = 24 kN
Pulley Dia : 50 mm
Body Material : Aluminum
Pulley Material: Stainless Steel (316)
Rope Size : Max. Ø 13, 16, 20 mm
Weight : 875 gr
Standard : EN 12278

RP-076
ZIPLINE TANDEM PULLEY 75mm / (3") WHEEL DIAMETER

- The Zipspeed Tandems are fitted with rubber sealed, deep groove bearings for optimal performance and a lifespan of several thousand miles/km.
- The side plates are made from Aerospace Grade 7075 Aluminum, to minimise flex.
- There are extra attachment holes for a secondary lanyard and a small central hole which can be used to fit an accessory.

Strength : 40 kN
Pulley Dia : 75 mm
Body Material : Aluminum
Pulley Material: Stainless Steel (316)
Rope Size : Max. Ø 13, 16, 20 mm
Weight : 1.793 gr
Standard : EN 12278

CODE	TYPE	PIM COLOR	WEIGHT	STRENGTH (MBS)
50 mm PULLEYS				
RP-075A	13 mm	Grey	876 gr	40 kN
RP-075B	16 mm	Orange	874 gr	40 kN
RP-075C	20 mm	Green	875 gr	40 kN
75 mm PULLEYS				
RP-076A	13 mm	Grey	1.796 gr	40 kN
RP-076B	16 mm	Orange	1.794 gr	40 kN
RP-076C	20 mm	Green	1.789 gr	40 kN



HARNESSES

LANYARDS & SHOCK ABSORBERS

CARABINERS

PULLEYS

ASCENDERS

DESCENDERS

HELMETS

MOBILE FALL ARRESTERS

RETRACTABLE FALL ARRESTERS

RESCUE DEVICES

STRETCHERS

ROPES

BAGS AND ACCESSORIES

SAFETY NETS

EDGE PROTECTION

TRIPOD AND CANTILEVER ARMS

ANCHORAGES

HORIZONTAL LIFELINE

VERTICAL LIFELINE

DEFENCE

LIFTING EQUIPMENT



LOKHEAD KIT
LIFTING KIT

LokHead and its accessories fully-boxed in a heavy-duty storage case that allows safe transport and rapid deployment. The kit includes the LokHead, a new robust mounting plate, universal tripod adapter, winch handle, and anchor strop with connectors to offer a variety of mounting options: clamped to tripods, rigged to ropes/strops, or anchored direct to structures. Customers also have the option to purchase the winch and handle and individual accessories/spares separately.

Features

- Designed for confined space retrieval or for use with davit systems using an unlimited length of fibrous rope.
- The captive head allows the winch to be used safely, and keeps the rope from accidentally releasing.
- Rigged to a tripod, it can be used for confined-space rescue, for load moving/hauling, and man-riding.
- Weighing just 4.2 kg (9.3 lb), the LokHead winch can be incorporated into tripod design without significantly increasing the overall weight.
- The braking system controls descent and provides workers protection against free-falls. The encapsulating jaw cover protects fingers and clothing from catching in the winch.
- Easy to rig and efficient, the LokHead makes the most of the operator's strength. The winch offers a 40:1 power ratio with 2 gears: low-load, high line speed; high-load, low line speed
- The winch is designed for use with fiber rope 10 –12.7 mm (5/16 –1/2") in diameter and unlimited line length.
- The winch can be driven manually with the provided 10" B10AL winch handle.

Max Rated Load: 500 kg
Maximum rated load for human suspension: 280 kg
Weight: 4.2 kg
Rope Diameter: 10 – 12.7 mm
Standard: CE EN 13157, EN 1496



















RIGGERS WINCH
PORTABLE WINCH

- The Riggers Winch provides the user with a lightweight, portable winch mounted to a robust adaptor plate.
- Offered in two (2) sizes, the single-speed 200 model weighs only 4 kg (8 lb) and has a maximum rated load of 1.96 kN. The 2-speed 500 model weighs just 7 kg (15.4 lb). Its maximum rated load of 4.90 kN maximizes operator pulling power by up to 40 times.
- Multiple mounting options provide versatility when working in challenging or remote environments.
- The mounting plate is sculpted to remove excess weight and provides multiple attachment points without compromising strength. The pigtail line lead ensures correct alignment and loading of the winch for maximum efficiency.
- The winch is designed for use with fiber rope up to 12 mm (1/2") in diameter, reducing weight and allowing alignment to the load. Smooth surfaces and chafe-free design are amenable to fiber rope.

Working Load (WLL): 500 kg (1102.3 lb)
Break Load : 2500 kg (5511.6 lb)
Weight : 7 kg
Standard : CE (EN 13157)

Simple to use and ideal for diverse applications

- Utility masts
- Telecoms
- Marine
- Wind turbine transition piece davits
- Stage and theater rigging
- Construction
- Confined space
- Access and rescue

IMAGE	PRODUCT CODE	STANDARD	ROPE DIA	BALL BEARING	WORKING STRENGTH	BREAKING STRENGTH	WEIGHT
	RP-431	EN 12841	Ø 11 mm		250 kg	20 kN x 2= 40 kN	1.200 gr
	RP-702	EN 12278 NFPA 1983	Ø 10 mm - 13 mm	NO	4 kN x 2= 8 kN	20 kN x 2= 40 kN	800 gr
	RP-703	EN 12278 NFPA 1983	Max. Ø 16 mm	NO	4 kN x 2= 8 kN	20 kN x 2= 40 kN	908 gr
	RP-012	EN 12278	Max. Ø 13 mm	NO	3 kN x 2 = 6 kN	18 kN x 2 = 36 kN	87 gr
	RP-030	EN 12278	Max. Ø 16 mm	NO	2x3 kN x 2 = 12 kN	18 kN x 2 = 36 kN	163 gr
	P-1	EN 12278	Max. Ø 11 mm	NO	2 kN x 2 = 4 kN	12 kN x 2 = 24 kN	120 gr
	P-3	EN 12278	Max. Ø 13 mm	NO	2 kN x 2 = 4 kN	10 kN x 2 = 20 kN	96 gr
	P-4	EN 12278	Max. Ø 16 mm	NO	3 kN x 2 = 6 kN	10 kN x 2 = 20 kN	267 gr
	P-5	EN 12278	Max. Ø 16 mm	NO	2x3 kN x 2 = 12 kN	15 kN x 2 = 30 kN	460 gr
	P-11	EN 12278	Max. Ø 16 mm	YES	5 kN x 2 = 10 kN	25 kN x 2 = 50 kN	540 gr
	P-12	EN 12278	Max. Ø 16 mm	YES	2x5 kN x 2 = 20 kN	25 kN x 2 = 50 kN	1.092 gr
	P-13	EN 12278	Max. Ø 16 mm	YES	3x5 kN x 2 = 30 kN	25 kN x 2 = 50 kN	1.785 gr
	P-14	EN 12278	Max. Ø 16 mm	YES	4x5 kN x 2 = 40 kN	25 kN x 2 = 50 kN	2.125 gr
	P-8 B	EN 12278	Max. Ø 13 mm	YES	10 kN	12 kN x 2 = 24 kN	270 gr
	RP074	EN 12278	Max. Ø 13 mm	YES	25 kN		450 gr
	RP-075	EN 12278	Ø 13, 16, 20 mm	YES	10 kN	40 kN	875 gr
	RP-076	EN 12278	Ø 13, 16, 20 mm	YES	10 kN	40 kN	1.793 gr





A-1 L A-1 R



RP227 STRYDER



A-2



SE-15



SE-30



SE-1



SE-2

ASCENDERS

Ascenders are used for ascending on a rope. They are very fast and easy to use. Adjustable Foot Loops can be used with handled ascenders or rope grabs to build a rope ascending system.



A-260

CLIMBING IRON

Designed for climbing and working on wooden masts and wooden poles.



DSL-45



FL-500

ROPE LADDERS

HARNESSES

LANYARDS & SHOCK ABSORBERS

CARABINERS

PULLEYS

ASCENDERS

DESCENDERS

HELMETS

MOBILE FALL ARRESTERS

RETRACTABLE FALL ARRESTERS

RESCUE DEVICES

STRETCHERS

ROPES

BAGS AND ACCESSORIES

SAFETY NETS

EDGE PROTECTION

TRIPOD AND CANTILEVER ARMS

ANCHORAGES

HORIZONTAL LIFELINE

VERTICAL LIFELINE

DEFENCE

LIFTING EQUIPMENT



A-1 L A-1 R

A-1 JUMAR

- It is used for ascending on a rope.
- Aluminum alloy material.
- Top captive eyes are to be used with pulleys or rope grabs.
- Lower captive eye is to be used with webbing ladder.
- Outer coating is for comfortable hand grip.

Rope Diameter: Ø 8 -13 mm
Weight : 238 gr
Standard : EN 567, UIAA

Models

- A-1 L** : It is for left hand (Orange)
A-1 R : It is for right hand (Blue)



RP227 STRYDER FOOD ASCENDER

- Designed to provide a smooth upward movement and positive engagement on the rope.
- Adjustable on both the horizontal and vertical straps, allowing the user to position the device on the boot, according to preference.
- The foot-lever can be used to open/close the cam, with the other foot. The foot-lever can also be hooked over the body of the device, to hold the cam in the open (disengaged) position.

Rope Dia : 8 – 13 mm
Minimum Breaking Strength (MBS) : 2,5 kN
Working Load (WLL): 140 kg
Weight : 198 g
Standard : Not for PPE



A-2 CHEST ASCENDER

- Ideal for use in rope access work.
- Compact & lightweight.
- Catch mechanism allows for ease one-handed operation of the device whilst attaching to or removing from the rope.
- Aluminum alloy material.

Rope Diameter: Ø 8 -13 mm
Weight : 159 gr
Standard : EN 567





SE-15

SE-30

SE-15
ADJUSTABLE WEBBING
FOOT LOOP

- Easy to use for ascending.
- High strength of 25 mm polyester webbing.
- Easily adjusted length with QB-25 quick buckles.
- Stitched in professional CNC machines by bonded type UV and dust resistant high tenacity yarn.

Length : 1,5 m
Strength : 23 kN
Weight : 180 gr

SE-30
ADJUSTABLE ETRIER

- Reinforced steps for durability and ease of use when ascending a rope or aid climbing in rope Access.
- High strength of 25 mm polyester webbing.
- Easily adjustable QB-25 quick buckles.
- Stitched in professional CNC machines by bonded type UV and dust resistant high tenacity yarn.
- 3 step with top adjustment.

Length : 1,5 m
Strength : 23 kN
Weight : 185 gr

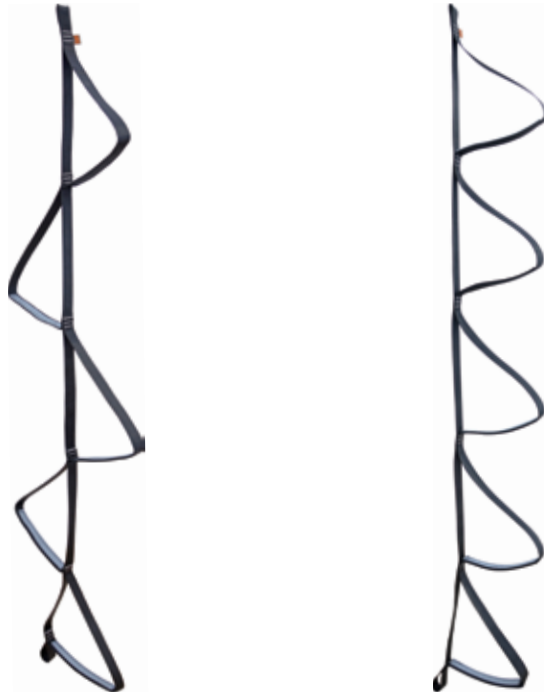

SE-1
ADJUSTABLE 5 STEPS
FOOT LOOP

- Reinforced steps for durability and ease of use when ascending a rope or aid climbing in rope Access.
- High strength of 25 mm polyester webbing.
- Easily adjustable QB-25 quick buckles.
- Stitched in professional CNC machines by bonded type UV and dust resistant high tenacity yarn.
- 5 steps.

Length : 1,5 m
Strength: 23 kN
Weight : 180 gr

SE-2
ADJUSTABLE ETRIER

- Reinforced steps for durability and ease of use when ascending a rope or aid climbing in rope Access.
- High strength of 25 mm polyester webbing.
- Easily adjustable QB-25 quick buckles.
- Stitched in professional CNC machines by bonded type UV and dust resistant high tenacity yarn.
- 5 steps.

Length : 1,5 m
Strength: 23 kN
Weight : 180 gr



HARNESSES

LANYARDS &
SHOCK ABSORBERS

CARABINERS

PULLEYS

ASCENDERS

DESCENDERS

HELMETS

MOBILE FALL
ARRESTERS

RETRACTABLE
FALL ARRESTERS

RESCUE DEVICES

STRETCHERS

ROPES

BAGS AND
ACCESSORIES

SAFETY NETS

EDGE PROTECTION

TRIPOD AND
CANTILEVER ARMS

ANCHORAGES

HORIZONTAL
LIFELINE

VERTICAL LIFELINE

DEFENCE

LIFTING
EQUIPMENT

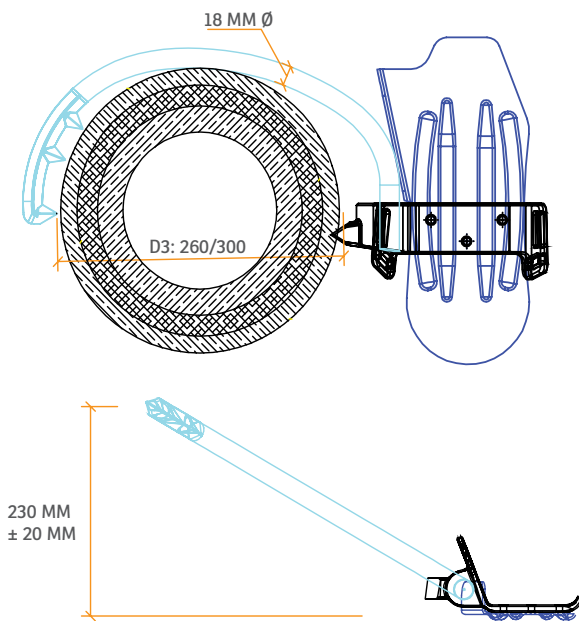
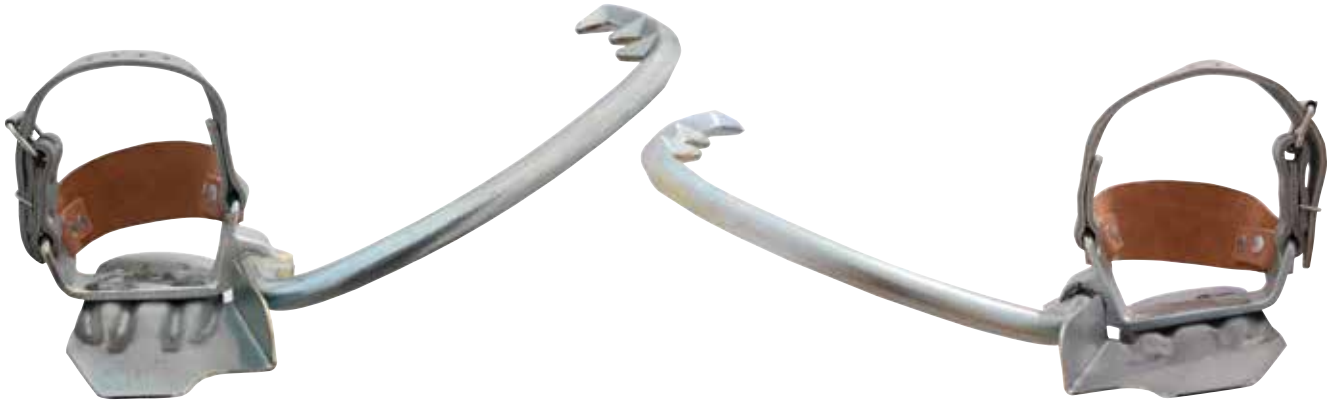

A-260

CLIMBING IRON

- Used for climbing and working on wooden masts and wooden poles.
- Reinforced bow with 3 points for more security and higher loading capacity.
- Bow and foot forged entirely of high quality steel.
- 100% checked for cracking.
- Straps made from anti-bacterial & premium chromium-tanned leather with wide heelpiece.

Material : Forged Steel
Wood Pole Dia: Ø 260-300-320 mm
Weight : 4200 gr
Standard : DIN 48345

Models

A-260: Designed for 260 mm poles.
A-300: Designed for 300 mm poles.

HARNESSES

LANYARDS &
SHOCK ABSORBERS

CARABINERS

PULLEYS

ASCENDERS

DESCENDERS

HELMETS

MOBILE FALL
ARRESTERS

RETRACTABLE
FALL ARRESTERS

RESCUE DEVICES

STRETCHERS

ROPES

BAGS AND
ACCESSORIES

SAFETY NETS

EDGE PROTECTION

TRIPOD AND
CANTILEVER ARMS

ANCHORAGES

HORIZONTAL
LIFELINE

VERTICAL LIFELINE

DEFENCE

LIFTING
EQUIPMENT



DSL-45 DOUBLE STEP WEBBING LADDER

- Made of high strength 45 mm webbing.
- Stitched in professional CNC machines by bonded type UV and dust resistant high tenacity yarn.
- Steps are made of aluminum and spaced in 45 cm increments.

Length: Produced in desired length.

Weight: 850gr/m

Type of carabiner for top anchorage point (sold separately)

- **K-4** double safety carabiner
- **K-2** carabiner
- **K-19** carabiner



FL-500 HEAT AND FLAME RESISTANCE ROPE LADDER

- Made %100 aramid, flame and heat resistance 12 mm rope.
- Steps are made of aluminum and spaced in 40 x 40 cm increments.
- Knotless montage thanks to the 3 pieces of holes on steps.
- Top connection with steel thimbles and K-4 type carabiners.

Length: Produced in desired length.





D-4



D-5



RP-810 AB



RP-400

CONTROLLED DESCENDERS

Controlled descenders are designed for working on rope. By means of anti-panic system, when the user winds up strongly, system is locked automatically.



D-2 A



D-2 B

PERSONAL ESCAPE SYSTEM

This escape system is ideal for fast evacuate in the event of an emergency. Rope used in D-2 A is made of Polyamide & Rope used in D-2 B is made of Technora.



D-8



D-9



D-13

STANDARD DESCENDERS

Simply designed for descending with rope.



POWERSEAT GAS



POWERSEAT COMPACT GAS



POWERSEAT ELECTRIC



POWERSEAT COMPACT ELECTRIC



POWERSEAT BATTERY



POWERSEAT COMPACT BATTERY

POWERSEAT ASCENDING & DESCENDING DEVICE

PowerSeat™ is revolutionary device for working at height. It provides the worker with the ability to ascend quickly, stay in position longer, and work in comfort. The PowerSeat™ provides quality, convenience, safety and the best solution for completing a task on time.

HARNESSES

LANYARDS & SHOCK ABSORBERS

CARABINERS

PULLEYS

ASCENDERS

DESCENDERS

HELMETS

MOBILE FALL ARRESTERS

RETRACTABLE FALL ARRESTERS

RESCUE DEVICES

STRETCHERS

ROPES

BAGS AND ACCESSORIES

SAFETY NETS

EDGE PROTECTION

TRIPOD AND CANTILEVER ARMS

ANCHORAGES

HORIZONTAL LIFELINE

VERTICAL LIFELINE

DEFENCE

LIFTING EQUIPMENT

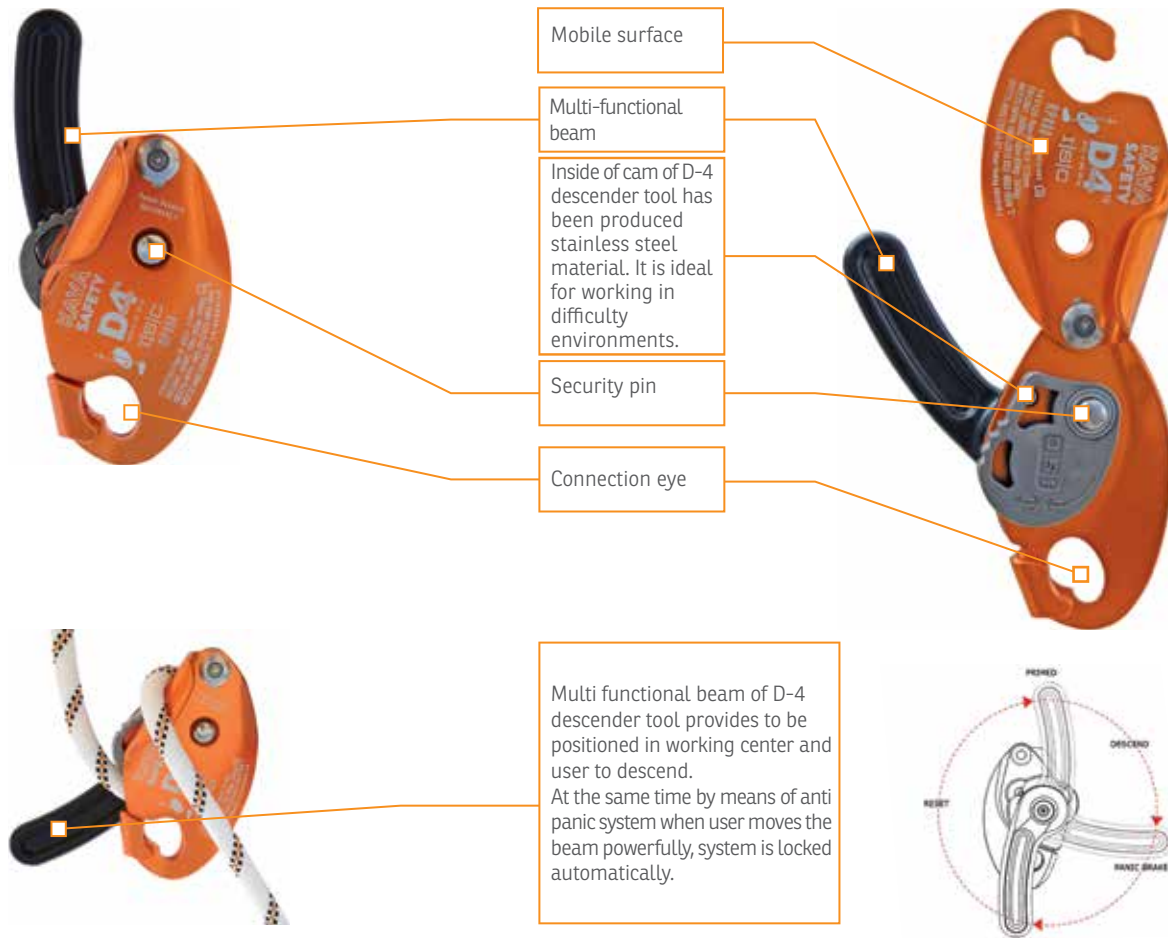

**D-4
DESCENDER (ANTI-PANIC SYSTEM)**

- D4 controlled descender tool is designed for working on rope. D4 enables a unique movement in vertical, horizontal and angled works on rope.
- It will be attached or deductible to system in any point of rope.
- The progressive cam works by way of one cam operating inside another cam.
- In the working with rope, the gap on rope is taken easily.
- It can work by hands free in lock position and can get work position.
- It owns D4 240 kg work weight. Meaning of this is available for rescue work without being required to extra friction.
- The handle mechanism is designed to rotate through 360° making its use easier and simpler. The handle itself is made from aluminum rather than plastic and is coated in a specially chosen paint which provides extra grip.
- The handle rotation is accompanied by audible clicks which help the user identify the correct position of the handle.
- By means of anti-panic system, when the user winds up strongly, system is locked automatically.
- The outer body is made of high strength aluminum material.
- Inner cam is made of stainless steel material.
- Minimum breaking strength is 16 kN.

Rope Dia : Ø 10,5 – 11,5 mm

Weight : 655 gr

Standard : EN 12841, EN 341, ANSI Z359, NFPA 1983



D-2 A ESCAPE DESCENDER (ANTI-PANIC SYSTEM- PES ROPE)

- The D2 is the only micro descender in the world to offer a 'double stop' braking mechanism. The 'double stop' function means that the D2 has a sweet spot in which the descent speed can be easily controlled.
- On either side of the sweet spot is an auto lock function which is activated when a user lets go of the handle it automatically stops the descent and if the user pulls the handle too hard it automatically stops the descent (often known as the panic brake).
- It has a rated load of up to 140kg and a maximum descent capacity of 120m.
- The D2 can be controlled by pushing in the cam which allows the user to smoothly feed the rope through the device, without the use of the handle.
- It is also easy to back feed the rope through the D2 and therefore can be used for smooth ascending or for emergency hauling.
- Standard D2 Escape Kits are supplied with a 15m working lengths.
- Other lengths are available on request.
- Standard polyester ropes are ideal for use in areas such as Linesman Self-rescue from pole tops or for escape from towers or elevating work platforms/ skylifts.

Weight : 1.100 gr
Standard: EN 12841, NFPA

D-2 B ESCAPE DESCENDER (ANTI-PANIC SYSTEM- TECHNORA ROPE)

- The D2 is the only micro descender in the world to offer a 'double stop' braking mechanism. The 'double stop' function means that the D2 has a sweet spot in which the descent speed can be easily controlled.
- On either side of the sweet spot is an auto lock function which is activated when a user lets go of the handle it automatically stops the descent and if the user pulls the handle too hard it automatically stops the descent (often known as the panic brake).
- It has a rated load of up to 140kg and a maximum descent capacity of 120m.
- The D2 can be controlled by pushing in the cam which allows the user to smoothly feed the rope through the device, without the use of the handle.
- It is also easy to back feed the rope through the D2 and therefore can be used for smooth ascending or for emergency hauling.
- Standard D2 Escape Kits are supplied with a 15m working lengths.
- Other lengths are available on request.
- Aramid fibers, (such as Technora) are perfect for use in applications where fire is the main hazard.

Weight : 1.200 gr
Standard: EN 12841, NFPA

HARNESSES

LANYARDS &
SHOCK ABSORBERS

CARABINERS

PULLEYS

ASCENDERS

DESCENDERS

HELMETS

MOBILE FALL
ARRESTERS

RETRACTABLE
FALL ARRESTERS

RESCUE DEVICES

STRETCHERS

ROPES

BAGS AND
ACCESSORIES

SAFETY NETS

EDGE PROTECTION

TRIPOD AND
CANTILEVER ARMS

ANCHORAGES

HORIZONTAL
LIFELINE

VERTICAL LIFELINE

DEFENCE

LIFTING
EQUIPMENT

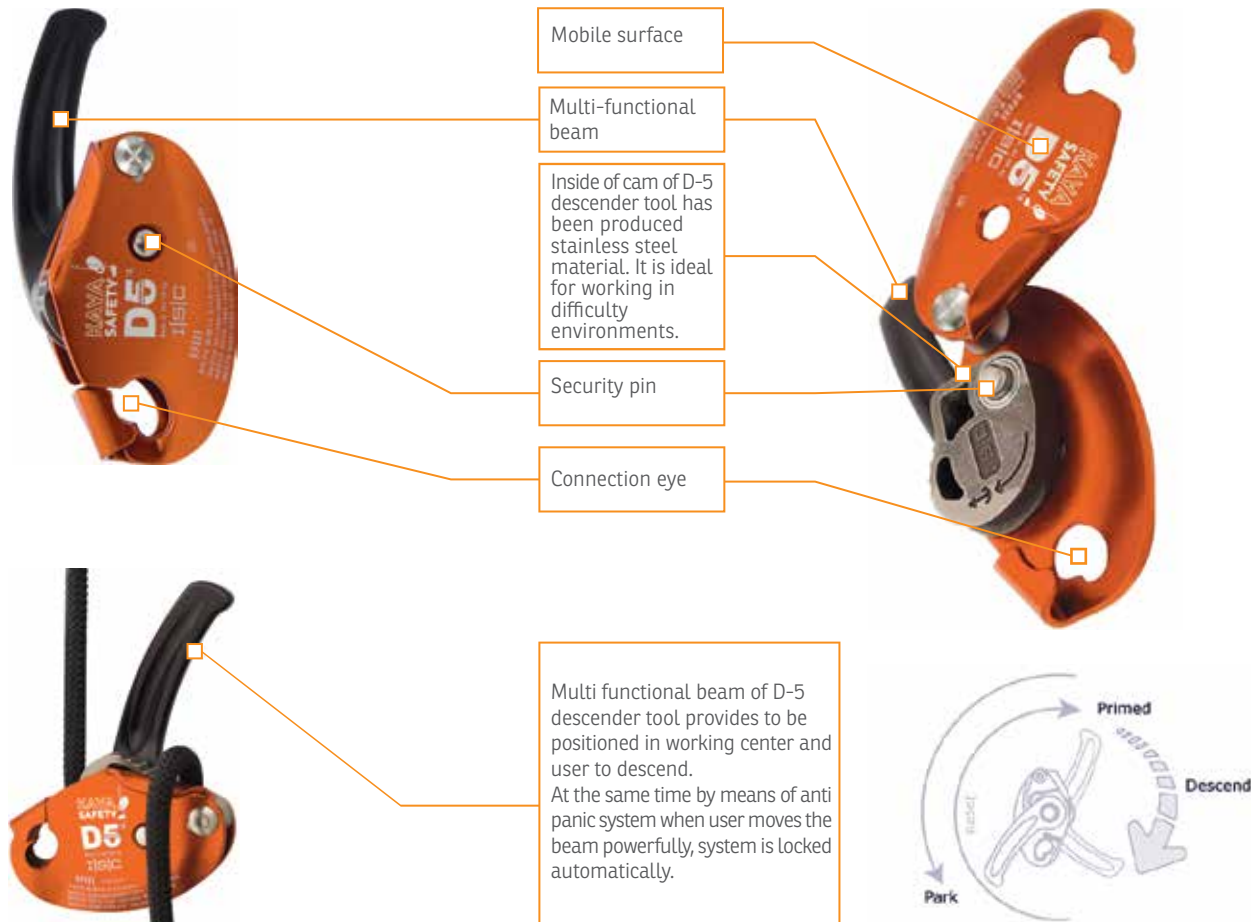

D-5
DESCENDER (ANTI-PANIC SYSTEM)

- The D5 Descender has been designed for use on 1/2" (12.7mm) rope.
- The D5 is a double-stop device with an auto-lock function, which is activated whenever the operator releases the handle; and a panic-brake function, which is not overly sensitive in normal use.
- It also has a double-locking safety mechanism.
- The side plates are designed such that the plates cannot be rotated open, whilst under load, due to the position of the Carabiner.
- The D5 is easy to attach/detach from the rope, without having to detach from the harness, therefore eliminating the risk of accidental dropping of the device.
- The D5 features a progressive cam action, which offers precise control during low or high speeds. The cam is made from high grade, solid Stainless Steel, for maximum durability, even in harsh environments, such as Geotech work.

Rope Dia: Ø 12,7 mm
Weight: 818 gr
(WLL) Working Load Limit (kg): 240
(MBS) Minimum Breaking Strength (kN): 22
Standard: EN 12841:2006/C, NFPA 1983 G, ANSI Z359.4:2013



RP-810 A B
DESCENDER

- Large Top Bobbin- improves rope retention for greater ease of use.
- Extending Handle- for greater control when lowering heavy/two man loads.
- Rope Latch- allows the user to remove the rope, without detaching from their Harness.
- Descender has a panic brake function which is activated when the user pulls too hard on the handle and/or if the user lets go of the handle.

Rope Dia: Ø 10,5 – 12,5 mm

Weight : 436 gr

Standard: EN 12841-B



RP-400
PRO ALLP DESCENDER

- The Pro Allp Descender is a Specialist multi-function device.
- Adjustable, Screw Controlled Descender.
- Auto-lock Controlled Descender (with variable maximum speed setting).
- Can be used for rescue work.
- Breaking strength: 30 kN.
- Made of aluminum alloy material.
- 316 grade stainless steel material.
- Outer frame is made of aluminum material.

Rope Dia: Ø 10,5 – 12,7 mm

Weight : 580 gr

Standard: EN 12841-B



D-9



D-8



D-13

D-8
FIGURE 8

- Ease of use for descending.
- For easy descending on single or double ropes.
- Breaking strength: 35 kN
- Made of aluminum alloy material.
- Rope Dia:** Ø 8 -13 mm
- Weight :** 119 gr
- Standard:** EN 795 Class B, EN 12278

D-9
BENT EAR FIGURE 8

- Has long bent ears to prevent the rope from locking up during descent.
- Breaking strength : 40 kN
- Made of aluminum alloy material.
- Rope Dia:** Ø 8 -13 mm
- Weight :** 270 gr
- Standard:** EN 795 Class B, EN 12278

D-13
BELAY DEVICE

- Used to control a rope during belaying.
- Ultra-compact design is easy to use and doesn't take up much space.
- Act as a friction brake, so that when a climber falls with any slack in the rope, the fall is brought to a stop.
- Breaking strength: 23 kN
- Made of aluminum alloy material.
- Rope Dia:** Ø 8 -13 mm
- Weight :** 270 gr

HARNESSES

LANYARDS & SHOCK ABSORBERS

CARABINERS

PULLEYS

ASCENDERS

DESCENDERS

HELMETS

MOBILE FALL ARRESTERS

RETRACTABLE FALL ARRESTERS

RESCUE DEVICES

STRETCHERS

ROPES

BAGS AND ACCESSORIES

SAFETY NETS

EDGE PROTECTION

TRIPOD AND CANTILEVER ARMS

ANCHORAGES

HORIZONTAL LIFELINE

VERTICAL LIFELINE

DEFENCE

LIFTING EQUIPMENT





POWERSEAT

POWERSEAT GAS



Ergonomic Design

The PowerSeat™ is designed to stay in an upright position, eliminating wasted energy.



Brake

The brake system offers complete security against free fall. The encapsulating jaw cover protects against snagging fingers and clothing in the winch.



Speed control

The unit is operated using a fail-safe dead man's switch to control ascent speed, up to 15 m/min.



Durability and credibility

Stainless steel load-carrying gears and pins provide strength and durability. Sealed gearbox and high-load ball bearings reduce friction under load, are corrosion resistant, and do not require lubrication.



CE Certification

The Harken PowerSeat gas version is CE certified and complies with the essential requirements defined by the Machinery Directive and independently verified by Bureau Veritas.

POWERSEAT COMPACT GAS



Technical Info

Max working load : 273 kg (601.9 lb)

Max ascent speed : 15 m/min (49.2 ft/min)

Weight : 14 kg (30.9 lb)

HARNESSES

LANYARDS & SHOCK ABSORBERS

CARABINERS

PULLEYS

ASCENDERS

DESCENDERS

HELMETS

MOBILE FALL ARRESTERS

RETRACTABLE FALL ARRESTERS

RESCUE DEVICES

STRETCHERS

ROPES

BAGS AND ACCESSORIES

SAFETY NETS

EDGE PROTECTION

TRIPOD AND CANTILEVER ARMS

ANCHORAGES

HORIZONTAL LIFELINE

VERTICAL LIFELINE

DEFENCE

LIFTING EQUIPMENT



POWERSEAT ELECTRIC



Ergonomic Design

The PowerSeat™ is designed to stay in an upright position, eliminating wasted energy.



Brake

The brake system offers complete security against free fall. The encapsulating jaw cover protects against snagging fingers and clothing in the winch.



Speed control

The unit is operated using a fail-safe dead man's switch to control ascent speed, up to 15 m/min.



Durability and credibility

Stainless steel load-carrying gears and pins provide strength and durability. Sealed gearbox and high-load ball bearings reduce friction under load, are corrosion resistant, and do not require lubrication.



CE Certification

The Harken PowerSeat gas version is CE certified and complies with the essential requirements defined by the Machinery Directive and independently verified by Bureau Veritas.

POWERSEAT COMPACT ELECTRIC



Technical Info

Max working load: 300 kg (661.4 lb)
Max ascent speed: 14 m/min (45.9 ft/min) with 125 kg
Weight : 29 kg (44.1 lb)
Cable Length : 35 m



POWERSEAT BATTERY



Speed control
The unit is operated using a fail-safe dead man's switch to control ascent speed, up to 14 m/min(45.9 ft/min).



Ergonomic Design
The PowerSeat™ is designed to stay in an upright position, eliminating wasted energy.



Durability
Stainless steel load-carrying gears and pins provide strength and durability. Sealed gearbox and high-load ball bearings reduce friction under load, are corrosion resistant, and do not require lubrication.



Battery
PowerSeat BATTERY has a 48V lithium-ion battery with a BMS (Battery Management System) to preserve its useful life. Certified IP54.



Brake
The brake system offers complete security against free fall. The encapsulating jaw cover protects against snagging fingers and clothing in the winch.



CE Certification
The Harken PowerSeat battery version is CE certified and complies with the essential requirements defined by the 2006/42/CE Machinery Directive, 2004/108/CE Electromagnetic Compatibility Directive (and independently verified by Bureau Veritas).

POWERSEAT COMPACT BATTERY



Technical Info
Max working load : 300 kg (661.4 lb)
Max ascent speed : At 125 kg 14 m/min
Weight : 19 kg + 3,6 kg
Battery Life : At 125 kg 550 m

HARNESSES

LANYARDS & SHOCK ABSORBERS

CARABINERS

PULLEYS

ASCENDERS

DESCENDERS

HELMETS

MOBILE FALL ARRESTERS

RETRACTABLE FALL ARRESTERS

RESCUE DEVICES

STRETCHERS

ROPES

BAGS AND ACCESSORIES

SAFETY NETS

EDGE PROTECTION

TRIPOD AND CANTILEVER ARMS

ANCHORAGES

HORIZONTAL LIFELINE

VERTICAL LIFELINE

DEFENCE

LIFTING EQUIPMENT





COLORS



DYNAMO 397 INDUSTRIAL HELMET

- Ideal for rescue operation and works at height.
- Quick release buckle.
- Adjustable and removable chinstrap.
- Removable and washable headband.
- Slots for ear protectors (quick fixing/release system).
- Rear adjustable size system.
- Headlamp clips.

- + Lateral deformation
- + Low temperatures -40°
- + Molten steel

Accessories

- Short visor
- Long visor

ACCESSORIES



HARNESSES

LANYARDS & SHOCK ABSORBERS

CARABINERS

PULLEYS

ASCENDERS

DESCENDERS

HELMETS

MOBILE FALL ARRESTERS

RETRACTABLE FALL ARRESTERS

RESCUE DEVICES

STRETCHERS

ROPES

BAGS AND ACCESSORIES

SAFETY NETS

EDGE PROTECTION

TRIPOD AND CANTILEVER ARMS

ANCHORAGES

HORIZONTAL LIFELINE

VERTICAL LIFELINE

DEFENCE

LIFTING EQUIPMENT



COLORS



DYNAMO VOLT
INDUSTRIAL HELMET

- Ideal for rescue operation and works at height.
- Quick release buckle.
- Adjustable and removable chinstrap.
- Removable and washable headband.
- Slots for ear protectors (quick fixing/release system).
- Rear adjustable size system.
- Headlamp clips.

- + Lateral deformation
- + Low temperatures -40°
- + Molten steel

Accessories

- Short visor
- Long visor

- Color** : Red, White, Blue, Orange, Yellow, Green, Black
- Size** : 55/63 cm (Adjustable)
- Weight** : 390 gr
- Outer shell:** Thermo ABS
- Inner shell** : High Tenacity polystyrene EPS foam
- Standard** : EN 397:2012, EN 50365:2002 (1.000 Volt)

ACCESSORIES





COLORS



DYNAMO

MOUNTAINEERING HELMET

- Ideal for mountaineering, rock climbing, rescue, work at height and forestry.
- Removable headband.
- Slots for ear protectors quick fixing system.
- Quick release system.
- Ventilation through 6 holes.
- Adjustable chinstrap.
- Headlamp clips.
- Adjustable and removable chinstrap.

Accessories

- Short visor
- Long visor

Color : Red, White, Blue, Orange, Yellow, Green, Black
Size : 55/63 cm (Adjustable)
Weight : 350 gr
Outer shell: Thermo ABS
Inner shell : High Tenacity polystyrene EPS foam
Standard : EN 12492

ACCESSORIES



1

2

3

4

5

HARNESSES

LANYARDS & SHOCK ABSORBERS

CARABINERS

PULLEYS

ASCENDERS

DESCENDERS

HELMETS

MOBILE FALL ARRESTERS

RETRACTABLE FALL ARRESTERS

RESCUE DEVICES

STRETCHERS

ROPES

BAGS AND ACCESSORIES

SAFETY NETS

EDGE PROTECTION

TRIPOD AND CANTILEVER ARMS

ANCHORAGES

HORIZONTAL LIFELINE

VERTICAL LIFELINE

DEFENCE

LIFTING EQUIPMENT





MOBILE FALL ARRESTERS



RP-500 ROCKER



RP-892 RED

ROPE GRABS FOR DOUBLE SAFETY

Designed to be used hands-free when travelling up and down the rope. Allows users to be 'parked' at any position on the rope for work positioning. Can be fitted to the rope at any point.



RP-209

ALUMINUM ROPE GRABS

Allows users to be 'parked' at any position on the rope for work positioning. Lightweight for being Aluminum. RP-209 can be fitted to the rope at any point.



RG-5

STEEL ROPE GRABS

- Simple design.
- Can be fitted to the rope at any point.
- Can be used for work restraint purpose.



RG-5P



RG-5 K-4 AP

MOBILE VERTICAL LIFELINE WITH TELESCOPIC RESCUE POLE

Allow users to set up vertical lifeline (rope).

HARNESSES

LANYARDS &
SHOCK ABSORBERS

CARABINERS

PULLEYS

ASCENDERS

DESCENDERS

HELMETS

**MOBILE FALL
ARRESTERS**

RETRACTABLE
FALL ARRESTERS

RESCUE DEVICES

STRETCHERS

ROPES

BAGS AND
ACCESSORIES

SAFETY NETS

EDGE PROTECTION

TRIPOD AND
CANTILEVER ARMS

ANCHORAGES

HORIZONTAL
LIFELINE

VERTICAL LIFELINE

DEFENCE

LIFTING
EQUIPMENT



RP-500 ROCKER
ROPE GRAB

- Can be fitted to the rope at any point.
- It can be used hands-free, when travelling up and down the rope.
- The Rocker has been designed for use without a Shock-absorber.
- The Rocker can also be used as a Rope Adjuster on a Work Positioning Lanyard (in accordance with EN358).

Weight : 164 gr
Material : Aluminum
Rope Dia : Ø 10,5 – 12,7 mm
 (Use only with rope certified according to EN 1891 Type A)
Standard: CE EN 353-2, CE EN358, CE EN 12841-A



RP-892 RED
ROPE GRAB

- The RED's non-aggressive Cams have a positively locking spring, which means that the device is self-parking (rather than self-tailing, like many Rope grabs).
- Rotational Braking' feature provides the automatic braking in the event of a fall.

Weight : 210 gr
Material : Aluminum
Rope Dia: Ø 10,5 – 11 mm
 (Use only with rope certified according to EN 1891 Type A)
Standard: CE EN 12841



RP-209
MINI ROPE GRAB WITH PIN

- Allows the Rope grab to easily be added to or removed from the working rope line at any time- without the need for the user to detach from their Harness.
- Allows the user to quickly and efficiently secure the device during use.
- Manufactured from high strength aluminum material.

Weight : 183 gr
Material : Aluminum
Rope Dia : Ø 10,5 – 13 mm
 (Use only with rope certified according to EN 1891 Type A)
Standard: CE EN 353-2, EN 358 & NFPA 2001



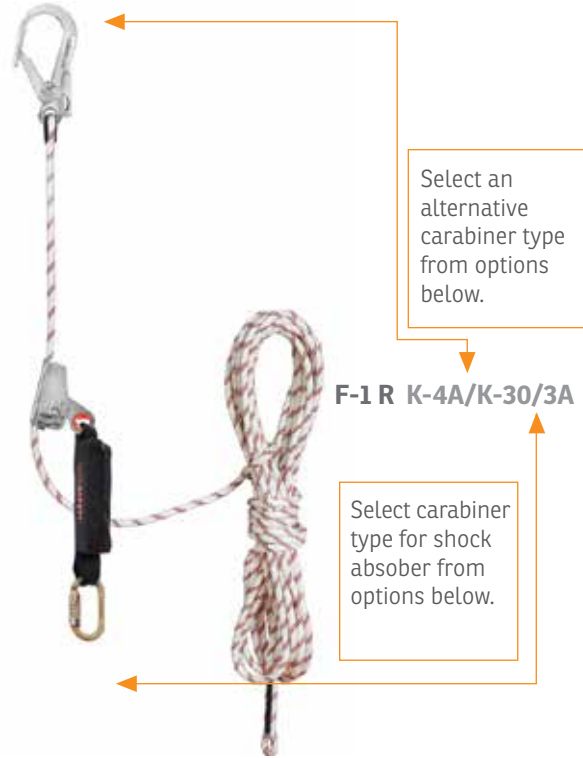

F-1
ROPE GRAB

- Simple design.
- Can be fitted to the rope at any point.
- Can be used for work restraint purpose.
- Only works with 14 mm rope certified for EN 1891.

Weight : 499 gr
Material : Stainless Steel
Rope Dia : Ø 14 mm (Only EN 1891 Tip A certified rope)
Standard: CE EN 353-2

F-1 R K-4 A /K-30/3A
MOBILE VERTICAL LIFELINE

- Designed to be used as mobile vertical lifeline.
- Comes with K-4A aluminum carabiner with 60 mm gate opening for connection to wide beams.
- RG-5 rope grab can be fitted to the rope at any point and enables users move up and down safely on mobile vertical lifelines.
- Energy absorber (E-7) designed to limit the impact transmitted to the user in case of a fall.
- Works with Ø 14 mm (EN 1891) high tenacity static rope.
- Can be used for work restrain purpose.

Rope Grab Material: Stainless Steel
Standard: EN 353-2

INDICATE CARABINER TYPE



K-30/SL K-30/3A K-4A

HARNESSES

LANYARDS & SHOCK ABSORBERS

CARABINERS

PULLEYS

ASCENDERS

DESCENDERS

HELMETS

MOBILE FALL ARRESTERS

RETRACTABLE FALL ARRESTERS

RESCUE DEVICES

STRETCHERS

ROPES

BAGS AND ACCESSORIES

SAFETY NETS

EDGE PROTECTION

TRIPOD AND CANTILEVER ARMS

ANCHORAGES

HORIZONTAL LIFELINE

VERTICAL LIFELINE

DEFENCE

LIFTING EQUIPMENT



F-1 R-4 AP

MOBILE VERTICAL LIFELINE WITH TELESCOPIC RESCUE POLE

- Recommended to be used as mobile vertical lifeline when accessing difficult-to-reach locations.
- Comes with K-4 AP carabiner for wide beams up to 90mm.
- Telescopic remote pole is made of Carbon fiber material and available in 6 & 12 meter.
- RG-5 rope grab can be fitted to the rope at any point and enables users move up and down safely on mobile vertical lifelines.
- Energy absorber (E-7) designed to limit the impact transmitted to the user in case of a fall.
- Works with Ø 14 mm (EN 1891) high tenacity static rope.
- Can be used for work restrain purpose.

Standard: EN 353-2

Types;

RG-5 R-4 AP TS- 5,5

Length of Rescue Pole (when closed) : 1,5 mt

Length of Rescue Pole (when opened): 5,5 mt

Length of Rope : Indicate at order

RG-5 R-4 AP TS-12

Length of Rescue Pole (when closed) : 1,8 mt

Length of Rescue Pole (when opened): 12 mt

Length of Rope : Indicate at order



F-1 RP

MOBILE VERTICAL LIFELINE WITH TELESCOPIC RESCUE POLE

- Recommended to be used as mobile vertical lifeline when accessing difficult-to-reach locations (wooden poles, concrete poles, I beam etc.).
- Mobile vertical lifeline has a flexible & shapeable design and is compatible with profiles 30 - 500 mm.
- Telescopic remote pole is made of Carbon fiber material and available in 6 & 12 meter.
- RG-5 rope grab can be fitted to the rope at any point and enables users move up and down safely on mobile vertical lifelines.
- Energy absorber (E-7) designed to limit the impact transmitted to the user in case of a fall.
- Works with Ø 14 mm (EN 1891) high tenacity static rope.
- Can be used for work restrain purpose.

Standard: EN 353-2

Types;

RG-5RP TS-5,5

Length of Rescue Pole (when closed) : 1,5 mt

Length of Rescue Pole (when opened): 5,5 mt

Length of Rope : Indicate at order

RG-5RP TS-12

Length of Rescue Pole (when closed) : 1,8 mt

Length of Rescue Pole (when opened): 12 mt

Length of Rope : Indicate at order

HARNESSES

LANYARDS &
SHOCK ABSORBERS

CARBINERS

PULLEYS

ASCENDERS

DESCENDERS

HELMETS

**MOBILE FALL
ARRESTERS**

RETRACTABLE
FALL ARRESTERS

RESCUE DEVICES

STRETCHERS

ROPES

BAGS AND
ACCESSORIES

SAFETY NETS

EDGE PROTECTION

TRIPOD AND
CANTILEVER ARMS

ANCHORAGES

HORIZONTAL
LIFELINE

VERTICAL LIFELINE

DEFENCE

LIFTING
EQUIPMENT





ACB 1,8

ACB TYPE RETRACTABLE FALL ARRESTERS

Designed to be used as fall arrester in works performed on Mobile Cranes.



HWB 1,8 DW HWB 1,8 RDW HWDB 2 HWDB 2 R

HWDB TYPE TWIN RETRACTABLE FALL ARRESTERS

Used as fall arrester for works at height.



HWPB-3,5 HWPB-5,5

HWPB TYPE RETRACTABLE FALL ARRESTERS

Designed to be used as fall arrester in works performed on Mobile Cranes.



HPS-6 HPS-12

HPS TYPE TWIN RETRACTABLE FALL ARRESTERS

Produced with high tenacity galvanized steel wire rope in plastic housing. Available in plastic or aluminum housing.



H-18 H-24 H-33 H-42 H-60

H SERIES RETRACTABLE FALL ARRESTERS

Produced with high tenacity galvanized steel wire rope in aluminum housing. Can be used as mobile vertical life line.



HRA-18 HRA-24 HRA-30 HRA-42

HRA TYPE FALL ARRESTER BLOCKS WITH RECOVERY MECHANISM

Produced with high tenacity steel wire rope in aluminum housing. Recovery mechanism allows the device to be used to lift or lower a casualty post fall, or if they have become incapacitated in a confined space.



HAS-18 HAS-30

HAS SERIES RETRACTABLE FALL ARRESTER WITH AUTOMATIC LOWERING FACILITY

Produced with high tenacity galvanized steel wire rope in aluminum housing. Can be used as mobile vertical life line. Once the fall has been arrested, the device immediately lowers the user to the ground at a constant speed of 0.9m/sec.



ABS 5 D

ABS 5D RETRACTABLE FALL ARRESTER WITH AUTOMATIC LOWERING FACILITY

The device has been specially designed for use in leisure-time sports. It has an additional backup catch function in case of an overload due to brake failures. The descender process is carried out with a speed of approx. 1.0 m/s with the centrifugal force safely regulated downward.

HARNESSES

LANYARDS & SHOCK ABSORBERS

CARABINERS

PULLEYS

ASCENDERS

DESCENDERS

HELMETS

MOBILE FALL ARRESTERS

RETRACTABLE FALL ARRESTERS

RESCUE DEVICES

STRETCHERS

ROPES

BAGS AND ACCESSORIES

SAFETY NETS

EDGE PROTECTION

TRIPOD AND CANTILEVER ARMS

ANCHORAGES

HORIZONTAL LIFELINE

VERTICAL LIFELINE

DEFENCE

LIFTING EQUIPMENT



HWB 1,8 DW



HWB 1,8 R DW

HWB 1,8 DW

DOUBLE FALL ARREST BLOCK

- Lightweight aluminum housing with a webbing lifeline.
- Swivel harness attachment point.
- Sewn in load indicator on lifeline.
- Additional testing against falls over edges.
- Aluminum double action hooks on end of lifelines.
- Designed for the block to be attached to the safety harness.

Standard: EN 360, CNB 11.060: 2008 Sharp Edge Type A

Product Type

HWB 1,8 DW

Length : 1,8 m
Weight : 2,26 kg
Carabiner gate opening: 24 mm

HWB 1,8 R DW

Length : 1,8 m
Weight : 3,51 kg
Carabiner gate opening: 60 mm





ACB-1,8
RETRACTABLE
FALL ARRESTER

- Designed for fall protection in mobile elevated working platforms.
- The self-retracting lanyard is tested and certified for the protection in mobile elevated working Platforms.
- The lanyard is tested over a 'double' sharp edge.
- Innovative technique in the area of internal energy absorbers ensures a maximum arresting force of less than 3 kN at the anchorage point.
- Aluminum Housing.

Length : 1,8 m
Weight : 0,96 kg
Standard: EN 360, CNB 11060 2008
Type A



HWDB 2
RETRACTABLE
FALL ARRESTER

- Low-maintenance double height-safety device for securing one person against falling.
- Specially designed for the secure job change by alternately striking and a continuous protection against crash.
- Webbing with case indicators and 2x2 m extension length.
- Case-absorbing function in an aluminum housing.

Length : 2 m
Weight : 1,9 kg
Standard: EN 360



HWDB 2 R
RETRACTABLE
FALL ARRESTER

- Aluminum housing with webbing strap: Especially resistant against acids, caustic solutions, heat, cold, damp and other extreme situations.
- Turn-hook hanging which stops the strap from twisting.
- Compact construction and low weight.
- For fall protection for one person.

Length : 2 m
Weight : 2,8 kg
Standard: EN 360



HARNESSES

LANYARDS &
SHOCK ABSORBERS

CARABINERS

PULLEYS

ASCENDERS

DESCENDERS

HELMETS

MOBILE FALL
ARRESTERS

RETRACTABLE
FALL ARRESTERS

RESCUE DEVICES

STRETCHERS

ROPES

BAGS AND
ACCESSORIES

SAFETY NETS

EDGE PROTECTION

TRIPOD AND
CANTILEVER ARMS

ANCHORAGES

HORIZONTAL
LIFELINE

VERTICAL LIFELINE

DEFENCE

LIFTING
EQUIPMENT



HWPB SERIES
RETRACTABLE FALL ARRESTER

- Low maintenance device fitted with a webbing lifeline.
- The attachment anchorage point on the fall arrest block is a cast aluminum swivel eye $\varnothing 16\text{mm}$, suitable for connection via a standard karabiner type connector, or a standard karabiner type connector with an Anchorage Sling.
- Plastic housing.
- Fall arrest block has been tested in a simulated fall over an edge.
- Fitted with a 25 mm webbing lifeline.

Standard: EN 360, CNB 11.060 2008 Sharp Edge Type A

Product Types

HWPB-3,5
Length: 3,5 m
Weight: 1,2 kg

HWPB-5,5
Length: 5,5 m
Weight: 1,5 kg



HPS SERIES
RETRACTABLE FALL ARRESTER

- Low-maintenance height-safety device with galvanized steel wire rope.
- Plastic housing.
- The snap hook with a fall indicator.

Standard: EN 360, CNB 11.060 2008 Sharp Edge Type A

Product Types

HPS-6
Length: 6 m
Weight: 2,8 kg

HPS-12
Length: 12 m
Weight: 4 kg





H SERIES

RETRACTABLE FALL ARRESTER

- This aluminum housed fall arrest block is a sturdy, low maintenance device fitted with a steel rope lifeline, terminated with a steel double action hook.
- The attachment anchorage point on the fall arrest block is an open steel handle, suitable for connection via a standard karabiner type connector, or a standard karabiner type connector with an anchorage sling, or a large karabiner.
- Fall arrest block has been tested in a simulated fall over an edge.

Standard: EN 360, CNB 11.060 2008 Keskin Kenar Tip A

Product Types

H-18

Length: 18 m

Weight: 9,5 kg

H-24

Length: 24 m

Weight: 13,5 kg

H-33

Length: 30 m

Weight: 18 kg

H-42

Length: 42 m

Weight: 26,8 kg

H-60

Length: 60 m

Weight: 38 kg



HARNESSES

LANYARDS &
SHOCK ABSORBERS

CARABINERS

PULLEYS

ASCENDERS

DESCENDERS

HELMETS

MOBILE FALL
ARRESTERS

RETRACTABLE
FALL ARRESTERS

RESCUE DEVICES

STRETCHERS

ROPES

BAGS AND
ACCESSORIES

SAFETY NETS

EDGE PROTECTION

TRIPOD AND
CANTILEVER ARMS

ANCHORAGES

HORIZONTAL
LIFELINE

VERTICAL LIFELINE

DEFENCE

LIFTING
EQUIPMENT



HRA SERIES

RETRACTABLE FALL ARRESTER WITH RECOVERY MECHANISM

- This aluminum housed fall arrest block is a sturdy, low maintenance device fitted with a steel rope lifeline, terminated with a steel double action hook.
- The attachment anchorage point on the fall arrest block is an open steel handle, suitable for connection via a standard karabiner type connector, or a standard karabiner type connector with an anchor age sling, or a large karabiner.
- This fall arrest block also has a built in recovery mechanism, which is engaged by pulling a pin on the side of the block and engaging a winding handle. This then allows the device to be used to lift or lower a casualty post fall, or if they have become incapacitated in a confined space.
- Fall arrest block has been tested in a simulated fall over an edge.

Standard: EN 360, EN 1496

Product Types

HRA-18
Length: 18 m
Weight: 11,5 kg

HRA-30
Length: 30 m
Weight: 18,5 kg

HRA-24
Length: 24 m
Weight: 16 kg

HRA-42
Length: 42 m
Weight: 25,5 kg



2xr 0,5 mm



HAS SERIES

RETRACTABLE FALL ARRESTER WITH CONTROLLED DESCENT

- Easy to use, low-maintenance design.
- Load carrying capacity: > 1 person, 125kg - max.
- Fall Arrest Block with integral controlled descent mechanism with a 16.0m steel rope lifeline in an aluminum housing.
- This aluminum housed fall arrest block is a sturdy, low maintenance device fitted with a steel rope lifeline, terminated with a steel double action hook.
- This device functions in the same way as a conventional fall arrest block, however once the fall has been arrested, the device immediately lowers the user to the ground at a constant speed of 0.9m/sec.
- The attachment anchorage point on the fall arrest block is an open steel handle, suitable for connection via a standard karabiner type connector, or a standard karabiner type connector with an anchorage sling, or a large karabiner.

Standard: EN 341

Product Types

HAS-18
Length: 18 m
Weight: 11 kg

HAS-30
Length: 30 m
Weight: 15 kg



2xr 0,5 mm



ABS 5 D RETRACTABLE FALL ARRESTER WITH AUTOMATIC LOWERING FACILITY

- This device works with a permanent descender brake, thus eliminating any possibilities of a crash in the system.
- The descender process is carried out with a speed of approx. 1.0 m/s with the centrifugal force safely regulated downward.
- A freewheel enables a non-braked retraction of the fastener.
- The digital counter measures the rotations of the rope drum and indicates the permissible, completed work (10,000m) of the device at a corresponding counter reading.

Length : 10 m
Weight : 6 kg
Standard: EN 341



HARNESSES

LANYARDS &
SHOCK ABSORBERS

CARABINERS

PULLEYS

ASCENDERS

DESCENDERS

HELMETS

MOBILE FALL
ARRESTERS

RETRACTABLE
FALL ARRESTERS

RESCUE DEVICES

STRETCHERS

ROPES

BAGS AND
ACCESSORIES

SAFETY NETS

EDGE PROTECTION

TRIPOD AND
CANTILEVER ARMS

ANCHORAGES

HORIZONTAL
LIFELINE

VERTICAL LIFELINE

DEFENCE

LIFTING
EQUIPMENT





BISON ABS 4WH

BISON ABS 4WH RESCUE DEVICE

Designed for the rescue of a worker left suspended at height after a fall. The abseiling test with the IKAR "Bison" was done with a maximum abseiling height (150 mt) and a maximum load of 200kg (equates to 3,800 abseiling meter). Also the function test with an overload of 25 % (250 kg) at a height of 150 mt was not a problem for the "Bison".



MARK ELEPHANT HUB

DESCENDER, RESCUE AND LIFTING DEVICE

Designed for emergency rescue and evacuation situations.



FAWORIT ABS 3a WH

FAWORIT ABS 3a WH RESCUE DEVICE

Designed for the rescue of a worker left suspended at height after a fall. This abseiling device has an automatic speed regulation. The brake controlled by centrifugal forces keeps the speed of the device constant during the entire abseiling and enables a rapid and safe rescue. The device is also equipped with a rescue hoisting facility using a crank wheel and a reverse lock which can latch into place. As an additional safety feature shock absorption while lifting is integrated. Device has been tested and approved for one person (100 Kg) abseiling heights up to 150 mt.



41 Z19 TELESCOPIC RESCUE POLE



FAWORIT ABS 3a W

FAWORIT ABS 3a W ABSEILING DEVICE

This abseiling device has an automatic speed regulation. The brake controlled by centrifugal forces keeps the speed of the device constant during the entire abseiling process and enables a rapid and safe rescue. The Abseiling speed can be regulated by the rescuer on the opposite rope. The maximum Abseiling work of the device is 10.000 Abseiling meter.

HARNESSES

LANYARDS & SHOCK ABSORBERS

CARABINERS

PULLEYS

ASCENDERS

DESCENDERS

HELMETS

MOBILE FALL ARRESTERS

RETRACTABLE FALL ARRESTERS

RESCUE DEVICES

STRETCHERS

ROPES

BAGS AND ACCESSORIES

SAFETY NETS

EDGE PROTECTION

TRIPOD AND CANTILEVER ARMS

ANCHORAGES

HORIZONTAL LIFELINE

VERTICAL LIFELINE

DEFENCE

LIFTING EQUIPMENT



**IKAR BISON
ABS 4WH
RESCUE DEVICE**

- High functional safety.
- Innovative construction, corrosion-resistant.
- Resistant to damp, heat, cold.
- Integral rescue hoisting function using a crank wheel.
- Maximum load 200 kg.
- Reverse lock which can latch into place.
- Abseiling speed approx. 0.9 m/sec.
- For abseiling heights up to 150 mt, Maximum lifting height: 75 mt.
- Compact, stable size.
- Does not cause undue wear or damage to the rope.
- Tested for two persons.
- Rope delivered with a bag.

Length : 20-150 m
Weight : 2.800 gr
 (20 mt standard weight)
Standard: EN 341, EN 1496



**IKAR FAVORIT
ABS 3aWH
RESCUE DEVICE**

- High functional safety.
- Innovative construction, corrosion-resistant.
- Resistant to damp, heat, cold.
- Abseiling speed approx. 0.9 m/sec.
- For abseiling heights up to 150 mt.
- Compact, stable size.
- Reverse lock which can latch into place.
- Maximum lifting height: 75 mt.
- Automatic speed regulation.
- Integral rescue hoisting function using a crank wheel.
- Extremely low on weight.
- Does not cause undue wear or damage to the rope.
- Tested for one person.
- Rope delivered with a bag (10,5 mm static (EN 1891 certified) rope).

Length : 20-150 m
Weight : 1.900 gr
 (20 mt standard weight)
Standard: EN 341, EN 1496



**41 Z19
TELESCOPIC REMOTE REACH
RESCUE POLE**

- The pole is fitted with a mounting bracket.
- Minimum length is 80 cm and 292 cm when extended.
- Weight is only 510 gr.



IKAR FAVORIT ABS 3aW AUTOMATIC ABSEILING DEVICE

- High functional safety.
- Innovative construction, corrosion-resistant.
- Resistant to damp, heat, cold.
- Abseiling speed approx. 0.9 m/sec.
- For abseiling heights up to 150 mt.
- Compact, stable size.
- Aluminum external case.
- Extremely low own weight.
- Aluminum version with Twist lock karabiner.
- Simple installation via F-7 anchorage sling.
- Delivered with K-2/3ACP automatic lock karabiner.
- Does not cause undue wear or damage to the rope.
- Tested for one person.
- Rope delivered with a bag (10,5 mm static EN 1891 certified) rope.

Length : 20 - 150 mt
Weight : 1.200 gr (20 mt Standard weight)
Standard: EN 341:1996 Class A



RK-SERIES RESCUE KIT

- Safe, Quick & easy solution for rescuing a suspended worker.
- R-ALF rescue pulley is used as part of work suspension system either in confined spaces as a user can easily lift/lower themselves.
- If the user loses control of the decent the over speed brake will automatically kick in.
- Has 11 mm static rope (EN 1891).
- Easy to attach wide profiles with F-2 anchorage sling.
- Comes with Aluminum telescopic remote reach rescue pole.

Standard: EN 12278, ANSI Z359: 4: 2007

Product Types

RK-20
Length: 20 m
Weight: 12.220 gr
 (rope included)

RK-40
Length: 4m
Weight: 20.220 gr
 (rope included)

HARNESSES

LANYARDS & SHOCK ABSORBERS

CARABINERS

PULLEYS

ASCENDERS

DESCENDERS

HELMETS

MOBILE FALL ARRESTERS

RETRACTABLE FALL ARRESTERS

RESCUE DEVICES

STRETCHERS

ROPES

BAGS AND ACCESSORIES

SAFETY NETS

EDGE PROTECTION

TRIPOD AND CANTILEVER ARMS

ANCHORAGES

HORIZONTAL LIFELINE

VERTICAL LIFELINE

DEFENCE

LIFTING EQUIPMENT



MARK ELEPHANT HUB

DESCENDER, RESCUE AND LIFTING DEVICE

- Designed for emergency rescue and evacuation situations.
- Load capacity a max. of 225 kg.
- Descent speed approx. 0.8m/sec.
- Descent height a max. of 300 mt.
- Housing: steel/aluminum combination.
- Works with Ø 9,6 mm (EN 1891) high tenacity static rope.

Standard : EN 341:2011 - 1A / EN 1496:2007 Class B





DE-100
DERRICKMAN ESCAPE SYSTEM

- The Derrickman Escape Chute is designed to provide a rapid and safe method of evacuation in an emergency event from offshore and onshore rigs.
- Escape with ABS 3W device - Abseiling speed approx. 0.9 m/sec.
- System legs are mounted on 1 m³ of concrete block.

Standard: EN 341

HARNESSES

LANYARDS &
SHOCK ABSORBERS

CARABINERS

PULLEYS

ASCENDERS

DESCENDERS

HELMETS

MOBILE FALL
ARRESTERS

RETRACTABLE
FALL ARRESTERS

RESCUE DEVICES

STRETCHERS

ROPES

BAGS AND
ACCESSORIES

SAFETY NETS

EDGE PROTECTION

TRIPOD AND
CANTILEVER ARMS

ANCHORAGES

HORIZONTAL
LIFELINE

VERTICAL LIFELINE

DEFENCE

LIFTING
EQUIPMENT





RL-10 CONIC RESCUE STRETCHER

CONIC STRETCHER - RESCUE STRETCHER

Designed for confined space, high angle or technical rescue, and traditional land based applications. Equipped with 2 pieces of 35 kN slings for horizontal hoisting by helicopter or vertical hoisting in caves or industrial confined spaces. The stretcher is rolled for storage in a tough backpack which is included with the system.



RL-46

NEIL ROBERTSON STRETCHER

Designed for removing an injured person from spaces wherein access, doors, or hatches are too small to permit the use of regular stretchers.



RL-6

BASKET STRETCHERS

These types of stretchers are designed for carrying injured person by helicopter or winch and made of Stainless Steel, Steel or HDPE material.



RL-4



RL-44

SPINE BOARD STRETCHERS

These stretchers are widely used in First Aid, Ambulance Car, as an equipment to move the injured people. Compatible with Head Immobilizer and Neck collar.



RL-44 A



RL-5

SCOOP STRETCHER

Scoop Stretcher eliminates the need for log-roll maneuvers, which significantly decreases movement to the cervical spine. The Scoop is also ideal for hip injuries and for accident victims found on the street.

HARNESSES

LANYARDS & SHOCK ABSORBERS

CARABINERS

PULLEYS

ASCENDERS

DESCENDERS

HELMETS

MOBILE FALL ARRESTERS

RETRACTABLE FALL ARRESTERS

RESCUE DEVICES

STRETCHERS

ROPES

BAGS AND ACCESSORIES

SAFETY NETS

EDGE PROTECTION

TRIPOD AND CANTILEVER ARMS

ANCHORAGES

HORIZONTAL LIFELINE

VERTICAL LIFELINE

DEFENCE

LIFTING EQUIPMENT



RL-10

CONIC STRETCHER

- Ideal for confined space, high angle or technical rescue, and traditional land based applications.
- Equipped with 2 pieces of 35 kN slings for horizontal hoisting by helicopter or vertical hoisting in caves or industrial confined spaces.
- When the patient is packaged the stretcher becomes rigid.
- Main body is made of high strength polyethylene material.
- Eyelets rivets on the belts are made of stainless steel.
- 1 piece of 23 Kn strength vertical evacuation rope.
- 4 pieces of handles (2for each on left and right side of the stretcher).
- 4 pieces of slings to be connected on eyelets rivets.
- 1 pcs of 50 kN triple action karabiner.
- The stretcher is rolled for storage in a tough backpack which is included with the system.
- Stretcher dia is 27 cm and length is 93 cm when rolled.
- Stretcher back bag sizes: 31 cm x 95 cm (Dia x Length), stretcher sizes 27x 93 x 250 cm (Dia x Width x Length).

Weight : 8,4 kg

Standard: EN 1865



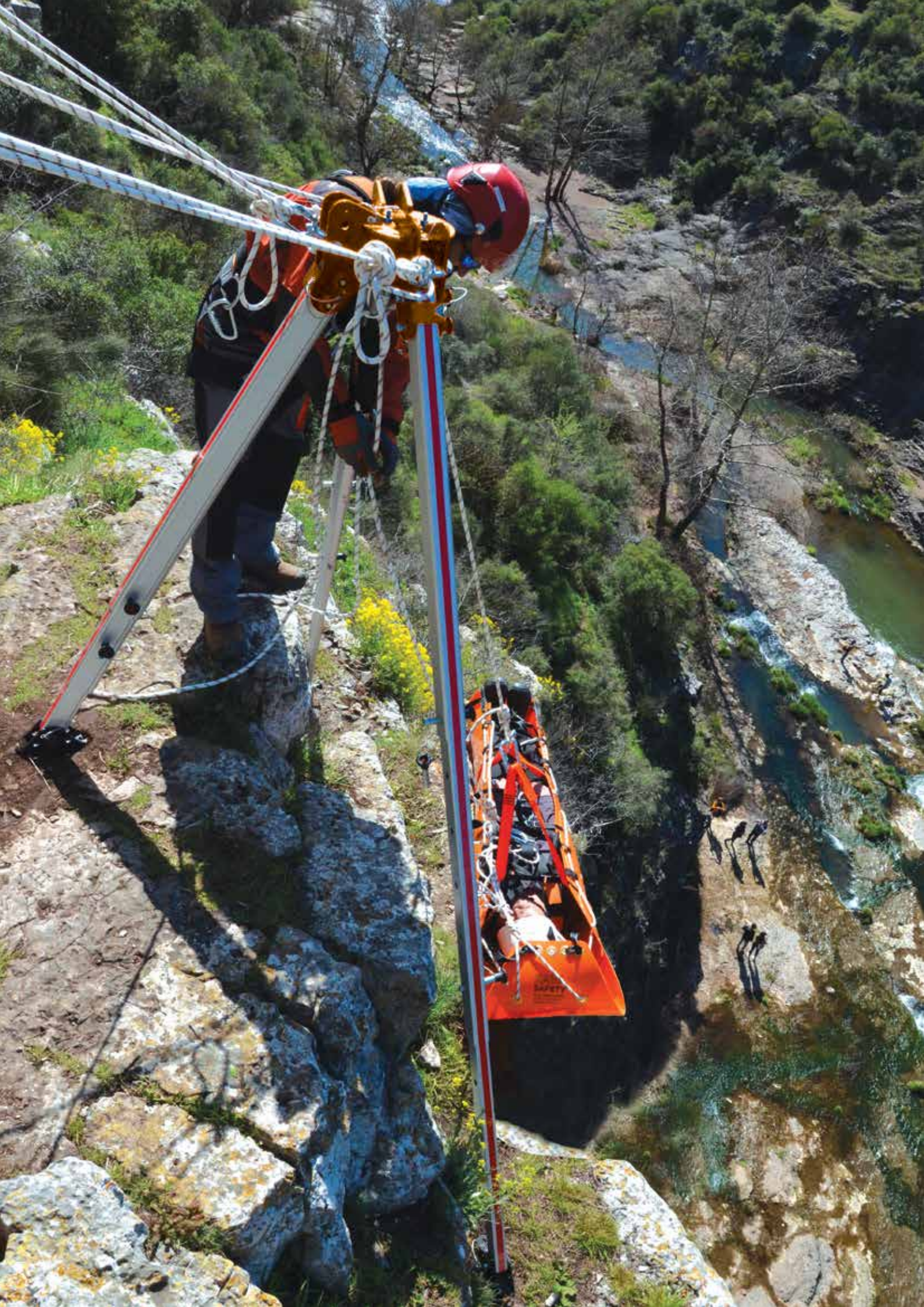



RL-6
BASKET STRETCHER

- Shaped to accommodate an adult in a face up position.
- Used in search & rescue operations.
- Ideal for lifting and transporting by helicopter.
- Supports four point bridle (optional).

Material : Stainless Steel 316
Carrying Strength: 22 kN
Width : 59 cm
Length : 210 cm
Height : 20 cm
Weight : 12 kg

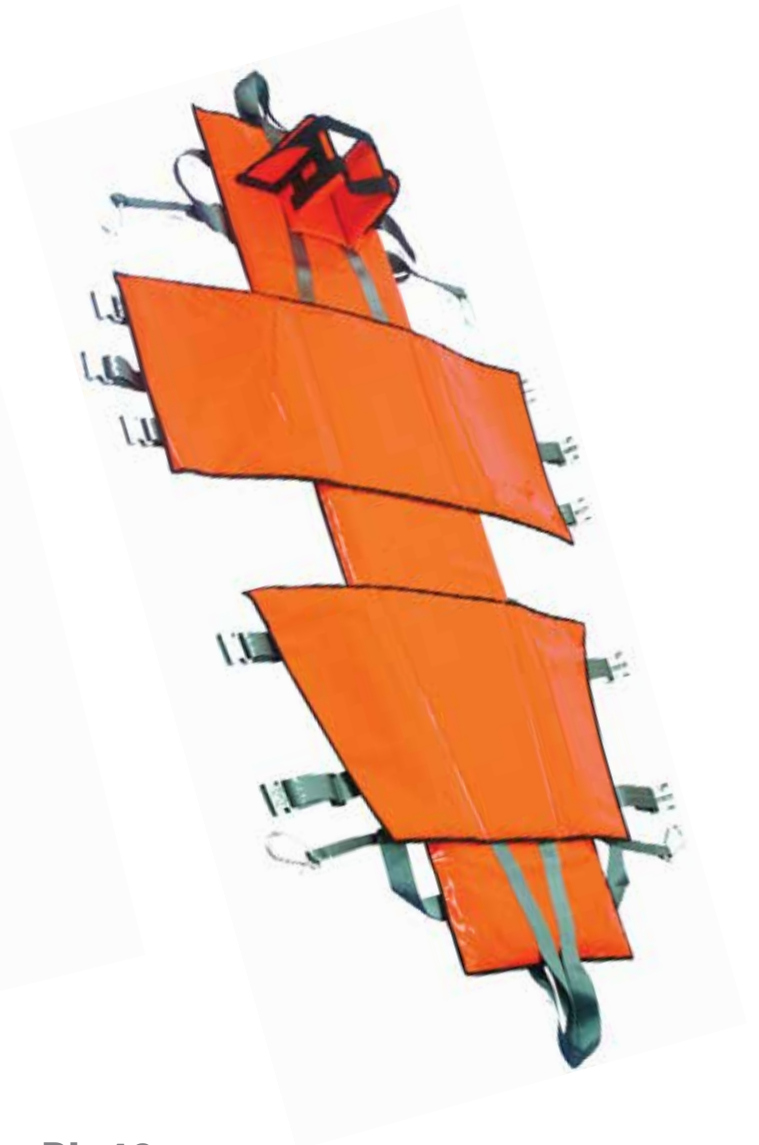

RL-46
NEIL ROBERTSON STRETCHER

- Lightweight and compact compared to other stretchers, provides more freedom of movement and flexibility of use.
- Designed for removing an injured person from spaces wherein access, doors, or hatches are too small to permit the use of regular stretchers.
- Can be used for Horizontal or Vertical Rescue.
- Can be used together with the Spine Boards.
- Made of Fire retardant, friction and tear resistant 1100 denier Polyester/PVC canvas.
- Provided with 8 carrying straps to hold the person with almost negligible movement with respect to stretcher.

Carrying Capacity: 150 kg
Width : 65 cm
Length : 195 cm
Height : 6 cm
Weight : 4,5 kg
Standard : EN 1865



HEAD IMMOBILIZER



SAFETY BELT

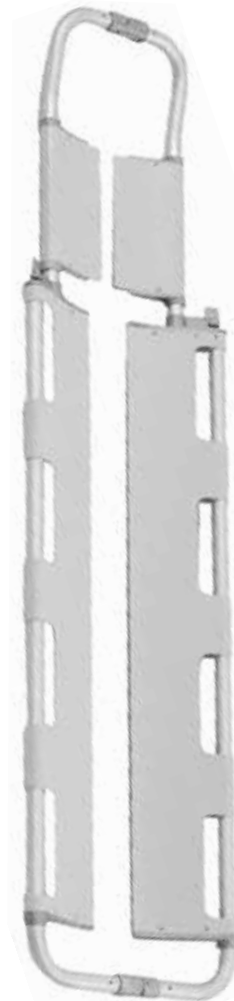

RL-4
BASKET STRETCHERS (PLASTIC)

- It can be used together with the Spine Boards.
- HDPE Body.
- Hand holes for easy transporting.
- Four point lifting bridle.

Carrying Capacity : 175 kg
Width : 63 cm
Length : 217 cm
Height : 20 cm
Weight : 14 kg

RL-44
SPINE BOARD STRETCHERS

- Compatible with most head immobilizer.
- Outer body is made of high tenacity ABS material, Inner core is made of high-intensity PU.
- X-ray translucent.

Carrying Capacity: 250 kg
Width : 45 cm
Length : 185 cm
Height : 4 cm
Weight : 5,4 kg
Standard : EN 1865

- Optional Accessories**
- Head immobilizer
 - Safety Belt

RL-5
SCOOP STRETCHER

- A scoop stretcher has a structure that can be split vertically into two parts.
- Open-center design permits patient to be X-rayed.
- Telescoping tubes allow length adjustments to fit patients of various heights.

Carrying Capacity : 170 kg
Width : 42 cm
Length : 166 cm
Height : 7 cm
Weight : 10 kg
Standard : EN 1865

HARNESSES

LANYARDS & SHOCK ABSORBERS

CARABINERS

PULLEYS

ASCENDERS

DESCENDERS

HELMETS

MOBILE FALL ARRESTERS

RETRACTABLE FALL ARRESTERS

RESCUE DEVICES

STRETCHERS

ROPES

BAGS AND ACCESSORIES

SAFETY NETS

EDGE PROTECTION

TRIPOD AND CANTILEVER ARMS

ANCHORAGES

HORIZONTAL LIFELINE

VERTICAL LIFELINE

DEFENCE

LIFTING EQUIPMENT





LUPA® STATIC 10.5 LUPA® STATIC 11 LUPA® STATIC 12 LUPA® STATIC 13 LUPA® STATIC 11 (EYELET) LUPA® ACCESSORY

STATIC ROPES

Static ropes are an ideal solution for rappelling, rescue operations and instructional use.



ARAMID FIGHTER

ARAMID FIGHTER

Specially designed for the activities involved in hot working environments. Ideal solution for firefighters and foresters in emergency situations and rescue operations.



LUPES® SAFETY TWIST

LUPES® SAFETY TWIST

Personal safety rope is designed to work with systems having F-2 It is also suitable to use with F-3 and F-1.



LOOP TYPES



LUPA® FAST ROPE

M

SE

LUPA® FAST ROPE

Fast Rope is useful for deploying troops from a helicopter in places where the helicopter itself cannot touch down.



ERC-100



RP-100



RP-50



G-18



G-18 A

ROPE PROTECTORS

Designed to protect rope from sharp edges.

RAPPELLING GLOVES

Designed for rope access professionals.

HARNESSES

LANYARDS & SHOCK ABSORBERS

CARABINERS

PULLEYS

ASCENDERS

DESCENDERS

HELMETS

MOBILE FALL ARRESTERS

RETRACTABLE FALL ARRESTERS

RESCUE DEVICES

STRETCHERS

ROPES

BAGS AND ACCESSORIES

SAFETY NETS

EDGE PROTECTION

TRIPOD AND CANTILEVER ARMS

ANCHORAGES

HORIZONTAL LIFELINE

VERTICAL LIFELINE

DEFENCE

LIFTING EQUIPMENT



LUPA® STATIC 10,5 MM

- Designed for rescue operations and rope access techniques.
- Made of High Tenacity Polyamide Fiber (S/Z Twist).
- Formed by core and protector cover.
- Excellent hand-grip feature.
- High resistance against abrasion.
- High UV resistance.
- Identification tape inserted (with information of relative standard, type of rope, brand).

Dia	: 10,5 mm
Standard	: EN 1891
Type	: A
Weight	: 67 gr/mt
Breaking Strength	: 27 kN
Breaking Strength with Knot:	18 kN
Static Stretching	: % 2,7
Sheath Slippage	: 0
Wet Tensile Strength	: % 3,3
Knot Flexibility	: 1
Stitched Eyes Strength	: 24 kN
Eight Knot Strength	: 16 kN

Standard Lengths;

- 50, 100, 150 & 200 Meter White With Dots
- 50, 100, 150 & 200 Meter Grey With Dots
- 50, 100, 150 & 200 Meter Plain Black

LUPA® STATIC 11 MM

- Designed for rescue operations, rope access techniques and difficult work environments.
- Made of High Tenacity Polyamide Fiber (S/Z Twist).
- Formed by core and protector cover.
- Excellent hand-grip feature.
- High resistance against abrasion.
- High UV resistance.
- Identification tape inserted (with information of relative standard, type of rope, brand).

Dia	: 11 mm
Standard	: EN 1891
Type	: A
Weight	: 78 gr/mt
Breaking Strength	: 28 kN
Breaking Strength with Knot:	19 kN
Static Stretching	: % 2,7
Sheath Slippage	: 0
Wet Tensile Strength	: % 3,3
Knot Flexibility	: 1
Stitched Eyes Strength	: 25 kN
Eight Knot Strength	: 16 kN

Standard Lengths;

- 50, 100, 150 & 200 Meter White With Dots
- 50, 100, 150 & 200 Meter Grey With Dots
- 50, 100, 150 & 200 Meter Plain Black





LUPA® STATIC 11 MM (EYELET)

- Designed for rescue operations and rope access techniques.
- Made of High Tenacity Polyamide Fiber (S/Z Twist).
- Formed by core and protector cover.
- Excellent hand-grip feature.
- High resistance against abrasion.
- High UV resistance.
- Identification tape inserted (with information of relative standard, type of rope, brand).

Dia	: 11 mm
Standard	: EN 1891
Type	: A
Weight	: 78 gr/mt
Breaking Strength	: 28 kN
Breaking Strength with Knot:	19 kN
Static Stretching	: % 2,7
Sheath Slippage	: 0
Wet Tensile Strength	: % 3,3
Knot Flexibility	: 1
Stitched Eyes Strength	: 25 kN
Eight Knot Strength	: 16 kN

Standard Lengths;

- 50, 100, 150 & 200 Meter White With Dots
- 50, 100, 150 & 200 Meter Grey With Dots
- 50, 100, 150 & 200 Meter Plain Black



LUPA® ACCESSORY 7 MM

- Designed to pull and lift up materials.
- Made of High Tenacity Polyamide Fiber (S/Z Twist).
- Formed by core and protector cover.
- Excellent hand-grip feature.
- High resistance against abrasion.
- High UV resistance.

Dia	: 7 mm
Standard	: EN 564
Type	: A
Weight	: 32 gr/mt
Breaking Strength	: 13 kN
Breaking Strength with Knot:	7 kN
Wet Tensile Strength	: % 3,3
Stitched Eyes Strength	: 10 kN
Eight Knot Strength	: 7,5 kN

Standard Lengths;

- 50, 100, 150 & 200 Meter White With Dots
- 50, 100, 150 & 200 Meter Orange With Dots
- 50, 100, 150 & 200 Meter Plain Black



HARNESSES

LANYARDS & SHOCK ABSORBERS

CARABINERS

PULLEYS

ASCENDERS

DESCENDERS

HELMETS

MOBILE FALL ARRESTERS

RETRACTABLE FALL ARRESTERS

RESCUE DEVICES

STRETCHERS

ROPES

BAGS AND ACCESSORIES

SAFETY NETS

EDGE PROTECTION

TRIPOD AND CANTILEVER ARMS

ANCHORAGES

HORIZONTAL LIFELINE

VERTICAL LIFELINE

DEFENCE

LIFTING EQUIPMENT



LUPA® STATIC 11 MM (EYELET)

- Designed for rescue operations and rope access techniques.
- Made of High Tenacity Polyamide Fiber (S/Z Twist).
- Formed by core and protector cover.
- Excellent hand-grip feature.
- High resistance against abrasion.
- High UV resistance.
- Identification tape inserted (with information of relative standard, type of rope, brand).

Dia	: 11 mm
Standard	: EN 1891
Type	: A
Weight	: 78 gr/mt
Breaking Strength	: 28 kN
Breaking Strength with Knot:	19 kN
Static Stretching	: % 2,7
Sheath Slippage	: 0
Wet Tensile Strength	: % 3,3
Knot Flexibility	: 1
Stitched Eyes Strength	: 25 kN
Eight Knot Strength	: 16 kN

Standard Lengths;

- 50, 100, 150 & 200 Meter White With Dots
- 50, 100, 150 & 200 Meter Grey With Dots
- 50, 100, 150 & 200 Meter Plain Black

LUPA® ACCESSORY 7 MM

- Designed to pull and lift up materials.
- Made of High Tenacity Polyamide Fiber (S/Z Twist).
- Formed by core and protector cover.
- Excellent hand-grip feature.
- High resistance against abrasion.
- High UV resistance.

Dia	: 7 mm
Standard	: EN 564
Type	: A
Weight	: 32 gr/mt
Breaking Strength	: 13 kN
Breaking Strength with Knot:	7 kN
Wet Tensile Strength	: % 3,3
Stitched Eyes Strength	: 10 kN
Eight Knot Strength	: 7,5 kN

Standard Lengths;

- 50, 100, 150 & 200 Meter White With Dots
- 50, 100, 150 & 200 Meter Orange With Dots
- 50, 100, 150 & 200 Meter Plain Black







ARAMID FIGHTER

- Made of % 100 Kevlar (Flame retardant)
- 300°C working temperature
- Formed by core and protector cover
- Excellent hand-grip feature
- High resistance against abrasion
- Extremely low stretch
- No creep under constant loads

DIA (Ø)	WEIGHT (kg/100 mt)	B. STRENGTH (kgf)
8	5,60	2.100
10	8,75	3.180
11	10,58	4.000
12	12,60	4.600
14	17,15	6.200
16	22,40	8.000

Standard Lengths;

- 50 m
- 100 m
- 150 m
- 200 m



LUPES® SAFETY TWIST

- Made of % 100 High Tenacity Polyester Fibers.
- 3 strands twisted.
- High durability.
- Excellent hand-grip feature.
- High resistance against abrasion.
- Easy to splice.
- Durable.

DIA (Ø)	WEIGHT (kg/100 mt)	B. STRENGTH (kgf)
12	10,90	2.875
14	14,90	3.875
16	19,40	5.000

Standartlad: TS EN ISO 1141

Standard Lengths;

- 100 m
- 200 m





LOOP TYPES



M



SE

ART. NO	DIA	WEIGHT	B. STRENGTH
	(Ø)	(kg/100 mt)	(kgf)
051 0323	2	42,00	7.500
051 040	40	60,00	10.000
051 044	44*	77,00	12.000

* Dia if not under load: Ø : 50 mm



LUPA® FAST ROPE

- Material** : High Tenacity Mat Polyamide Fiber
- Construction** : 8 Strands
- Features** : Very Good Abrasion Resistance, High Durability
- Max. Elongation at Break:** % 59
- Density** : 1,14 kg/dm³
- Color** : Military Green/Desert Sand
- Standard** : MIL-F-44422
- Length** : 30 / 60 / 90 / 120 Feet Coil



HARNESSES

LANYARDS & SHOCK ABSORBERS

CARABINERS

PULLEYS

ASCENDERS

DESCENDERS

HELMETS

MOBILE FALL ARRESTERS

RETRACTABLE FALL ARRESTERS

RESCUE DEVICES

STRETCHERS

ROPES

BAGS AND ACCESSORIES

SAFETY NETS

EDGE PROTECTION

TRIPOD AND CANTILEVER ARMS

ANCHORAGES

HORIZONTAL LIFELINE

VERTICAL LIFELINE

DEFENCE

LIFTING EQUIPMENT



ERC-100
ROPE PROTECTOR

- Designed to guide and protect a moving and stationary rope from abrasion and sharp edges.
- Lightweight modules connected by quick links to follow the contours of the surface.
- Supplied in kit form.
- Kit includes 4 modules and 6 quick links for assembly.

RP-100
ROPE PROTECTOR

- Protects rope against abrasion on rough surfaces and edges.
- Velcro closure makes it easy to put on and remove from the rope at any time
- Inner part is made of high tenacity fabric.
- Available in 1,20 mt.

RP-50
ROPE PROTECTOR

- Protects rope against abrasion on rough surfaces and edges.
- Velcro closure makes it easy to put on and remove from the rope at any time
- Thick canvas construction for increased protection.
- Available in 1,20 mt.





G-18
RAPPELLING GLOVES (FULL-FINGER)

- Ideal for abseiling and rescue.
- Premium synthetic leather palm and fingertip patches.
- Velcro wrist fastening.
- Full finger.

Standard: EN 388:2003 (2442)



G-18 A
RAPPELLING GLOVES (3-CUT FINGER)

- These highly specialized gloves offer versatility in jobs where multiple tasks are being performed.
- Premium synthetic leather palm and fingertip patches.
- Velcro wrist fastening.
- The fingertips are open on the thumb, index and middle digits. User can switch from one task (like material handling) to another (data entry requiring touch sensitivity) without having to remove gloves.

Standard: EN 388:2003 (2442)



HARNESSES

LANYARDS &
SHOCK ABSORBERS

CARABINERS

PULLEYS

ASCENDERS

DESCENDERS

HELMETS

MOBILE FALL
ARRESTERS

RETRACTABLE
FALL ARRESTERS

RESCUE DEVICES

STRETCHERS

ROPES

BAGS AND
ACCESSORIES

SAFETY NETS

EDGE PROTECTION

TRIPOD AND
CANTILEVER ARMS

ANCHORAGES

HORIZONTAL
LIFELINE

VERTICAL LIFELINE

DEFENCE

LIFTING
EQUIPMENT



BG-05
CARRYING BAG

- Special design for carrying work at height equipment.
- 45 mm polyester shoulder straps.
- Color options: orange and black.

Weight : 693 gr
Dia : 30 cm
Height : 50 cm
Volume: 35 L



BG-07
CARRYING BAG

- Specially designed to carry working at height equipment.
- Shoulder straps for easy carrying.

Weight : 1000 gr
Dia : 30 cm
Height : 50 cm
Volume: 35 L



BG-10
CARRYING BAG

- Made of 1900 denier special fabric.
- Bottom supported with 5 mm foam pad.
- 450 polyester lining.
- Edges are coated with plastic cord.
- Metal transporter buckles.
- Type 8 zipper.
- Carrying straps are made of 45 mm polyester webbing (2900 kg tensile strength).

Weight : 1.330 gr
Width : 65 cm
Length : 30 cm
Height : 30 cm
Volume: 58,5 L



BG-15
CARRYING BAG

- Produced from high tenacity water proof cloth
- Concealable back strap pads
- Additional shoulder strap if needed
- Material space separated with zipper
- Wallet, Passport space

Weight : 1.248 gr
Width : 30 cm
Length : 110 cm
Height : 45 cm
Volume: 58,5 L



HARNESSES

LANYARDS &
SHOCK ABSORBERS

CARABINERS

PULLEYS

ASCENDERS

DESCENDERS

HELMETS

MOBILE FALL
ARRESTERS

RETRACTABLE
FALL ARRESTERS

RESCUE DEVICES

STRETCHERS

ROPES

**BAGS AND
ACCESSORIES**

SAFETY NETS

EDGE PROTECTION

TRIPOD AND
CANTILEVER ARMS

ANCHORAGES

HORIZONTAL
LIFELINE

VERTICAL LIFELINE

DEFENCE

LIFTING
EQUIPMENT



MB-35
MATERIAL CARRYING BAG

- Two large, comfortable carrying handles.
- Adjustable strap for carrying bandolier style.
- Interior ring can be used as attachment point for rope.
- Waterproof fabric.
- Bag remains upright and has an exterior folding lid system that allows easy access to the contents of the bag.

Weight : 1.198 gr
Dia : 30 cm
Height : 54 cm
Volume: 38 L



MB-20

MB-20
MATERIAL CARRYING BAG

- Two large, comfortable carrying handles.
- Adjustable strap for carrying bandolier style.
- Interior ring can be used as attachment point for rope.
- Waterproof fabric.
- Bag remains upright and has an exterior folding lid system that allows easy access to the contents of the bag.

Weight : 805 gr
Dia : 25 cm
Height : 40 cm
Volume: 20 L



MB-10

MB-10
MATERIAL CARRYING BAG

- Two large, comfortable carrying handles.
- Adjustable strap for carrying bandolier style.
- Interior ring can be used as attachment point for rope.
- Waterproof fabric.
- Bag remains upright and has an exterior folding lid system that allows easy access to the contents of the bag.

Weight : 405 gr
Dia : 21 cm
Height : 30 cm
Volume: 10 L



TP-05
TOOL HOLDER

- Suitable for hanging tools while working at height.
- Enables tools to be fixed at safety harness.
- Prevents equipment from falling.

Weight: 86,5 gr



TP-06
TOOL HOLDER

- Attaches easily to the pack's internal loop for organizing gear.
- Bags can be hanged to the loop easily.
- There are four pieces loops.

Weight : 99,5 gr

Length : 57 cm

Loop pcs: 4

HARNESSES

LANYARDS &
SHOCK ABSORBERS

CARABINERS

PULLEYS

ASCENDERS

DESCENDERS

HELMETS

MOBILE FALL
ARRESTERS

RETRACTABLE
FALL ARRESTERS

RESCUE DEVICES

STRETCHERS

ROPES

BAGS AND
ACCESSORIES

SAFETY NETS

EDGE PROTECTION

TRIPOD AND
CANTILEVER ARMS

ANCHORAGES

HORIZONTAL
LIFELINE

VERTICAL LIFELINE

DEFENCE

LIFTING
EQUIPMENT





SN-100
PERSONNEL SAFETY NET

- Ideal for workplace safety, construction site safety, home renovation safety, preventing injury from falling tools, blocking small entrances to unsafe areas, protecting exposed openings in floor, stairs or windows.
- Can be positioned horizontally or vertically.
- UV Resistance.
- Fabricated using polypropylene or polyamide ropes in such a manner that it gives competent cushioning and impact of the fall is absorbed thereby facilitating safety of the person working at the site.
- Can also be supplied with a debris net laced together with safety net, enabling the net to catch any small pieces of debris
- Have high breaking strength that support heavy load impacts and stabilize against adverse atmospheric conditions to ensure longer life.

Product Type: SN-100
Mesh Size : 100x100 mm
Standard : EN 1263-1
Size : Produced as per customer request.
Color : Orange or white
Material : High Tenacity Polypropylene or Polyamide
Rope Dia : 6 mm

HARNESSES

LANYARDS &
SHOCK ABSORBERS

CARABINERS

PULLEYS

ASCENDERS

DESCENDERS

HELMETS

MOBILE FALL
ARRESTERS

RETRACTABLE
FALL ARRESTERS

RESCUE DEVICES

STRETCHERS

ROPES

BAGS AND
ACCESSORIES

SAFETY NETS

EDGE PROTECTION

TRIPOD AND
CANTILEVER ARMS

ANCHORAGES

HORIZONTAL
LIFELINE

VERTICAL LIFELINE

DEFENCE

LIFTING
EQUIPMENT



SNP-46
PERSONNEL SAFETY NET PLATFORM

- These platforms are used on high-rise buildings to protect the workforce and pedestrians on the ground or the facade of the building while work is being carried out overhead.
- Can also be supplied with a debris net laced together with safety net, enabling the net to catch any small pieces of debris.
- Folds up against the facade for easy crane access below or as a safety precaution during bad weather.
- The Safety Net Platform is easily assembled on the ground and lifted into place by crane.
- Can be adjusted to the desired floor height thanks to the its telescopic legs.
- The installation is done using different accessories to suit the building application.
- Long-lasting Long-life durability.

Size : Standard size is: 4x6 mt but it can also be customized as per the precise specifications and demands of the client.

Standard: EN 1263-1

PRODUCT CODE	TYPE	WIDTH (MT)	LENGTH (MT)
SNP-46 Tip 6		4	6
SNP-46 Tip 5		4	5
SNP-46 Tip 4		4	4
SNP-46 Tip 3		4	3
SNP-46 Tip 6P	With Buttress	4	6
SNP-46 Tip 5P	With Buttress	4	5
SNP-46 Tip 4P	With Buttress	4	4
SNP-46 Tip 3P	With Buttress	4	3



SAFETY NET APPLICATION FOR WIDE FLOOR OPENINGS



SAFETY NET APPLICATION FOR ELEVATOR SHAFT



SAFETY NET APPLICATION FOR ROOF CHANGING AT FACTORY

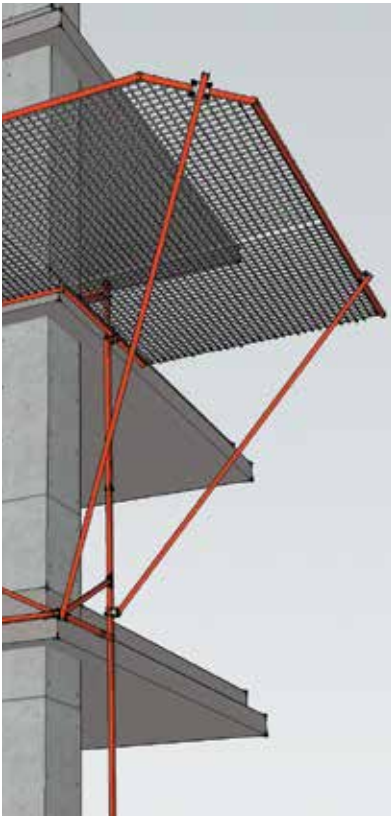

SAFETY NET PLATFORM APPLICATIONS AT BUILDING EDGES



SAFETY NET APPLICATION FOR BUILDING ENTRANCES



SAFETY NET PLATFORM APPLICATIONS FOR FACADES

HARNESSES

LANYARDS & SHOCK ABSORBERS

CARABINERS

PULLEYS

ASCENDERS

DESCENDERS

HELMETS

MOBILE FALL ARRESTERS

RETRACTABLE FALL ARRESTERS

RESCUE DEVICES

STRETCHERS

ROPES

BAGS AND ACCESSORIES

SAFETY NETS

EDGE PROTECTION

TRIPOD AND CANTILEVER ARMS

ANCHORAGES

HORIZONTAL LIFELINE

VERTICAL LIFELINE

DEFENCE

LIFTING EQUIPMENT

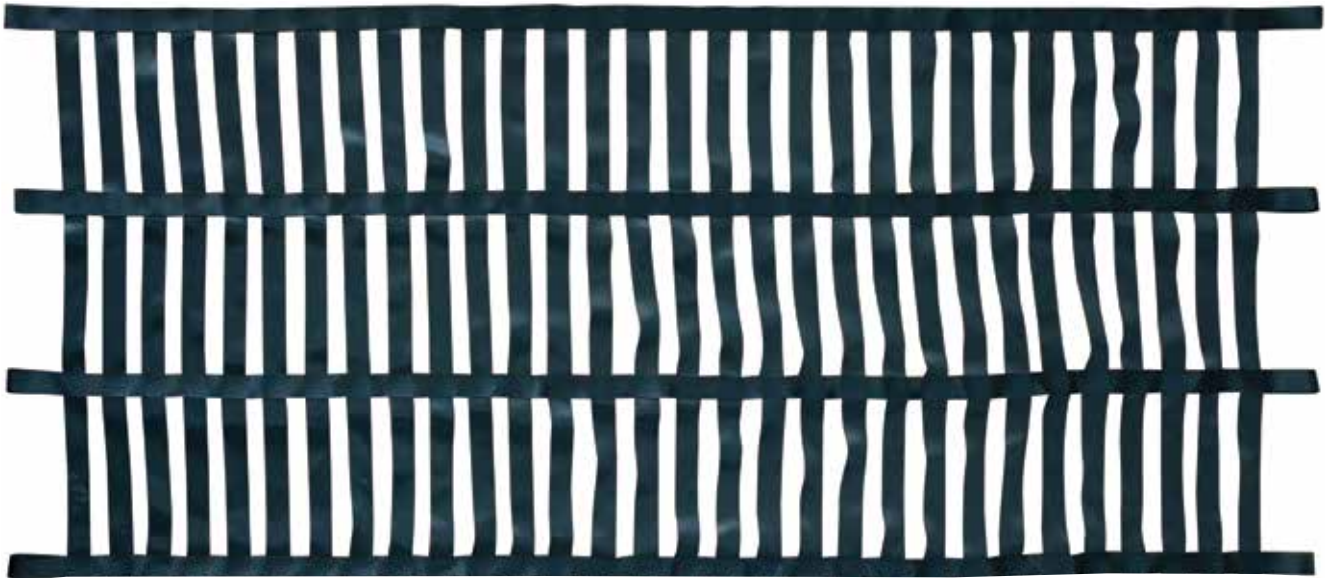

SS-100 **SNOW FENCE**

- Made of high tenacity polyester webbing.
- Webbing is stitched by bonded type sewing yarn in CNC machines.
- UV resistant.
- Eyelets on webbing ends for easy assembly.



SS-110
AVALANCHE BARRIER

Avalanche Barriers are flexible metal structures acting to prevent avalanches from starting. Avalanche barriers are consisting of steel tubular post and wire rope anchors. The Avalanche Barriers are commonly installed in numerous lines in the avalanche starting zones; as the snow accumulates the avalanche barriers retain the accumulated snow pack, preventing the initiation of an avalanche. The avalanche barriers are available in various sizes and snow load capacities dependent on site conditions.

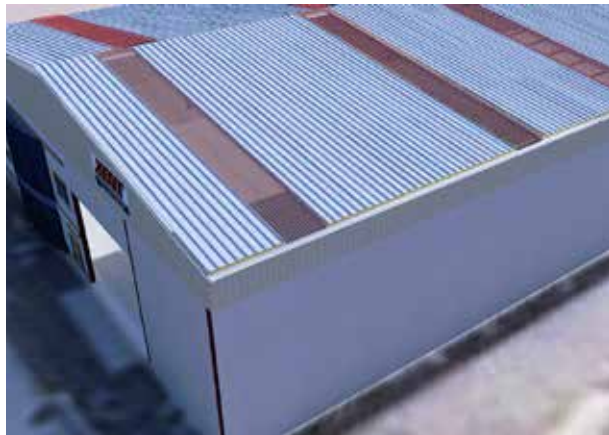
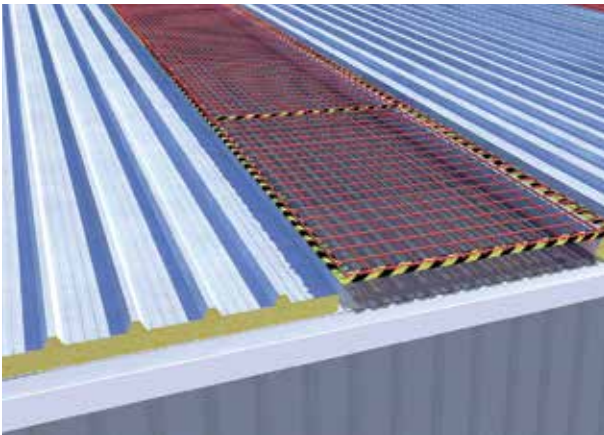

ROLP-100
ROOF LIGHTING FENCE

- Designed for roofs made of polycarbonate roofing sheets, or sandwich panels.
- Provides safety net against falls during initial roof installation or maintenance work.

Wire Dia : 6 mm
Mesh Size: 5cm x 20cm
Width : 110 cm
Length : 250 cm

Models;
ROLP-100 Flat Roof Protection
ROLP-110 Framed Flat Roof Protection
ROLP-130 Gable Roof Protection

HARNESSES

LANYARDS &
SHOCK ABSORBERS

CARABINERS

PULLEYS

ASCENDERS

DESCENDERS

HELMETS

MOBILE FALL
ARRESTERS

RETRACTABLE
FALL ARRESTERS

RESCUE DEVICES

STRETCHERS

ROPES

BAGS AND
ACCESSORIES

SAFETY NETS

EDGE PROTECTION

TRIPOD AND
CANTILEVER ARMS

ANCHORAGES

HORIZONTAL
LIFELINE

VERTICAL LIFELINE

DEFENCE

LIFTING
EQUIPMENT



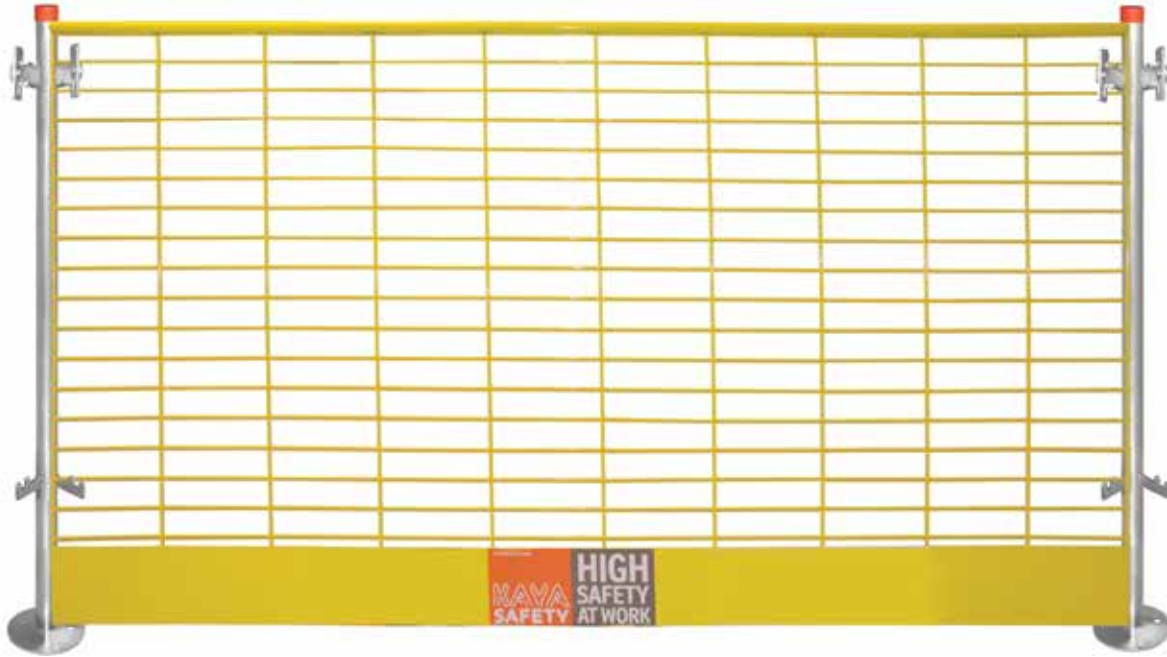

KK-200G
EDGE PROTECTION SYSTEM

- Designed to cover all edge protection risks that may arise at the beginning of construction work.
- Shipped in a box that is specially designed for ergonomic transportation and loading of the main frame and its components.
- The posts are easily mounted with a single screw. In this way, the installation time is shortened and the same connection element is used again and again so gained cost advantage.
- The posts elements have two connection points at the top and bottom.
- The posts elements can be combined with the traditional binarization method, if desired, combined with the end-to-end insertion method. Since there will be no loss of quantity in total, the amount of product used decreases and so the costs.
- It is enough to use one post in corner turns. Like the classic systems, there is no need to continue with a new post afterwards. No need pay extra for an additional post.
- The Body elements are yellow color electrostatic powder painted.
- There are various types of warning plates on the surface facing toward skirting part of the building. If desired, the company logo can be added to this section.
- Mesh size is 5 cm x 20 cm thus preventing feet entering cells.
- Diameter of the wire is 6 mm.

Standartd: TS EN 13374:2013 (Temporary edge protection systems - Product specification - Test methods)

Components;

KK-200G
Height : 110 cm
Length: 200 cm
Weight: 12,00 kg

KK-100G
Height: 110 cm
Length: 100 cm
Weight: 6,00 kg

KK-110D
Height: 110 cm
Length: 100 cm
Weight: 3,70 kg

HARNESSES

LANYARDS &
SHOCK ABSORBERS

CARABINERS

PULLEYS

ASCENDERS

DESCENDERS

HELMETS

MOBILE FALL
ARRESTERS

RETRACTABLE
FALL ARRESTERS

RESCUE DEVICES

STRETCHERS

ROPES

BAGS AND
ACCESSORIES

SAFETY NETS

EDGE PROTECTION

TRIPOD AND
CANTILEVER ARMS

ANCHORAGES

HORIZONTAL
LIFELINE

VERTICAL LIFELINE

DEFENCE

LIFTING
EQUIPMENT



Special design double locking system is compatible with the traditional binarization method as well as the end-to-end insertion method.

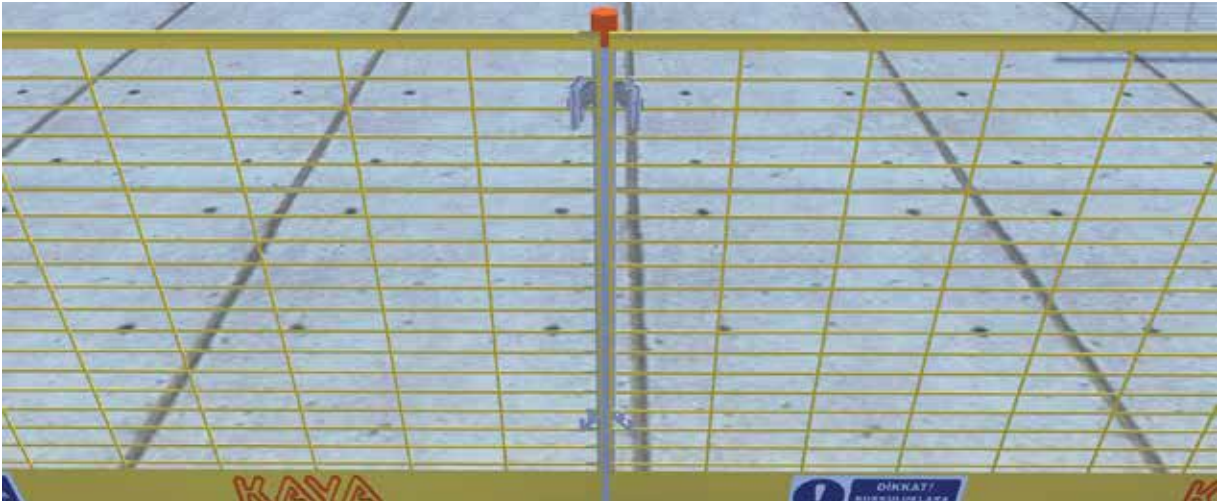

The Body elements can be combined with the end-to-end insertion method. Since there will be no loss of quantity in total, the amount of product used decreases and so the costs.

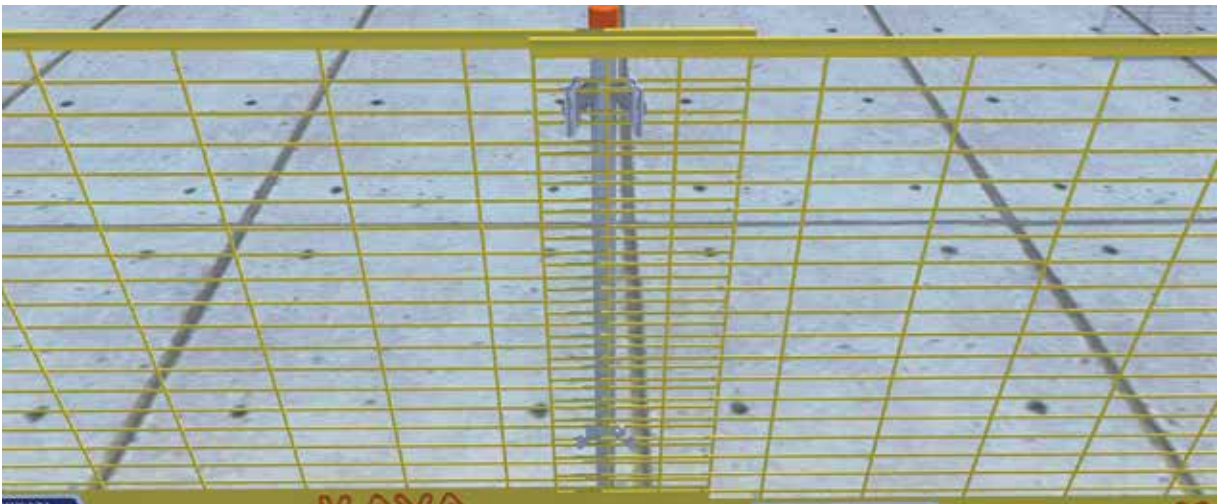

The Body elements can be combined with the traditional binarization method thanks to special design double locking system of posts elements.

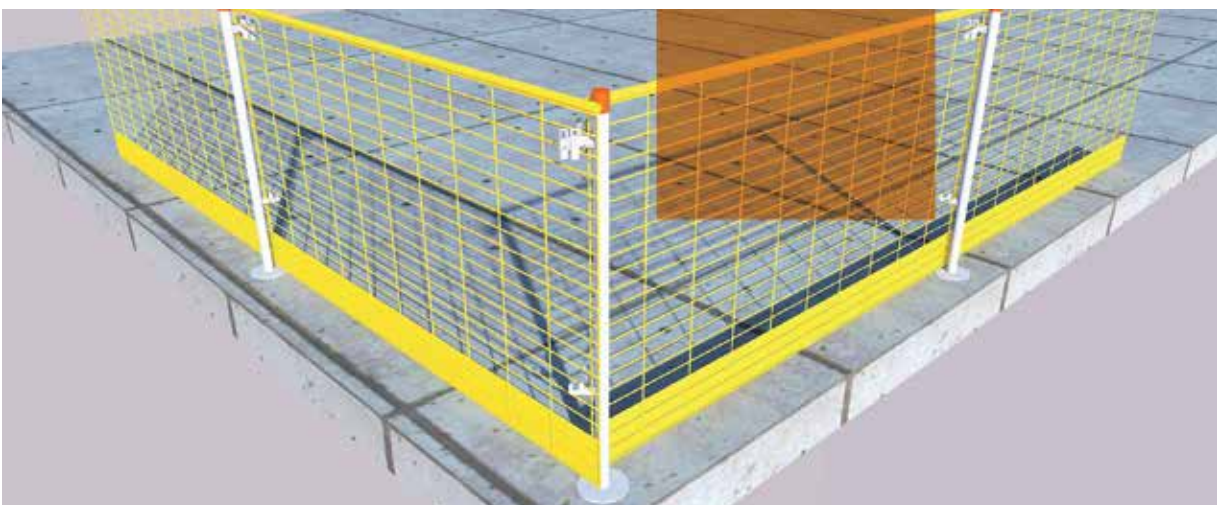

It is enough to use one post in corner turns. Like the classic systems, there is no need to continue with a new post afterwards. No need pay extra for an additional post.

HARNESSES

LANYARDS &
SHOCK ABSORBERS

CARABINERS

PULLEYS

ASCENDERS

DESCENDERS

HELMETS

MOBILE FALL
ARRESTERS

RETRACTABLE
FALL ARRESTERS

RESCUE DEVICES

STRETCHERS

ROPES

BAGS AND
ACCESSORIES

SAFETY NETS

EDGE PROTECTION

TRIPOD AND
CANTILEVER ARMS

ANCHORAGES

HORIZONTAL
LIFELINE

VERTICAL LIFELINE

DEFENCE

LIFTING
EQUIPMENT





SENTOR BRIDGE SYSTEM



SENTOR MONOPOD



SENTOR TWINPOD



SENTOR TRIPOD



SENTOR QUADRIPOD

SENTOR

SENTOR has multifunctional, modular and innovative design. The system is based on simplicity, lightness and robustness as the principle of development. It is very easy to adapt to different workspaces (such as Rescue, Rope Access, Manhole, Silos etc.)



TECHNO ARM



TECHNO ARM MOBILE LEG SET



AASS-1



AASS-2



AASS-3



AASS-4



AASS-M



AASS-MV

CANTILEVER ARMS

Portable and permanent cantilever arms are essential part of a confined space access or rescue plan and provide a fixed anchorage point for work winches or rescue systems for entering confined spaces. Portable design allows for easy transport and storage. Adjustable legs enable them to fit most confined space entry.

HARNESSES

LANYARDS & SHOCK ABSORBERS

CARABINERS

PULLEYS

ASCENDERS

DESCENDERS

HELMETS

MOBILE FALL ARRESTERS

RETRACTABLE FALL ARRESTERS

RESCUE DEVICES

STRETCHERS

ROPES

BAGS AND ACCESSORIES

SAFETY NETS

EDGE PROTECTION

TRIPOD AND CANTILEVER ARMS

ANCHORAGES

HORIZONTAL LIFELINE

VERTICAL LIFELINE

DEFENCE

LIFTING EQUIPMENT

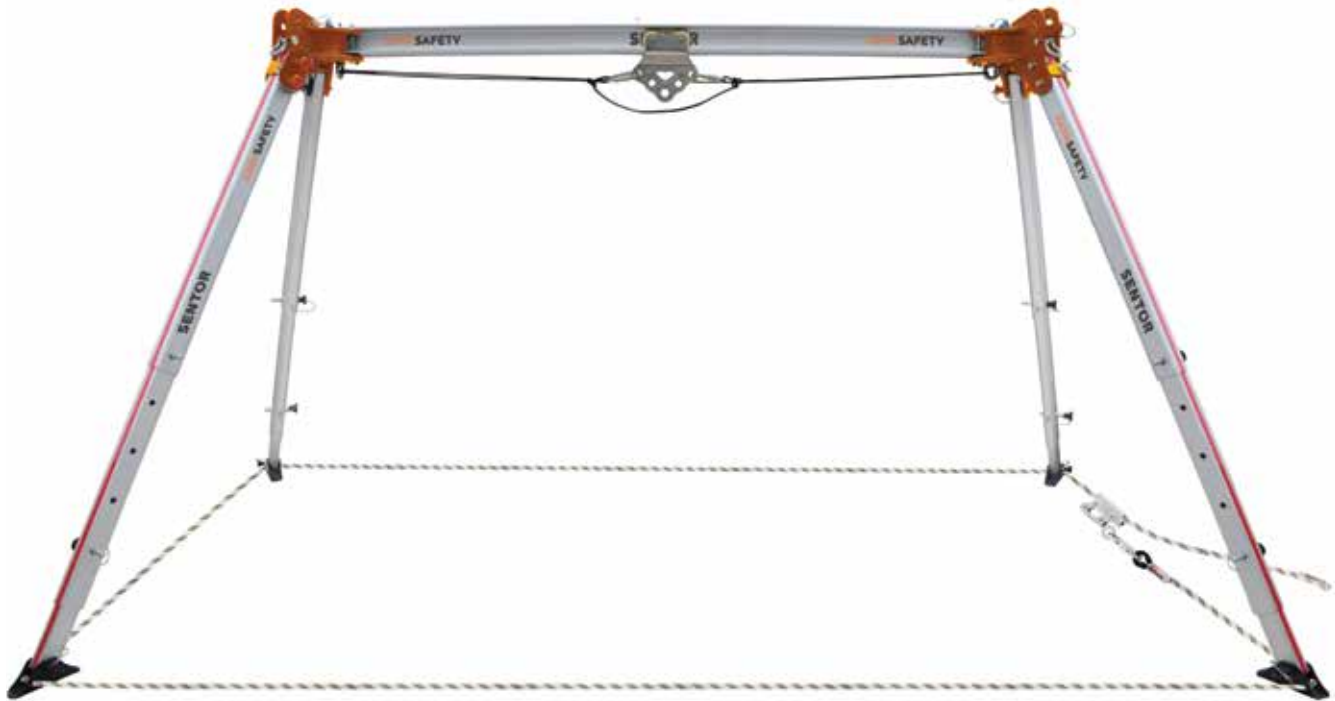

SENTOR SENTOR BRIDGE SYSTEM

- SENTOR has multifunctional, modular and innovative design. The system is based on simplicity, lightness and robustness as the principle of development.
- It is very easy to adapt to different workspaces (such as Rescue, Rope Access, Manhole, Silos etc.)
- SENTOR can be constructed into many different configurations including;
 - Monopod
 - Twinpod
 - Tripod
 - Quadripod
 - Quadripod Bridge System
- Tested and certified for the use of 2 people and 300 kg working and rescue load.
- The system has a main head with unique design made from high-alloy aluminum material. Four legs can be attached and detached depending on the type of slots on this head.
- The telescopic legs can easily be attached to the head with the help of a pin to achieve the desired structure.
- Telescopic legs have anchor points in their heads. Thanks to these anchoring points, the system can be fixed at different points with the help of rope.
- The telescopic legs can be fastened and removed with the help of a single pin. If needed during use, the position of the roller can be quickly mounted on the other legs. The pulley is made of stainless steel material.
- There are two different slots on the pulley. These slots can be operated with rope systems up to Ø 13 mm and steel wire ropes systems with up to 8 mm.

Standard: EN 795:2012 Type B & CEN TS 16415:2013 Type B

	Closed	Open
Height (H)	: 134 cm	275 cm
Length of the Leg (L)	: 160 cm	314 cm
Ground Area (1.5 mt Bridge System):	226 x 117 cm	300 x 246 cm
Ground Area (2.0 mt Bridge System):	276 x 117 cm	355 x 246 cm
Ground Area (3.0 mt Bridge System):	326 x 117 cm	455 x 246 cm



SENTOR HEAD



MULTIPLE ANCHOR SLIDER



SENTOR PULLEY



SENTOR HRA BRACKET



SENTOR ALKO WINCH BRACKET



SENTOR BRIDGE



SENTOR MONOPOD

SENTOR CONFIGURATIONS

SENTOR CONFIGURATIONS					
COMPONENT	MONOPOD	TWINPOD	TRIPOD	QUADRIPOD	QUADRIPOD BRIDGE
TELESCOPIC LEG	1	2	3	4	4
SENTOR PULLEY	1	1	1 + Optional	1 + Optional	2
SENTOR HEAD	-	1	1	2	2
BRIDGE RAIL	-	1	1	2	1 (2 meter)
MULTIPLE ANCHOR SLIDER	-	-	-	-	-
HRA MOUNTING BRACKET	Optional	Optional	Optional	Optional	Optional
ALKO WINCH MOUNTING BRACKET	Optional	Optional	Optional	Optional	Optional
WHEEL LEG	-	-	Optional	Optional	Optional
NAIL LEG	-	-	Optional	Optional	Optional
SAFETY ROPE	-	1	1	1	1

HARNESSES

LANYARDS &
SHOCK ABSORBERS

CARABINERS

PULLEYS

ASCENDERS

DESCENDERS

HELMETS

MOBILE FALL
ARRESTERS

RETRACTABLE
FALL ARRESTERS

RESCUE DEVICES

STRETCHERS

ROPES

BAGS AND
ACCESSORIES

SAFETY NETS

EDGE PROTECTION

TRIPOD AND
CANTILEVER
ARMS

ANCHORAGES

HORIZONTAL
LIFELINE

VERTICAL LIFELINE

DEFENCE

LIFTING
EQUIPMENT

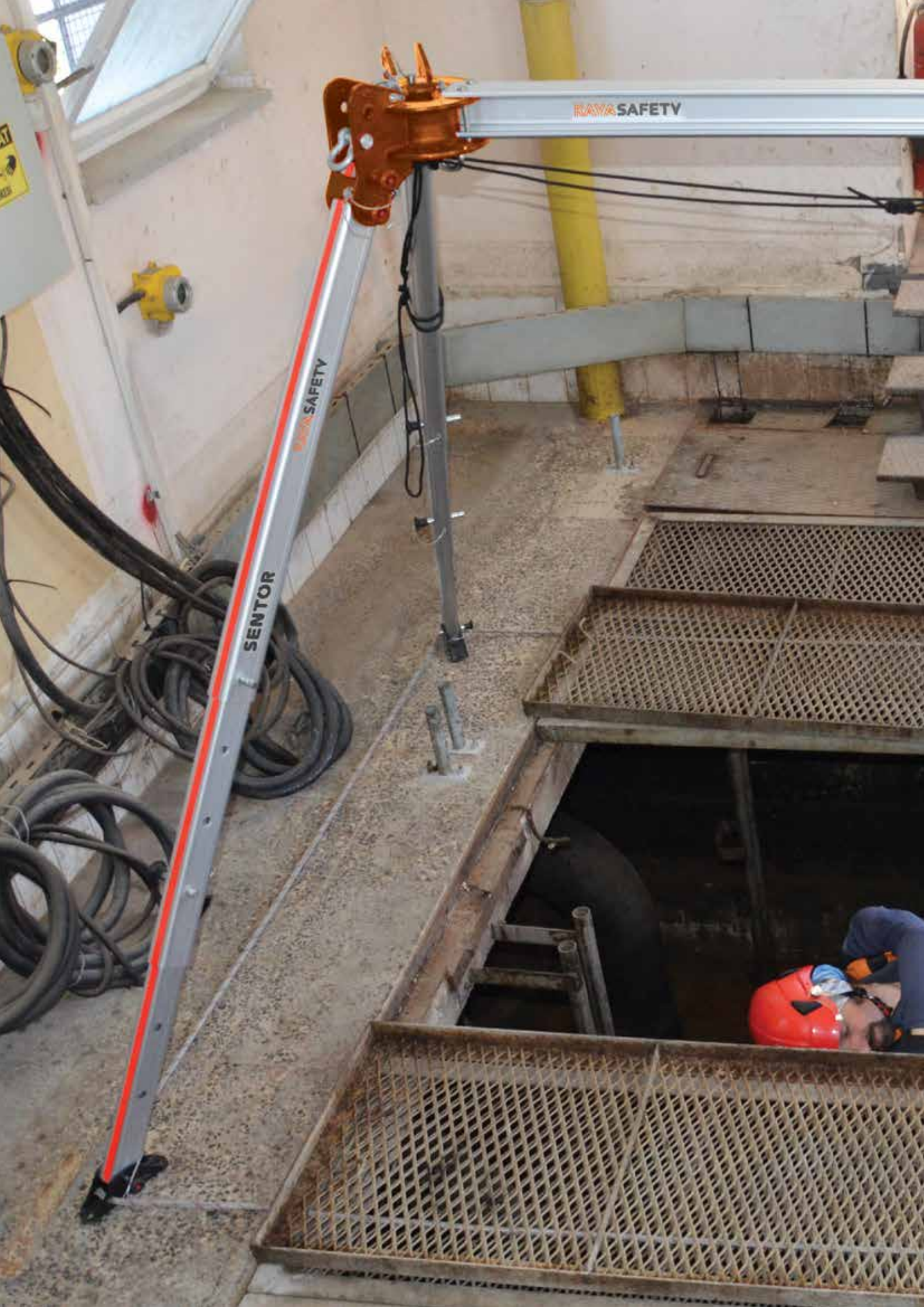

RAYA SAFETY

SENTOR





SENTOR
SENTOR MONOPOD

- It is an ideal system for situations where there is not enough room to retrieve a rescue stretcher or person, over an edge.
- Compatible with Hand Winch or Retractable Fall Arrester Block.
- The system can be used by fixing it from different points with the help of the eyebolt in the head.

	Closed	Open
Length of the leg (L):	160 cm	314 cm



SENTOR
SENTOR TWINPOD

- The system can be easily created with two telescopic leg and main head.
- The main head and fastening eyebolts are used for safe positioning.
- You can also create this system by removing a leg from the tripod.
- This configuration is recommended to be used in places where only two legs of the tripod can be fixed on ground such as cliffs, high-rise buildings and bridges.

	Closed	Open
Height (H)	: 122 cm	275 cm
Length of the leg (L) :	160 cm	314 cm





SENTOR SENTOR TRIPOD

- This configuration is a self-supporting anchor point.
- It provides quick and easy access to narrow areas such as manholes.
- In this configuration, HRA Retractable Fall Arrester and Hand Winch can be connected the tripod. In addition, the product perfectly matches all technical applications that can be installed with a rope.

	Closed	Open
Height (H)	: 122 cm	275 cm
Length of the leg (L)	: 160 cm	314 cm
Ground Dia (Ø)	: 145 cm	294 cm

SENTOR SENTOR QUADRIPOD

- This configuration is a self-supporting anchor point.
- It is a 33% stronger system than Tripod.
- For this reason, it may be preferable to critical recovery and applications where sudden loads can occur.
- This product can also be used as TRIPOD, MONOPOD, TWINPOD.

	Closed	Open
Height (H)	: 122 cm	275 cm
Length of the leg (L)	: 160 cm	314 cm
Ground Dia (Ø)	: 145 cm	295 cm



HARNESSES

LANYARDS &
SHOCK ABSORBERS

CARABINERS

PULLEYS

ASCENDERS

DESCENDERS

HELMETS

MOBILE FALL
ARRESTERS

RETRACTABLE
FALL ARRESTERS

RESCUE DEVICES

STRETCHERS

ROPES

BAGS AND
ACCESSORIES

SAFETY NETS

EDGE PROTECTION

TRIPOD AND
CANTILEVER
ARMS

ANCHORAGES

HORIZONTAL
LIFELINE

VERTICAL LIFELINE

DEFENCE

LIFTING
EQUIPMENT



GIRAF 360 3.1 R



GIRAF 360 4.0

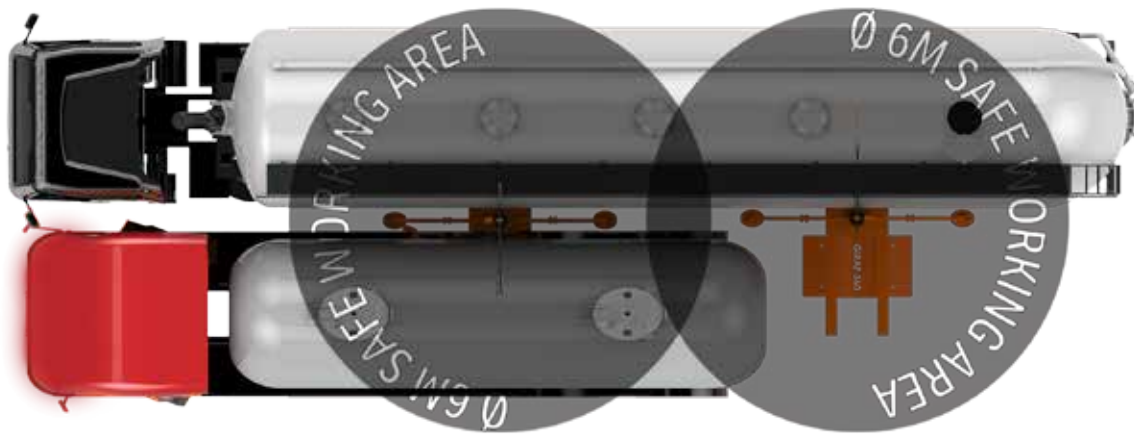

GIRAF 360

MOBILE OVERHEAD LOADING PLATFORM

- GIRAF has an innovative design.
- The anchor point can be created at any place where truck is parked.
- Truck Loading / Unloading is now safer with the GIRAF 360.
- Thanks to its 360-degree rotation feature, it can be used in two vehicles parked side by side.
- No balance weight is required for installation.
- Has active shock absorber system.
- Has a telescopic body and can be installed quickly by means of a forklift which can be raised by at least 3 m.
- Max Height is 7.1 meters.
- Can be used with more than one type of leg depending on working area.
- For 1 person use.

Standard: EN 795:2012 Type B

Product Types;

GRF - 2.2 R Mobile 360 Universal Working Platform (2 legs and 2 pcs ramp supported)

GRF - 3.1 R Mobil 360 Universal Working Platform (3 legs and 1 pcs ramp supported)

GRF - 3.1 Mobil 360 Universal Working Platform (3 legs)

GRF - 2.2 Mobil 360 Universal Working Platform (2 legs)

GRF - 4.0 Mobil 360 Universal Working Platform (4 legs)

HARNESSES

LANYARDS &
SHOCK ABSORBERS

CARABINERS

PULLEYS

ASCENDERS

DESCENDERS

HELMETS

MOBILE FALL
ARRESTERS

RETRACTABLE
FALL ARRESTERS

RESCUE DEVICES

STRETCHERS

ROPES

BAGS AND
ACCESSORIES

SAFETY NETS

EDGE PROTECTION

TRIPOD AND
CANTILEVER
ARMS

ANCHORAGES

HORIZONTAL
LIFELINE

VERTICAL LIFELINE

DEFENCE

LIFTING
EQUIPMENT



TECHNO ARM

CANTILEVER ARMS

- Designed to be used as fall arrest and rescue system when working in manholes, platforms, silos, roof edges etc.
 - Made of aluminum alloy material. It is light weight. Transportation and installation can be performed by one person.
 - It has 360-degree rotatable console body. Can be fixed when requested. The console posts have two different sizes (60 and 130 cm) for different working heights.
 - The cantilever can be adjusted in eight different positions in accordance with the required angle, position and height. Switching in positions is easily accomplished by changing the pin position.
 - It has more than one ground sleeve for different working areas.
 - Retractable Fall Arrester with Recovery Arm and / or Hand Winch can be mounted on anchorage body.
- * Certified with 3 independent anchor points with a 100 Kg dynamic load. Maximum SWL is 300 Kg for static loads.

Note: If you do not specify the bracket size at the order, it is shipped with 130 cm bracket.

Weight: 26,70 kg (with 60 cm post)
30,80 kg (with 130 cm post)

Standard: EN 795:2012 Type B, CEN/TS 16415:2013 Type B



TECHNO ARM



CONSOLE POSTS



CP-30
GROUND MOUNTING SLEEVE
TECHNO ARM POSTS



WP-30
WALL MOUNTING SLEEVE



WCP-30
EDGE MOUNTING SLEEVE



BP-30
CONCRETE MOUNTING SLEEVE



MP-100
MOBILE LEG
TECHNO ARM POSTS



RB-30
HRA MOUNTING BRACKET
HRA & ALKO BRACKET



AB-30
ALKO WINCH MOUNTING BRACKET

HARNESSES

LANYARDS &
SHOCK ABSORBERS

CARABINERS

PULLEYS

ASCENDERS

DESCENDERS

HELMETS

MOBILE FALL
ARRESTERS

RETRACTABLE
FALL ARRESTERS

RESCUE DEVICES

STRETCHERS

ROPES

BAGS AND
ACCESSORIES

SAFETY NETS

EDGE PROTECTION

TRIPOD AND
CANTILEVER
ARMS

ANCHORAGES

HORIZONTAL
LIFELINE

VERTICAL LIFELINE

DEFENCE

LIFTING
EQUIPMENT



TECHNO ARM POSTS

- Made of high quality aluminum alloy material.
- Has connection slot for retractable fall arrester or hand winch.

Sizes and Weights

- TAB - 060 – 60 cm (3,50 kg)
- TAB - 130 – 130 cm (7,60 kg)

Standard: EN 795:2012 Type B,
CEN/TS 16415:2013 Type B

MP-100

MOBILE LEG

- Mobile and portable.
- Telescopic legs can be expanded in 2 stages and adjusted easily with a single pin.
- Made of lightweight aluminum alloy material.
- It has high corrosion resistance thanks to anodic coating.

Sizes;

- Telescopic legs when closed
Width: 1237 mm, **Length:** 1673 mm, **Dia:** 1600 mm
- Telescopic legs when opened
Width: 1637 mm, **Length:** 1673 mm, **Dia:** 2000 mm

Weight : 39,00 kg

Standard: EN 795:2012 Tip B, CEN/TS 16415:2013 Tip B



CP-30



WP-30



RB-30



WCP-30



BP-30



AB-30

CP-30
GROUND MOUNTING SLEEVE

- Can be installed on concrete or steel ground.
- Made of Steel.

Height: 30 cm
Weight: 12,30 kg

WCP-30
EDGE MOUNTING SLEEVE

- Can be installed 90-180 degree angular walls.
- Made of Steel.

Height: 30 cm
Weight: 10,00 kg

WP-30
WALL MOUNTING SLEEVE

- Can be installed on concrete or steel wall.
- Made of Steel.

Height: 30 cm
Weight: 8,50 kg

BP-30
LOWER GROUND MOUNTING SLEEVE

- It is assembled by casting with concrete.
- Made of Steel.

Height: 30 cm
Weight: 5,80 kg

RB-30
HRA MOUNTING BRACKET

- Made of Stainless Steel.

Weight: 2,40 kg

AB-30
ALKO WINCH MOUNTING BRACKET

- Made of Stainless Steel.

Weight: 2,30 kg

HARNESSES

LANYARDS & SHOCK ABSORBERS

CARABINERS

PULLEYS

ASCENDERS

DESCENDERS

HELMETS

MOBILE FALL ARRESTERS

RETRACTABLE FALL ARRESTERS

RESCUE DEVICES

STRETCHERS

ROPES

BAGS AND ACCESSORIES

SAFETY NETS

EDGE PROTECTION

TRIPOD AND CANTILEVER ARMS

ANCHORAGES

HORIZONTAL LIFELINE

VERTICAL LIFELINE

DEFENCE

LIFTING EQUIPMENT



TECHNO ARM FIXED SET

- TA-130 (Techno Arm Body 130 cm).
- CP-30 Ground Mounting Sleeve.
- RB-30 HRA Mounting Bracket.
- HRA-24 Retractable Fall Arrester with Recovery Mechanism.
- AB-30 ALKO 901 Mounting Bracket.
- ALKO 901 Load Winch.



TECHNO ARM MOBILE SET

- TA-130 (Techno Arm Body 130 cm).
- NP-100 Mobile Leg.
- RB-30 HRA Mounting Bracket.
- HRA-24 Retractable Fall Arrester with Recovery Mechanism.
- AB-30 ALKO 901 Mounting Bracket.
- ALKO 901 Load Winch.

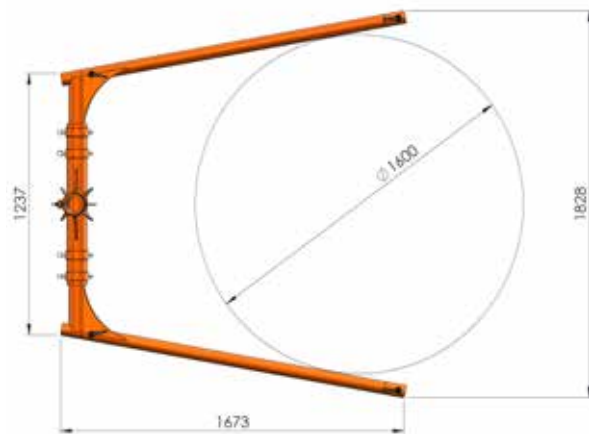
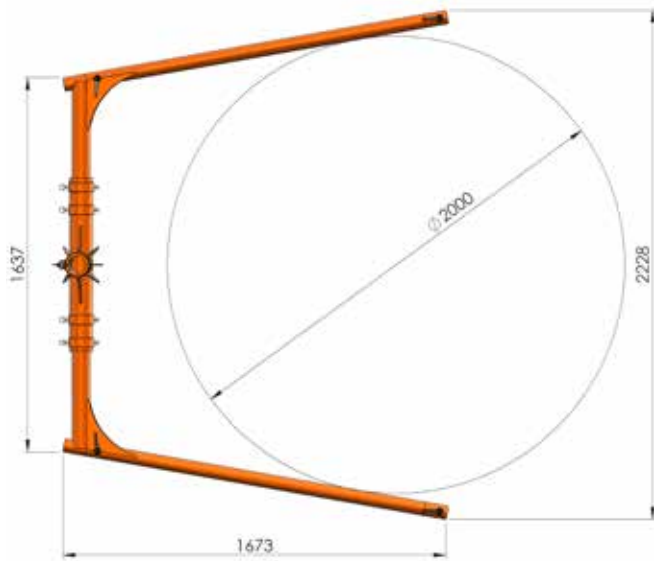

TECHNO ARM MOBILE LEG DIMENSIONS



Min Working Distance: 428 mm



Max Working Distance: 1036 mm



Min Height: 1243 mm

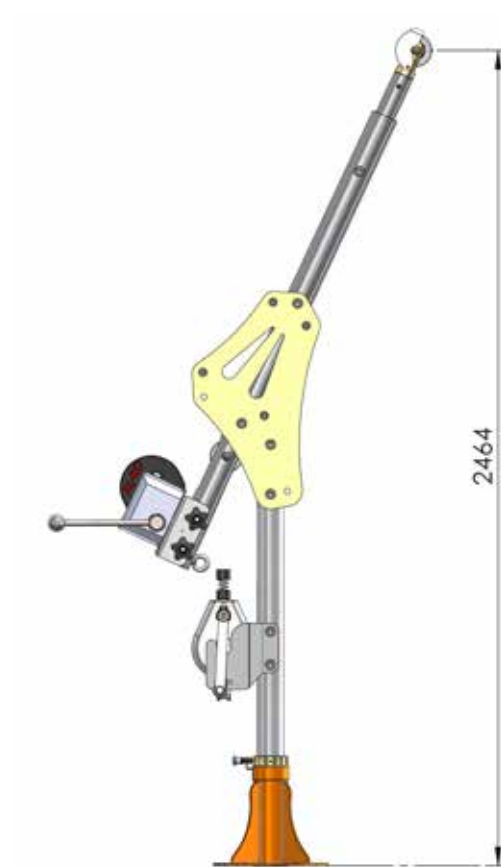

Max Height: 2464 mm

TECHNO ARM DIMENSIONS (WIDTH & HEIGHT)

HARNESSES

LANYARDS & SHOCK ABSORBERS

CARABINERS

PULLEYS

ASCENDERS

DESCENDERS

HELMETS

MOBILE FALL ARRESTERS

RETRACTABLE FALL ARRESTERS

RESCUE DEVICES

STRETCHERS

ROPES

BAGS AND ACCESSORIES

SAFETY NETS

EDGE PROTECTION

TRIPOD AND CANTILEVER ARMS

ANCHORAGES

HORIZONTAL LIFELINE

VERTICAL LIFELINE

DEFENCE

LIFTING EQUIPMENT



IKAR AASS-1



IKAR AASS-2



IKAR AASS-3



IKAR AASS-4



IKAR AASS-M



IKAR AASS-MW



IKAR CANTILEVER ARMS

- Specially developed for stationary use in safety and rescue cases for two persons as well as for lifting and lowering loads.
- Variable fastenings via ground and wall sleeve.
- Suitable for fast relocation.
- Can be used with HRA rescue devices.
- Stable thanks to solid construction, high quality.
- Can be equipped with accessories.

Standard: EN 795:1996/Class B:2012



ALKO-901

LOAD WINCH

- Wire Rope Dia: 6 mm
- Length: 20 meter
- Safe Working Load (SWL): 250 kg

Weight: 7 kg

Note: This device is load winch and so must not be used as personal protective equipment.



41-54/A 9,5–24
HRA MOUNTING BRACKET FOR MAIN FRAME

AASS-1, AASS-2, AASS-3, AASS-4, AASS-M ve AASS-MW



41-54/AL 9,5–24
HRA MOUNTING BRACKET FOR ARM

AASS-1 ve AASS-3



41-54/AWS
ALKO 901
LOAD WINCH BRACKET FOR ARM

AASS-1 ve AASS-3



41-57/1
GROUND SLEEVE

Weight: 12 kg



41-57/2
WALL SLEEVE

Weight: 12 kg



41-57/3
LOWER GROUND SLEEVE

Weight: 12 kg



41-57/3
LOWER GROUND SLEEVE

Weight: 4,6 kg



HARNESSES

LANYARDS & SHOCK ABSORBERS

CARABINERS

PULLEYS

ASCENDERS

DESCENDERS

HELMETS

MOBILE FALL ARRESTERS

RETRACTABLE FALL ARRESTERS

RESCUE DEVICES

STRETCHERS

ROPES

BAGS AND ACCESSORIES

SAFETY NETS

EDGE PROTECTION

TRIPOD AND CANTILEVER ARMS

ANCHORAGES

HORIZONTAL LIFELINE

VERTICAL LIFELINE

DEFENCE

LIFTING EQUIPMENT

CANTILEVER ARMS DIMENSIONS

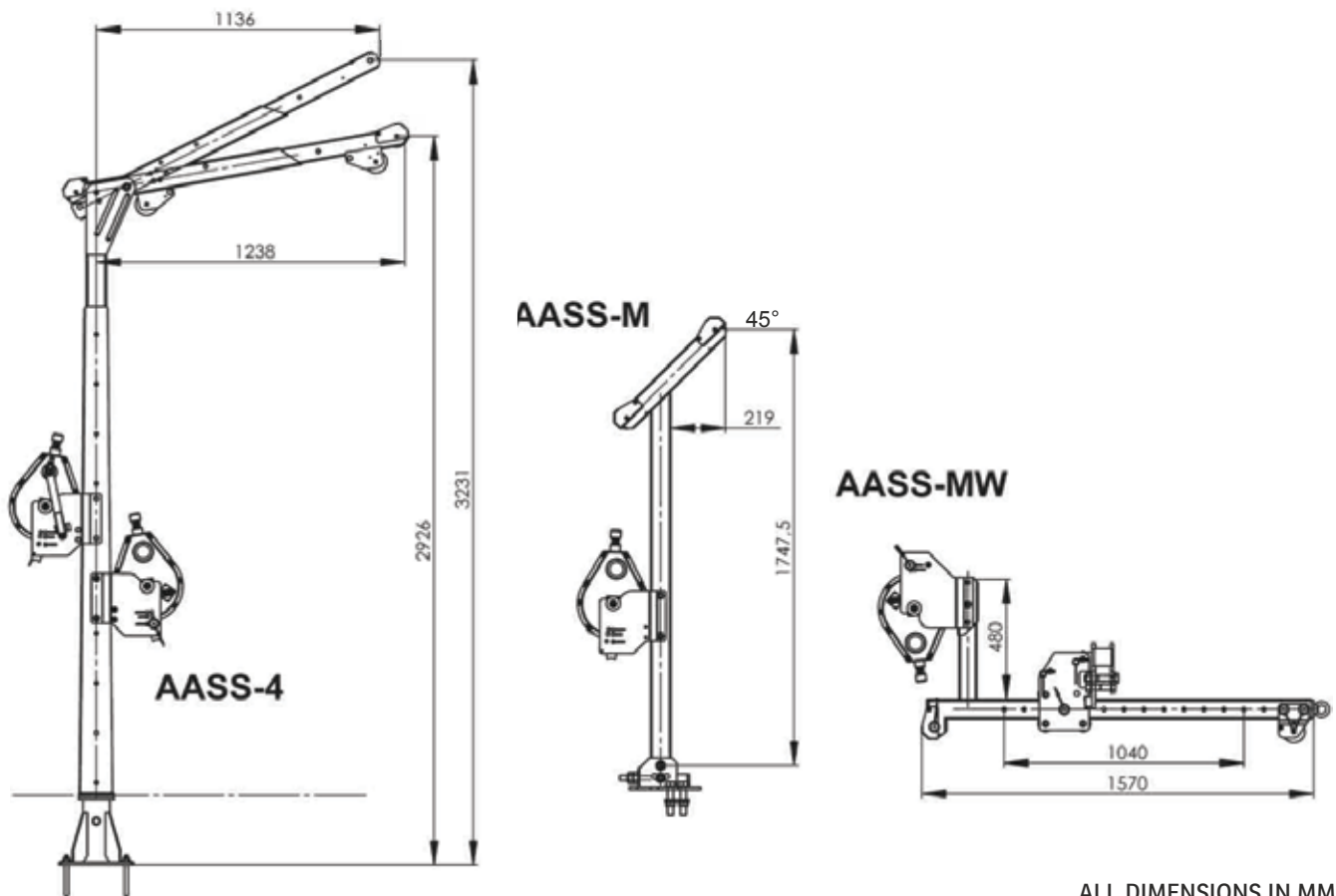
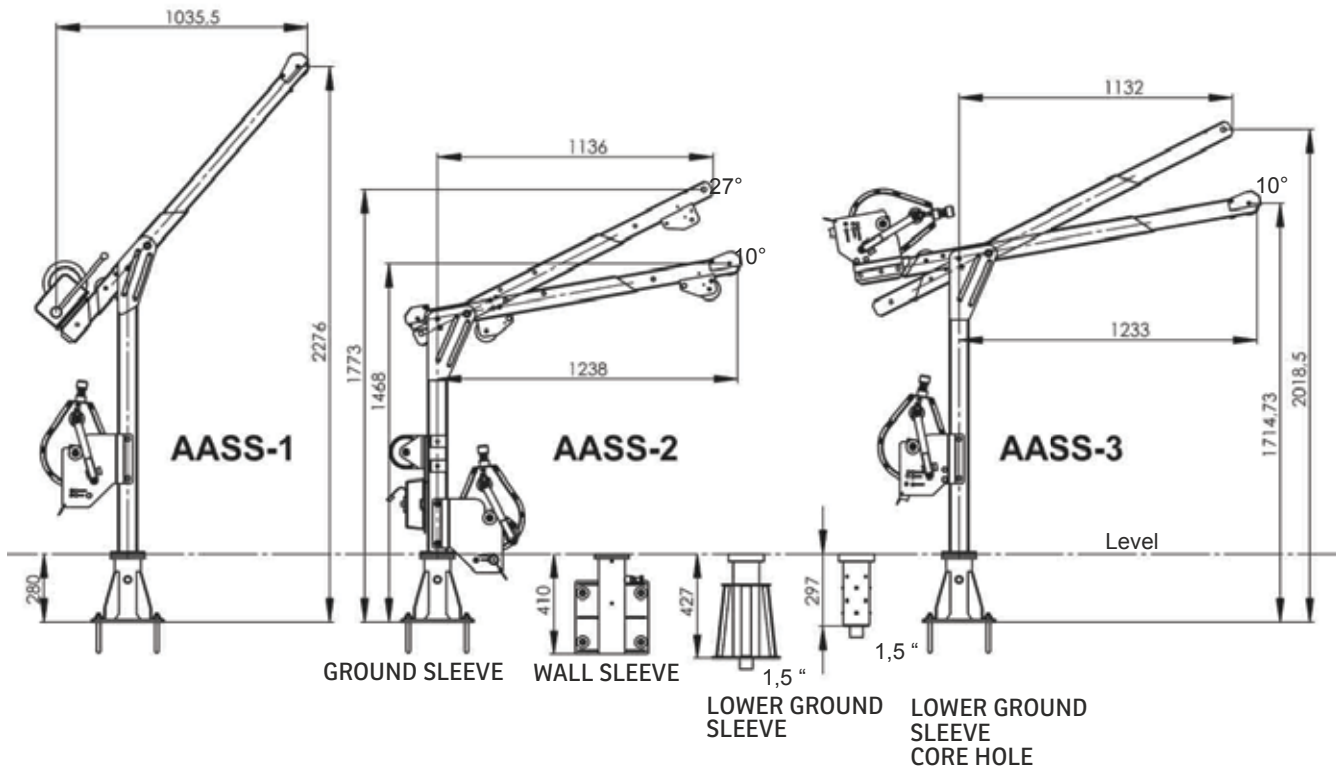

ALL DIMENSIONS IN MM

CANTILEVER ARMS VARIANTS

PRODUCT CODE	PRODUCT NAME	MATERIAL	WEIGHT
41-57	CANTILEVER ARM AASS-1	STAINLESS STEEL	36 KG
41-59	CANTILEVER ARM AASS-2	STAINLESS STEEL	39 KG
41-60	CANTILEVER ARM AASS-3	STAINLESS STEEL	42 KG
41-62	CANTILEVER ARM AASS-4	STAINLESS STEEL	92 KG
41-58	CANTILEVER ARM AASS-M (MENHOLE-CONFINED SPACE)	STAINLESS STEEL	37 KG
41-55	CANTILEVER ARM AASS-MW (MENHOLE-CONFINED SPACE)	STAINLESS STEEL	42 KG

BASE PLATES VARIANTS

PRODUCT CODE	PRODUCT NAME	MATERIAL	WEIGHT
41-57/1	GROUND SLEEVE	STAINLESS STEEL	12 KG
41-57/2	WALL SLEEVE	STAINLESS STEEL	12 KG
41-57/3	LOWER GROUND SLEEVE	STAINLESS STEEL	12 KG
41-57/5	LOWER GROUND SLEEVE	STAINLESS STEEL	4,6 KG

HAND WINCH VARIANTS

PRODUCT CODE	PRODUCT NAME	TYPE	WEIGHT
41-Z7	ALKO 901 HAND WINCH	WORKING LOAD 300 KG	7 KG

HRA MOUNTING BRACKETS

	AASS-1 BODY	AASS-1 ARM	AASS-2 BODY	AASS-3 BODY	AASS-2 ARM	AASS-4 BODY		
HRA (Mt)	ARTICLE NO						MATERIAL	WEIGHT (kg)
9,5 – 24 Mt	41-54/A9,5-24	41-54/AL9,5-24	41-54/A9,5-24	41-54/A9,5-24	41-54/AL9,5-24	41-54/A9,5-24	STAINLESS STEEL	3,5
33 – 42 Mt	41-54/A933-42	41-54/AL33-42	41-54/A933-42	41-54/A933-42	41-54/AL33-42	41-54/A933-42	STAINLESS STEEL	5
50 – 65 Mt	41-54/A50-65	41-54/AL50-65	41-54/A50-65	41-54/A50-65	41-54/AL50-65	41-54/A50-65	STAINLESS STEEL	6





TURTLE

DEADWEIGHT ANCHOR

Turtle is a mobile anchor point designed for use on roofs where rooftop cannot be penetrated.



F-6 F-7 WS-08

ANCHORAGE SLINGS

Slings are designed to form anchor points around suitable structures such as steel work where carabiner gates are not large enough to attach around the large sections.



F-9 F-9 D

EXPRESS BAND

During the mountain climbing, express bands can provide additional safety when sling attached to carabiner.



D-01

DOOR ANCHOR

Door anchor is designed to install without compromising the structure in any way. There is no drilling or welding required, you simply compress the device between the vertical sides of the door or window and tighten.



WALL & BOLT ANCHORS

Designed for creating safe connecting point where it is difficult to find anchor point on the wall, pillar, joist and mesh type poles.



AP-1625 AP-716 AP-F1



AP-40 E AP-91 AP-90

GROUND & PROFILE ANCHORS

Designed for use on different type of structures as anchor point.



CT101



CT110



CT113



LW 100 CT 100

HARNESSES

LANYARDS & SHOCK ABSORBERS

CARABINERS

PULLEYS

ASCENDERS

DESCENDERS

HELMETS

MOBILE FALL ARRESTERS

RETRACTABLE FALL ARRESTERS

RESCUE DEVICES

STRETCHERS

ROPES

BAGS AND ACCESSORIES

SAFETY NETS

EDGE PROTECTION

TRIPOD AND CANTILEVER ARMS

ANCHORAGES

HORIZONTAL LIFELINE

VERTICAL LIFELINE

DEFENCE

LIFTING EQUIPMENT

I-BEAM ANCHORS

Designed for creating easy and safe connecting point by skidding through joists.



MAP-3 MAP-5 MAP-8

RIGGING PLATES

Designed for creating multiple anchor systems.



SW-10 B

SWIVEL

Prevents the rope from twisting when the load is turning.



F-6
ENDLESS TUBULAR SLING

- Used to create safe anchoring point for working at height.
- 20 mm polyester tubular webbing.
- UV and dust resistant bonded type high tenacity sewing thread (different color than webbing).

Strength : 23 kN
Length : 50 cm, 100 cm, 150 cm, 200 cm
Standard : EN 795/B:2012, EN 566:2006



F-7
ANCHORAGE SLING

- Used to create safe anchoring point for working at height.
- 50 mm width and 3 mm thick polyester webbing.
- 2 x S304 quality stainless steel D rings.
- UV and dust resistant bonded type high tenacity sewing thread (different color than webbing).

Strength : 23 kN
Length : 50 cm, 100 cm, 150 cm, 200 cm
Standard : EN 795/B:2012, EN 354:2010



WS-08
STEEL ANCHORAGE SLING

- PVC coated stainless steel wire rope of dia 8 mm.
- The PVC coating prevents exposure to dirt and chemicals, hence increases corrosion resistance of the lanyard.
- Ideal for cutting trees or welding at height.

Strength: 15 kN
Length: 50cm, 100cm, 150cm, 200cm
Standard: EN 795 B: 2012, EN 354:2010



F-9
EXPRESS BAND

- Used to create safe anchoring point for working at height.
- 20 mm tubular webbing.
- UV and dust resistant bonded type high tenacity sewing thread (different color than webbing).

Strength : 23 kN
Length : 12 cm, 17 cm, 22 cm
Standard : EN 795/B:2012, EN 354:2010



F-9 D
EXPRESS BAND DYNEEMA

- Used to create safe anchoring point for working at height.
- 20 mm dyneema tubular webbing.
- UV and dust resistant bonded type high tenacity sewing thread (different color than webbing).

Strength : 23 kN
Length : 12 cm, 17 cm, 22 cm
Standard : EN 795/B:2012, EN 354:2010



D-01

D-01 DOOR ANCHOR

- Designed for creating safe connecting point where it is difficult to find anchor point on the wall, pillar and joist.
- Corrosion-resistant.
- Adjustable in accordance with sizes of the door frames.

Loading capacity: 23 kN
Weight : 8.900 gr
Standard : EN 795/B:2012

D-02 DOOR ANCHOR

- Designed to fit door or window sizes from 60 cm to 130 cm in width.
- This equipment is designed for use by 2 persons with a combined weight of no more than 141 kg.
- There is no drilling or welding required.
- Portable and lightweight.
- Can be easily moved from one location to another, installed, removed and stored.

Weight : 5.900 gr
Standard : EN 795/B:2012



D-02



W-01 E



W-01 D

W-01 WALL ANCHORS

- Designed for creating safe connecting point where it is difficult to find anchor point on the wall, pillar and joist.
- Rust resistant.
- Doesn't cause any visual pollution at living areas.
- Consist of male & female parts only.
- Made of 316 grade stainless steel material.

Loading capacity: 23 kN
Weight : 375 gr
Standard : EN 795 A

Product types

- W-01 Wall Anchor
- W-01 D Wall anchor female component.
- W-01 E Wall anchor male component.



F-20 A



F-20 AP

F-20 A BOLT HANGER

Material : Stainless steel
Diameter: 10-12 mm
Strength : 30 kN
Weight : 40-45 gr
Standard: EN 795 A

F-20 AP BOLT HANGER SET

Material : Stainless steel
Diameter: 12 mm
Strength : 30 kN
Weight : 95 gr
Standard: EN 795 A

HARNESSES

LANYARDS &
SHOCK ABSORBERS

CARABINERS

PULLEYS

ASCENDERS

DESCENDERS

HELMETS

MOBILE FALL
ARRESTERS

RETRACTABLE
FALL ARRESTERS

RESCUE DEVICES

STRETCHERS

ROPES

BAGS AND
ACCESSORIES

SAFETY NETS

EDGE PROTECTION

TRIPOD AND
CANTILEVER
ARMS

ANCHORAGES

HORIZONTAL
LIFELINE

VERTICAL LIFELINE

DEFENCE

LIFTING
EQUIPMENT



TURTLE **DEADWEIGHT ANCHOR**

- It is a modular system consist of 18 easy-to-carry steel counterweights.
- The anchor's modular design eliminates a complicated assembly process and heavy-lifting.
- Each counterweight is 22,30 kg and come with an integral carrying handle for easy transport and set up.
- The anchor weighs 450 kg when assembled.
- It's extremely secure, with a unique load-distributing design, and is easily placed on any flat surface, providing a secure tie-off point for one user.
- Approved for use on concrete, membrane, wet and slippery surfaces.
- 360-Degree Rotation D-Ring with shock absorber provides great flexibility to user.

Weight : 450 kg
Standard: EN 795:2012 Type E





AP-716



AP-F1



AP-91



AP-1625



AP-90



AP-40 E

AP-716
POLE ANCHOR

- Designed to be used as an anchorage point on poles.
- Compatible with poles Dia 7-16 cm.
- Provided with assembly kit.
- No of users: 1

Standard: EN 795: 2012 Type A
Weight :3.750 gr

Types:
AP-716 S
Material: Stainless Steel
AP-716 G
Material: Galvanized Steel

AP-1625
POLE ANCHOR

- Designed to be used as an anchorage point on poles.
- Compatible with poles Dia 16-25 cm.
- Provided with assembly kit.
- No of users: 1

Standard: EN 795:2012 Type A
Weight :3.750 gr

Types:
AP-1625 S
Material: Stainless Steel
AP-1625G
Material: Galvanized Steel

AP-F1
REBAR ANCHOR

- Designed to be used as anchorage point on rebar on construction sites.
- Made of Aluminum.
- Compatible with rebar Dia 26-40 mm.
- Provided with assembly kit.

Standard: EN 795:2012 Type B
Weight : 160 gr

AP-90
PROFILE ANCHOR

- Designed to be used as anchorage point on flat surfaces.
- Made of 316 grade stainless steel.
- Easy to assemble.
- No of users: 2

Standard: EN 795:2012 Type A
CEN/TS 16415:2013 Type A
Weight : 550 gr

AP-91
PROFILE ANCHOR

- Designed to be used as anchorage point on flat surfaces.
- Made of 316 SS.
- Easy to assemble.
- No of users: 1
- Provides 360° rotation to user.

Standard: EN 795: 2012 Type A
Weight : 450 gr

AP-40 E
ANCHOR POINT

- Designed to be used as anchorage point on flat surfaces.
- Made of 316 SS.
- Provided with assembly kit.

Standard: EN 795: 2012 Type A
Weight : 2 kg

Types:
AP-40 E (Fixed Eyebolt)
AP-40 S (Swivel Eyebolt)

HARNESSES

LANYARDS & SHOCK ABSORBERS

CARABINERS

PULLEYS

ASCENDERS

DESCENDERS

HELMETS

MOBILE FALL ARRESTERS

RETRACTABLE FALL ARRESTERS

RESCUE DEVICES

STRETCHERS

ROPES

BAGS AND ACCESSORIES

SAFETY NETS

EDGE PROTECTION

TRIPOD AND CANTILEVER ARMS

ANCHORAGES

HORIZONTAL LIFELINE

VERTICAL LIFELINE

DEFENCE

LIFTING EQUIPMENT



CT110



CT101



CT101

BEAM SLIDER

- Lightweight, re-useable anchor clamp which can be attached to beams ranging from 76-305mm.
- Quick and easy to fit and adjust and no tools are required to mount the device.
- Can slide along the beam in either direction.

Body: Aluminum

Body color: Silver

Number of users: 1

(MBS) Minimum Breaking Strength (kN): 22

Standard: EN 795 B ANSI Z359.1-2007, ANSI Z359.1-2011, OSHA 1926.502

CT110

I BEAM SUPER SLIDER

- Lightweight, re-useable anchor clamp which can be attached to beams ranging from 305 mm – 762 mm.
- Quick and easy to fit and adjust and no tools are required to mount the device.
- Can slide along the beam in either direction.

Body: Aluminum

Body color: Silver

Number of users: 1

(MBS) Minimum Breaking Strength (kN): 22

Standard: EN 795 B ANSI Z359.1-2007, ANSI Z359.1-2011, OSHA 1926.502

CT113

FIXED VERTICAL BEAM ANCHOR

- Designed to clamp onto a horizontal I-Beam, to create a fixed anchor point.
- Can easily adjusted to firmly grip beams from 101-355 mm.
- The device is initially incrementally adjusted to fit the approximate size of the Beam, with final adjustment using the tightening Nut, which is fitted with a flip-out lever.
- The Beam has visual indicating features, allowing the user to easily identify when the device is loose, tightened or over-tightened.
- The lock button provides protection to prevent accidental opening/loosening, during use.
- The CT113 is fitted with a Swivel D Ring and is suitable for use in vertical and horizontal mounting.

(MBS) Minimum Breaking Strength (kN): 22

(WLL) Working Load Limit (kg): 454

Weight: 3.105 gr

Standard: EN 795:2012 Type B





CT100 BEAM TROLLEY

- Beam Trolley is a mobile anchor point, for use on structural beams.
- Fitted with toggle plates, which allow for simple adjustment of the rollers when installing/uninstalling the device.
- Ideal for use as an anchor connection for fall arrest systems (not suitable for material handling).
- No surface alteration (i.e. drilling) is required on order to use the Beam Trolley.
- Fitted with a swivel D ring.

Number of users: 1

Body: Aluminum

Body color: Silver

(MBS) Minimum Breaking Strength (kN): 22

Beam Width Range: 76 mm – 255 mm

Weight: 1.500 gr

Standard: EN 795:1996 Class B, OSHA 1910.66, ANSI Z359.1 -2007



LW 100 SERIES MOBILE I PROFILE SLIDER

- LW-100 is a mobile anchorage point for securing one person to an existing construction.
- Smooth-running design due to guide rollers with dual ball-bearings.
- Low-noise running characteristics due to polyamide rollers.
- Automatically follows in a vertical position above the user.
- Impact bumpers mounted on both sides.
- Available for various IPE beam sizes.

Standard: EN 795:1996 Class B,

Types	Profile Measurements
LW 100	100 mm
LW 120	120 mm
LW 160	160 mm
LW 200	200 mm
LW 100	100 mm
LW 270	270 mm
LW 360	360 mm



HARNESSES

LANYARDS &
SHOCK ABSORBERS

CARABINERS

PULLEYS

ASCENDERS

DESCENDERS

HELMETS

MOBILE FALL
ARRESTERS

RETRACTABLE
FALL ARRESTERS

RESCUE DEVICES

STRETCHERS

ROPES

BAGS AND
ACCESSORIES

SAFETY NETS

EDGE PROTECTION

TRIPOD AND
CANTILEVER
ARMS

ANCHORAGES

HORIZONTAL
LIFELINE

VERTICAL LIFELINE

DEFENCE

LIFTING
EQUIPMENT



ABL-M16 L (LEFT)

ABL-M16 R (RIGHT)



ABS-M16 L (LEFT)

ABS-M16 R (RIGHT)

ABL-M16 L **BOLT ANCHOR**

- Designed for creating easy and safe connecting point for climbing up mesh type pole.
- Suitable to use with M16 & M20 bolts.
- Simple installation to M16 & M20 bolts. Loosen the nut on the tip of the bolt, place the anchorage plate on than tighten back the nut to complete the installation.
- Made of 316 grade stainless steel material.
- Available in two types as left and right.

Strenght : 24 kN
Weight : 159 gr
Standard: EN 795

Product types

- **ABL-M16 L** (use with 16mm bolt)
- **ABL-M20 L** (use with 20mm bolt)
- **ABL-M16 R** (use with 16mm bolt)
- **ABL-M20 R** (use with 20mm bolt)

ABS-M16 L **BOLT ANCHOR**

- Designed for creating easy and safe connecting point for climbing up mesh type pole.
- Suitable to use with M16 & M20 bolts.
- Simple installation to M16 & M20 bolts. Loosen the nut on the tip of the bolt, place the anchorage plate on than tighten back the nut to complete the installation.
- Made of 316 grade stainless steel material.
- Available in two types as left and right.

Strenght : 24 kN
Weight : 141 gr
Standard: EN 795

Product types

- **ABS-M16 L** (use with 16mm bolt)
- **ABS-M20 L** (use with 20mm bolt)
- **ABS-M16 R** (use with 16mm bolt)
- **ABS-M20 R** (use with 20mm bolt)





MAP-3



MAP-5



MAP-8

MAP RIGGING PLATE

- Easy to create multiple anchor systems.
- Large holes allow the locking sleeves of most carabiners to pass through.
- Made of excellent strength Aluminum.

Strength: 36 kN

Weight : 3 gr (MAP-3)

: 5 gr (MAP-5)

: 8 gr (MAP-8)

Standard: EN 795/B:2012

Product Types

- **MAP-3** Multiple anchora plate (3 holes)
- **MAP-5** Multiple anchora plate (5 holes)
- **MAP-8** Multiple anchora plate (8 holes)



SW-10 B SWIVEL

- Prevents the rope from twisting when the load is turning.
- Excellent reliability due to maintenance- free sealed ball- bearings.
- 2 connectors can be attached to the ends.

Weight: 91 gr

HARNESSES

LANYARDS &
SHOCK ABSORBERS

CARABINERS

PULLEYS

ASCENDERS

DESCENDERS

HELMETS

MOBILE FALL
ARRESTERS

RETRACTABLE
FALL ARRESTERS

RESCUE DEVICES

STRETCHERS

ROPES

BAGS AND
ACCESSORIES

SAFETY NETS

EDGE PROTECTION

TRIPOD AND
CANTILEVER
ARMS

ANCHORAGES

HORIZONTAL
LIFELINE

VERTICAL LIFELINE

DEFENCE

LIFTING
EQUIPMENT





K-2010 HORIZONTAL LIFELINE



K-2010 A HORIZONTAL LIFELINE



K-2010 B HORIZONTAL LIFELINE

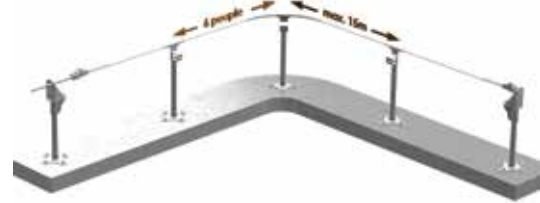

K-2010 C HORIZONTAL LIFELINE

PERMANENT HORIZONTAL LIFELINES

Permanent Horizontal Lifeline Systems allow workers freedom of movement along a horizontal axis while providing a hands-free fall protection. Made of 316 grade SS.



R27



R32

HORIZONTAL RAIL SYSTEM

System allows workers freedom of movement and the ability to lock into position while working on roof-top, crane runway, bridge or outdoor construction site, or any other elevated work area that poses a fall risk to personnel.



MHL

MOBILE HORIZONTAL LIFELINE

Mobile Horizontal Lifeline is specifically designed as a temporary horizontal anchor line for fall arrest purposes. This system can be used for any fall arrest application at height where a temporary anchor line is required. The system must be installed by competent person who has the necessary technical skills and training.

HARNESSES

LANYARDS & SHOCK ABSORBERS

CARABINERS

PULLEYS

ASCENDERS

DESCENDERS

HELMETS

MOBILE FALL ARRESTERS

RETRACTABLE FALL ARRESTERS

RESCUE DEVICES

STRETCHERS

ROPES

BAGS AND ACCESSORIES

SAFETY NETS

EDGE PROTECTION

TRIPOD AND CANTILEVER ARMS

ANCHORAGES

HORIZONTAL LIFELINE

VERTICAL LIFELINE

DEFENCE

LIFTING EQUIPMENT

K-2010

HORIZONTAL LIFELINE

- Allows workers freedom of movement along a horizontal axis while providing a hands-free fall protection.
- Main and intermediate anchor brackets are manufactured without welding. They do not deform after a possible fall. It is enough to change the wire rope and the shock absorber to make the system ready for re-use.
- The system is designed for 3 people to work at the same time.
- Recommended to be used together with fall arrest systems and safety harnesses.
- In the event of a fall protection accident, the energy of the fall will be absorbed by the integrated shock absorber.
- System components are made of 316 grade stainless steel.

System Components

- ANB-100 Main anchorage bracket
- ARB-100 Intermediate anchorage bracket
- SRY-50 or SRY-100 Slider
- EA-200 Shock absorber
- LL-200 Wire rope

Length : From 4 mt to desired length

Standard: EN 795:2012 Type C, CEN TS 16415:2013 Type C





K-2010 A

HORIZONTAL LIFELINE

- Allows workers freedom of movement along a horizontal axis while providing a hands-free fall protection.
- The shock absorber is located at the beginning and end of the system. This way the load from the main anchorage will be reduced to a minimum after a fall.
- The maximum distance between two anchor points is 20 meters.
- The system is designed for 6 people to work at the same time.
- Shock absorber has an indicator system which acts as a post-fall deformation.
- The whole system does not need to be changed after a fall, only the intermediate anchors need to be replaced by loosening the system.
- No special equipment is required for installation. As it can be done by our expert installation team, users can also install themselves with a proper training provided by the manufacturer.
- Special anchor plate design is made according to the area to be mounted.
- System components are made of 316 grade stainless steel.

Length : From 4 mt to desired length

Standard: EN 795:2012 Tip C, CEN TS 16415:2013 Type C

System Components

- ANB-100A Main anchorage bracket
- ARB-100A Intermediate anchorage bracket
- EA-200A Shock absorber
- LL-200A Wire rope





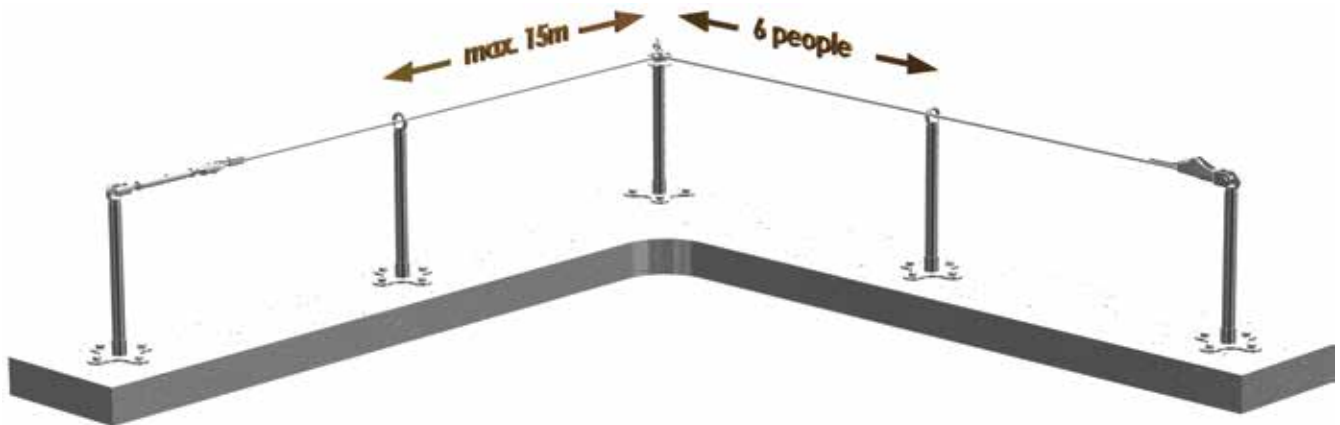

K-2010 B

K-2010 B HORIZONTAL LIFELINE (INTERMITTENT)

- It is designed as a permanent anchor point. The transition from the intermediate anchors is done using double leg lanyard.
- Tested for assembly to wall and floor and certified by the notified body.
- Designed in a construction that does not require a special shock absorber component, the AP-40E anchor post functions as a shock absorber, reducing the load on the system after a fall.
- The gap between two anchors is maximum 15 meters.
- All materials are made of 316 quality stainless steel.
- Suitable for use of up to 6 people at the same time.
- No special equipment is required for installation. As it can be done by our expert installation team, users can also install themselves by taking the necessary training when requested.

Length : 5 - meter (produced at desired length)

Standard: EN 795:2012 Type C, CEN/TS 16415:2013 Type C

The system consists of;

- AP-40 E Main anchor
- ES-300 U Rope finisher
- FS-14 Tensioner
- P-11 Q Pulley
- LL-200 B Wire rope

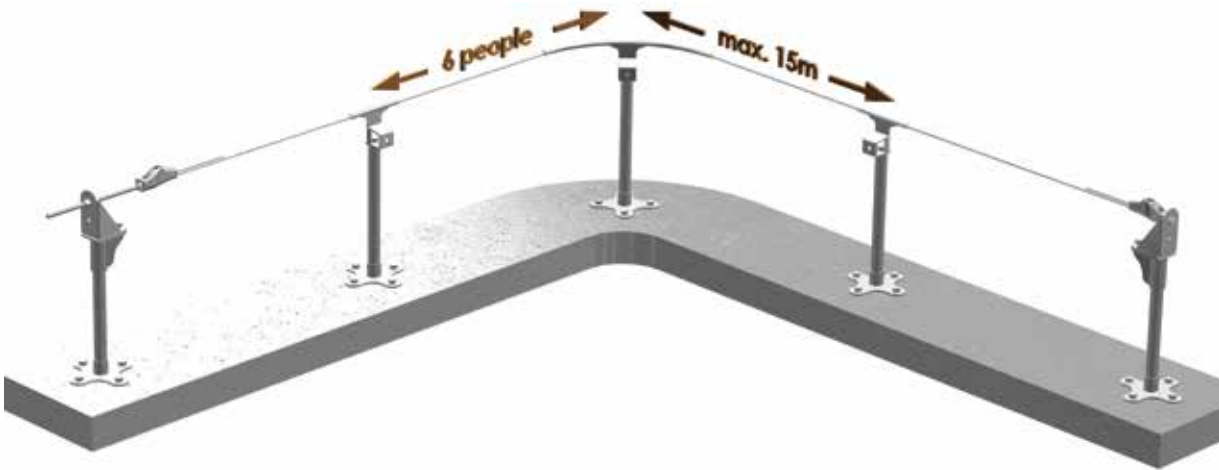

K-2010 C

K-2010 C HORIZONTAL LIFELINE (CONTINUOUS)

- Designed as continuous anchor point. Transitions from intermediate anchors are provided with the specially designed SRY-50 slider without having to exit from the line.
- Tested for assembly to wall and floor and certified by the notified body.
- Designed in a construction that does not require a special shock absorber component, the AP-40 anchor post functions as a shock absorber, reducing the load on the system after a fall.
- The gap between two anchors is maximum 15 meters.
- All materials are made of 316 quality stainless steel.
- Suitable for use of up to 6 people at the same time.
- No special equipment is required for installation. As it can be done by our expert installation team, users can also install themselves by taking the necessary training when requested.

Length : 5 - meter (produced at desired length)

Standard: EN 795:2012 Type C, CEN/TS 16415:2013 Type C

The system consists of;

- AP-40 Anchor post
- AP-40 A Anchor post
- ANB-100 A Main anchor
- ARB-100 B Intermediate anchor
- ARB-100 C1 Edge anchor
- ES-300 B Rope finishers
- ES-300 R Tensioner
- LL-200 C Wire rope

HARNESSES

LANYARDS &
SHOCK ABSORBERS

CARABINERS

PULLEYS

ASCENDERS

DESCENDERS

HELMETS

MOBILE FALL
ARRESTERS

RETRACTABLE
FALL ARRESTERS

RESCUE DEVICES

STRETCHERS

ROPES

BAGS AND
ACCESSORIES

SAFETY NETS

EDGE PROTECTION

TRIPOD AND
CANTILEVER
ARMS

ANCHORAGES

**HORIZONTAL
LIFELINE**

VERTICAL LIFELINE

DEFENCE

LIFTING
EQUIPMENT

K-2010 HORIZONTAL LIFELINE COMPONENTS



ANB-100
INTERMEDIATE ANCHOR

Material: 316 Grade
Stainless Steel.



ARB-100
MAIN ANCHOR

Material: 316 Grade
Stainless Steel.



EA-200
SHOCK ABSORBER

Material: 316 Grade
Stainless Steel.



LL-200
LIFELINE

Material: 316 Grade
Stainless Steel.
(7X19)

K-2010 A HORIZONTAL LIFELINE COMPONENTS



GRD-02
CONNECTION U ITEM

Material: 316 Grade
Stainless Steel.



ANB-100 A
MAIN ANCHOR

Material: 316 Grade
Stainless Steel.



ARB-100 A
INTERMEDIATE ANCHOR

Material: 316 Grade
Stainless Steel.



EA-200 A
ENERGY ABSORBER

Material: 316 Grade
Stainless Steel.



ES-300 B
WIRE INSTALLATION ITEM

Material: 316 Grade
Stainless Steel.



LL-200 A
LIFELINE

Material: 316 Grade
Stainless Steel. (7X7)



ARB-100 C1
CORNER ANCHOR

Material: 316 Grade
Stainless Steel.



ARB-100 C2
CORNER ANCHOR (ROOF)

Material: 316 Grade
Stainless Steel.

K-2010 B HORIZONTAL LIFELINE COMPONENTS



AP-40 E
POLE ANCHOR

Designed to be installed
on reinforced
concrete / steel columns.
Material: 316 Grade
Stainless Steel.



FS-14
TURNBUCKLE

Material: 316 Grade
Stainless Steel.



P-11 B
CORNER PULLEY

Material: 316 Grade
Stainless Steel.



ES-300 U
WIRE INSTALLATION
ITEM

Material: 316 Grade
Stainless Steel.



LL-200 B
LIFELINE

Material: 316 Grade
Stainless Steel.
(7X7)

K-2010 C HORIZONTAL LIFELINE COMPONENTS



ANB-100 A
MAIN ANCHOR

Material: 316 Grade
Stainless Steel.



AP-40 A
POLE ANCHOR

Designed to be installed
on reinforced
concrete / steel columns.

Material: 316 Grade
Stainless Steel.



ARB-100 A
INTERMEDIATE ANCHOR

Material: 316 Grade
Stainless Steel.



ARB-100 C1
CORNER ANCHOR

Material: 316 Grade
Stainless Steel.



ES-300 R
WIRE INSTALLATION ITEM

Material: 316 Grade
Stainless Steel.



LL-200 A
LIFELINE

Material: 316 Grade
Stainless Steel.
(7 X 7)



ES-300 B
WIRE INSTALLATION ITEM

Material: 316 Grade
Stainless Steel.

HORIZONTAL LIFELINE SLIDERS



SRY-50
SLIDER

Material: 316 Grade Stainless Steel.



SRY-200
SLIDER

Material: 316 Grade Stainless Steel.

HARNESSES

LANYARDS &
SHOCK ABSORBERS

CARABINERS

PULLEYS

ASCENDERS

DESCENDERS

HELMETS

MOBILE FALL
ARRESTERS

RETRACTABLE
FALL ARRESTERS

RESCUE DEVICES

STRETCHERS

ROPES

BAGS AND
ACCESSORIES

SAFETY NETS

EDGE PROTECTION

TRIPOD AND
CANTILEVER
ARMS

ANCHORAGES

HORIZONTAL
LIFELINE

VERTICAL LIFELINE

DEFENCE

LIFTING
EQUIPMENT

HORIZONTAL LIFELINE ANCHORS



HL-D 64
POLE ANCHOR

Designed to be installed on various type of metal and concrete surfaces.

Material: Steel
Surface Application: Electrostatic Powder Coating.



HL-K.000.042
FLAT ANCHOR

Designed to be installed on various type of metal and concrete surfaces.

Material: Steel
Surface Application: Electrostatic Powder Coating.



HL-K.089.005
CONSOLE ANCHOR

Designed to be installed on various type of metal and concrete surfaces.

Material: Steel
Surface Application: Electrostatic Powder Coating.



HL-PK. 225
BUTTRESS CONSOLE ANCHOR

Material: 316 Grade Stainless Steel
Surface Application: Electrostatic Powder Coating.



HL-P.5-10
PROFILE ANCHOR

Material: 316 Grade Stainless Steel.

Available Types
HL-P.5-10 HL-P.10-15
HL-P.15-20 HL-P.20-25
HL-P.25-30 HL-P.30-35



HL-S5
PROFILE ANCHOR

Material: Steel
Surface Application: Electrostatic Powder Coating.



HL-RA
SANDWICH PANEL & SEAM ROOF ANCHOR

Sandwich Panel Connectors

- Smart Screw with EPDM Seal
- Rivet
- Dowel

Seam Roof Connectors

- S-S Clamps

Material: Aluminum



K-2010 HORIZONTAL LIFELINE SYSTEM- TRUCK LOADING & UNLOADING



K-2010 HORIZONTAL LIFELINE SYSTEM- TRUCK LOADING & UNLOADING

HARNESSES

LANYARDS &
SHOCK ABSORBERS

CARABINERS

PULLEYS

ASCENDERS

DESCENDERS

HELMETS

MOBILE FALL
ARRESTERS

RETRACTABLE
FALL ARRESTERS

RESCUE DEVICES

STRETCHERS

ROPES

BAGS AND
ACCESSORIES

SAFETY NETS

EDGE PROTECTION

TRIPOD AND
CANTILEVER
ARMS

ANCHORAGES

**HORIZONTAL
LIFELINE**

VERTICAL LIFELINE

DEFENCE

LIFTING
EQUIPMENT

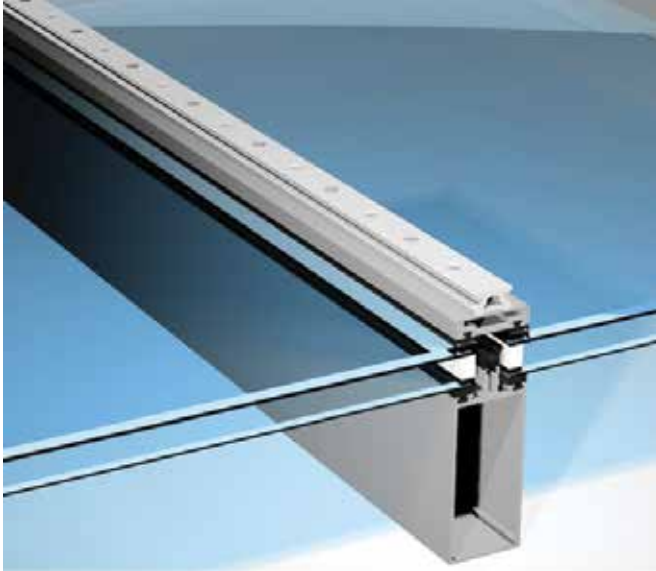

R27

HORIZONTAL RAIL SYSTEM

- Rigid Class D fall arrest rail system.
- Anodized aluminum T6 6061 for high corrosion resistance.
- Small dimension: 19x32 mm
- Torlon® recirculating balls car, for a high strength and smoothness.
- Any position mounting (wall, ceiling).
- Fixing in adhesion to the laying surface.

Maximum Working Load: 300 kg

Standard : EN 795.2012 Type D, CEN/TS 16415 for 4 operators.

Resistance : The Access Rail system is designed for extreme marine conditions and requires only minimal maintenance, even when it is installed in tough condition.

Safety : The Rail systems provide a reliable solution for single-person in fall restraint in the fall arrest and suspended working applications. When appropriately positioned and installed with PPE Personal Protection Equipment, the Access Rail allows the operator to work at height locked in position, with the ability to change the position when it is required.

Flexibility : Rail and cars can be mounted to slide from multiple positions. A wheel toggle attachment is available to achieve a 90-degree angle.



HARNESSES

LANYARDS &
SHOCK ABSORBERS

CARABINERS

PULLEYS

ASCENDERS

DESCENDERS

HELMETS

MOBILE FALL
ARRESTERS

RETRACTABLE
FALL ARRESTERS

RESCUE DEVICES

STRETCHERS

ROPES

BAGS AND
ACCESSORIES

SAFETY NETS

EDGE PROTECTION

TRIPOD AND
CANTILEVER
ARMS

ANCHORAGES

**HORIZONTAL
LIFELINE**

VERTICAL LIFELINE

DEFENCE

LIFTING
EQUIPMENT

RAIL AND CAR MOUNTING POSITIONS

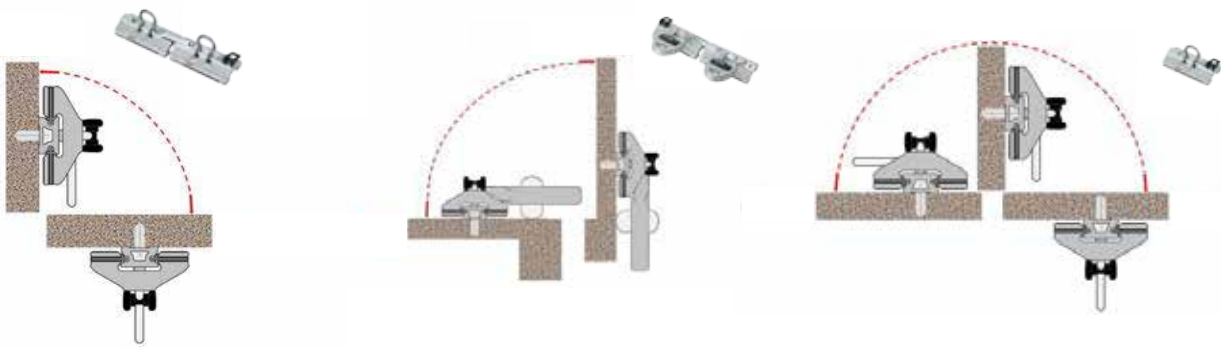

COMPONENTS



IN1643



IN9561



IN1642



IN1649



IN9565



IN9608



IN9606



IN10567





MHL SERIES
MOBILE HORIZONTAL LIFELINE

- Easy to assemble.
- Adjustable length (4-20 mt).
- Certified to be used by 3 people at once.
- Provided with 3 x O rings to reduce abrasion.
- Has integrated shock absorber.

Standard: EN 795:2012 Type C, CEN/TS 16415:2013 Type C

Types:

MHL-20 Set: 5 x F-7 Anchor sling (2 mt) + 3 x K-14/3A 50 kN carabiner)

MHL-20 : 2 x F-7 Anchor sling (2 mt)



**K-14/3A
CARABINER**



**F-7
ANCHORAGE SLING**

HARNESSES

LANYARDS &
SHOCK ABSORBERS

CARABINERS

PULLEYS

ASCENDERS

DESCENDERS

HELMETS

MOBILE FALL
ARRESTERS

RETRACTABLE
FALL ARRESTERS

RESCUE DEVICES

STRETCHERS

ROPES

BAGS AND
ACCESSORIES

SAFETY NETS

EDGE PROTECTION

TRIPOD AND
CANTILEVER
ARMS

ANCHORAGES

**HORIZONTAL
LIFELINE**

VERTICAL LIFELINE

DEFENCE

LIFTING
EQUIPMENT





K-2020



K-2025

VERTICAL LIFELINES

Vertical lifeline is a permanent system that provides hands free fall protection for climbing ladders and other vertical structures. Available either with (K-2020) or without (K-2025) an energy absorber integrated in the top bracket.

HARNESSES

LANYARDS &
SHOCK ABSORBERS

CARBINERS

PULLEYS

ASCENDERS

DESCENDERS

HELMETS

MOBILE FALL
ARRESTERS

RETRACTABLE
FALL ARRESTERS

RESCUE DEVICES

STRETCHERS

ROPES

BAGS AND
ACCESSORIES

SAFETY NETS

EDGE PROTECTION

TRIPOD AND
CANTILEVER ARMS

ANCHORAGES

HORIZONTAL
LIFELINE

VERTICAL LIFELINE

DEFENCE

LIFTING
EQUIPMENT



K-2020

VERTICAL LIFELINE WITH INTEGRATED SHOCK ABSORBER

- System is made of 316 Grade Stainless Steel.
- Brackets are designed for ladder rungs but can be easily adapted to most structures.
- Sold as complete system.

System Components

- AP-300A Top anchorage bracket
- AP-300B Bottom anchorage bracket
- FA-50 Shock Absorber
- FS-40 Turnbuckle
- FC-30V Rope Guide
- LL-150 Wire rope

Note: System must be used only with F-5A Rope Grab

Length : From 3 mt to desired length

Standard: EN 353-1:2014



F-5

WIRE ROPE GRAB (FALL ARRESTER)

- Made of Stainless Steel.
- It is secured with a K-2/3ACP carabiner. Use of non-authorized carabiner can cause fatal accidents.
- The user is free to climb and descend with full use of the hands.

Standard: EN 353-1:2014



K-2020A

VERTICAL LIFELINE WITH EXTENDED TOP BRACKET (SHOCK ABSORBER INTEGRATED)

- System is made of 316 Grade Stainless Steel.
- Brackets are designed for ladder rungs but can be easily adapted to most structures.
- Sold as complete system.

System Components

- AP-300I Extended top anchorage bracket
- AP-300B Bottom anchorage bracket
- FA-50 Shock Absorber
- FS-40 Turnbuckle
- FC-30V Rope Guide
- LL-150 Wire rope

Note: System must be used only with F-5A Rope Grab.

Length : From 3 mt to desired length

Standard: EN 353-1:2014



F-5

WIRE ROPE GRAB (FALL ARRESTER)

- Made of Stainless Steel
- It is secured with a K-2/3ACP carabiner. Use of non-authorized carabiner can cause fatal accidents.
- The user is free to climb and descend with full use of the hands.

Standard: EN 353-1:2014

HARNESSES

LANYARDS &
SHOCK ABSORBERS

CARABINERS

PULLEYS

ASCENDERS

DESCENDERS

HELMETS

MOBILE FALL
ARRESTERS

RETRACTABLE
FALL ARRESTERS

RESCUE DEVICES

STRETCHERS

ROPES

BAGS AND
ACCESSORIES

SAFETY NETS

EDGE PROTECTION

TRIPOD AND
CANTILEVER ARMS

ANCHORAGES

HORIZONTAL
LIFELINE

VERTICAL LIFELINE

DEFENCE

LIFTING
EQUIPMENT



K-2025 **VERTICAL LIFELINE**

- System is made of 316 Grade Stainless Steel.
- Brackets are designed for ladder rungs but can be easily adapted to most structures.
- Sold as complete system.

System Components

- AP-300A Top anchorage bracket
- AP-300B Bottom anchorage bracket
- FS-40 Turnbuckle
- FC-30 Rope Guide
- FC-30V Rope Guide
- LL-150 Wire rope

Note: System must be used only with F-5A Rope Grab.

Length : From 3 mt to desired length

Standard: EN 353-1:2014



F-5A **WIRE ROPE GRAB WITH SHOCK ABSORBER**

- Made of 316 Grade Stainless Steel.
- It is secured with a K-2/3ACP carabiner. Use of non-authorized carabiner can cause fatal accidents.
- The user is free to climb and descend with full use of the hands.

Standard: EN 353-1:2014



K-2025A

VERTICAL LIFELINE WITH EXTENDED TOP BRACKET

- System is made of 316 Grade Stainless Steel.
- Brackets are designed for ladder rungs but can be easily adapted to most structures.
- Sold as complete system.

System Components

- AP-300I Extended top anchorage bracket
- AP-300B Bottom anchorage bracket
- FS-40 Turnbuckle
- FC-30V Rope Guide
- FC-30 Rope Guide
- LL-150 Wire rope

Note: System must be used only with F-5A Rope Grab.

Length : From 3 mt to desired length

Standard: EN 353-1:2014



F-5A

WIRE ROPE GRAB WITH SHOCK ABSORBER

- Made of 316 Grade Stainless Steel.
- It is secured with a K-2/3ACP carabiner. Use of non-authorized carabiner can cause fatal accidents.
- The user is free to climb and descend with full use of the hands.

Standard: EN 353-1:2014

HARNESSES

LANYARDS &
SHOCK ABSORBERS

CARABINERS

PULLEYS

ASCENDERS

DESCENDERS

HELMETS

MOBILE FALL
ARRESTERS

RETRACTABLE
FALL ARRESTERS

RESCUE DEVICES

STRETCHERS

ROPES

BAGS AND
ACCESSORIES

SAFETY NETS

EDGE PROTECTION

TRIPOD AND
CANTILEVER ARMS

ANCHORAGES

HORIZONTAL
LIFELINE

VERTICAL LIFELINE

DEFENCE

LIFTING
EQUIPMENT



AP-300A



FA-50



FS-40



AP-300B



FC-30V



LL-100

AP-300A
TOP ANCHORAGE BRACKET

- 316 grade stainless steel.

Standard: EN 353-1:2014

FA-50
SHOCK ABSORBER

- 316 grade stainless steel.

Standart: EN 353-1:2014

FS-40
TURNBUCKLE

- 316 grade stainless steel.

Standard: EN 353-1:2014

AP-300B
BOTTOM ANCHORAGE BRACKET

- 316 grade stainless steel.

Standard: EN 353-1:2014

FC-30V
ROPE GUIDE

- 316 grade stainless steel.
- Installed every 10 mt

Standard: EN 353-1:2014

LL-100
LIFELINE

- 316 grade stainless steel.

Standard: EN 353-1:2014



AP-300C



FS-40



AP-300B



FC-30V



LL-150

AP-300C TOP ANCHORAGE BRACKET

- 316 grade stainless steel.

Standard: EN 353-1:2014

AP-300B BOTTOM ANCHORAGE BRACKET

- 316 grade stainless steel.

Standard: EN 353-1:2014

FS-40 TURNBUCKLE

- 316 grade stainless steel.

Standard: EN 353-1:2014

FC-30V ROPE GUIDE

- 316 grade stainless steel.

Standard: EN 353-1:2014

LL-150 LIFELINE

- 316 grade stainless steel.

Standard: EN 353-1:2014

HARNESSES

LANYARDS &
SHOCK ABSORBERS

CARABINERS

PULLEYS

ASCENDERS

DESCENDERS

HELMETS

MOBILE FALL
ARRESTERS

RETRACTABLE
FALL ARRESTERS

RESCUE DEVICES

STRETCHERS

ROPES

BAGS AND
ACCESSORIES

SAFETY NETS

EDGE PROTECTION

TRIPOD AND
CANTILEVER ARMS

ANCHORAGES

HORIZONTAL
LIFELINE

VERTICAL LIFELINE

DEFENCE

LIFTING
EQUIPMENT



AP-300 I
EXTENDED TOP BRACKET

- Made of 304 grade stainless steel.
- Integrated with the top bracket.

Standard: EN 353-1:20214









P-455 YO D BLACK
FALL ARREST AND WORK POSITIONING
SUSPENSION HARNESS

- Designed for fall arrest, rope access, restraint, work positioning, controlled descent and rescue purposes.
- Has 5 attachment points;
1 x Dorsal and 1 Sternal D - Ring for Fall Arrest.
1 x Ventral D - Ring at waist level for Rope Access work.
2 x Lateral D - Rings for Work Positioning.
- Suspension leg straps allows for increased comfort.
- Maximum comfort by breathing, antibacterial and ergonomic waist, leg and shoulder pads.
- Easy use aluminum automatic buckles for fast connection and release. Equipped with visual locking indicator.
- Easy use and ergonomic steel buckles on shoulder.
- UV resistant high strength bonded type sewing yarns and contrastive color sewing in CNC machineries for quick eye control.
- 4 gear loops on waist belt.
- The protective case protects the information tag visually and enables users to log annual inspections.

Size : S/M, L/XL, XXL
Weight : 2.420 gr (S/M), 2.510 gr (L/XL), 2.630 gr (XXL)
Color : Black
Standard: EN 361, EN 358, EN 813, EN 12277



P-455 Y BLACK
FALL ARREST AND WORK POSITIONING
SUSPENSION HARNESS

- Designed for fall arrest, rope access, restraint, work positioning, controlled descent and rescue purposes.
- Has 5 attachment points;
1 x Dorsal and 1 Sternal D - Ring for Fall Arrest.
1 x Ventral D - Ring at waist level for Rope Access work.
2 x Lateral D - Rings for Work Positioning.
- Suspension leg straps allows for increased comfort.
- Maximum comfort by breathing, antibacterial and ergonomic waist, leg and shoulder pads.
- Easy use and ergonomic steel buckles.
- UV resistant high strength bonded type sewing yarns and contrastive color sewing in CNC machineries for quick eye control.
- 4 gear loops on waist belt.
- The protective case protects the information tag visually and enables users to log annual inspections.

Size : S/M, L/XL, XXL
Weight : 1.878 kg (S/M), 1.970 kg (L/XL), 2.079 kg (XXL)
Color : Black
Standard : EN 361, EN 358, EN 813, EN 12277

HARNESSES

LANYARDS &
SHOCK ABSORBERS

CARABINERS

PULLEYS

ASCENDERS

DESCENDERS

HELMETS

MOBILE FALL
ARRESTERS

RETRACTABLE
FALL ARRESTERS

RESCUE DEVICES

STRETCHERS

ROPES

BAGS AND
ACCESSORIES

SAFETY NETS

EDGE PROTECTION

TRIPOD AND
CANTILEVER ARMS

ANCHORAGES

HORIZONTAL
LIFELINE

VERTICAL LIFELINE

DEFENCE

LIFTING
EQUIPMENT



TS-30
SUSPENSION TRAUMA STRAPS

- Designed to prevent suspension trauma while a worker is awaiting rescue.
- Helps suspended users to overcome the potential negative health impacts of suspension trauma.
- Made of 30 mm High Tenacity Webbing.
- Comes with Fast Adjustable Buckles Attached to the Webbing.

Weight: 188 gr (2 pcs)
Color : Black



STAR
BOSUN'S CHAIR

- Ideal for working short or extended periods in suspension; windows cleaning, maintenance, painting etc.
- 3 x gear loops.
- Does not provide any fall protection and must be used with an appropriate fall arrest and rescue system.

Weight : 1.420 gr
Color : Black

STAR COMFORT
BOSUN'S CHAIR

- Ideal for working short or extended periods in suspension; windows cleaning, maintenance, painting etc.
- Wide Sitting Area Provides Comfortable Sitting and Working Position.
- Webbing ladder for resting.
- 3 x gear loops.
- Does not provide any fall protection and must be used with an appropriate fall arrest and rescue system.

Weight : 1.530 gr
Color : Black



ACB-40B
CLIMBING & RAPPELLING BELT

- Designed for tactical situations with long hang time.
- Quick adjust buckles to accommodate a variety of sizing requirements.
- Made of 40 or 45 mm high tenacity polyester webbing.
- 1 x Aluminum K-13/3A triple action karabiner.

Size : S/M, L/XL, XXL
Weight : 439 gr
Color : Black
Standard: ISO 9001: 2008

ACB-40D
CLIMBING & RAPPELLING BELT

- Designed for tactical situations with long hang time.
- Quick adjust buckles to accommodate a variety of sizing requirements.
- Made of 40 or 45 mm high tenacity polyester webbing.
- 1 x Aluminum K-13/3A triple action karabiner.

Size : S/M, L/XL, XXL
Weight : 536 gr
Color : Desert
Standard: ISO 9001: 2008

HARNESSES

LANYARDS & SHOCK ABSORBERS

CARABINERS

PULLEYS

ASCENDERS

DESCENDERS

HELMETS

MOBILE FALL ARRESTERS

RETRACTABLE FALL ARRESTERS

RESCUE DEVICES

STRETCHERS

ROPES

BAGS AND ACCESSORIES

SAFETY NETS

EDGE PROTECTION

TRIPOD AND CANTILEVER ARMS

ANCHORAGES

HORIZONTAL LIFELINE

VERTICAL LIFELINE

DEFENCE

LIFTING EQUIPMENT



RB-45B



RB-40D

RB-45B

RAPPELING BELTS

- Designed for Emergency Rappel.
- Made of 45 mm high tenacity polyester webbing.
- Quick adjust buckles to accommodate a variety of sizing requirements.

Size : S/M, L/XL, XXL
Weight : 242 gr
Color : Black
Standard: ISO 9001: 2008

RB-40D

RAPPELING BELTS

- Designed for Emergency Rappel.
- Made of 40 mm high tenacity polyester webbing.
- Quick adjust buckles to accommodate a variety of sizing requirements.

Size : S/M, L/XL, XXL
Weight : 322 gr
Color : Desert
Standard: ISO 9001: 2008



DL-25B



DL-25D

DL-25B

RAPPELING LANYARD

- Made of high tenacity polyester webbing.
- 5 attachment loops.
- Total length is 57 cm.
- Available in Black and Desert color.

Weight : 48,50 gr
Color : Black
Standard: ISO 9001: 2008

DL-25D

RAPPELING LANYARD

- Made of high tenacity polyester webbing.
- 5 attachment loops.
- Total length is 57 cm.
- Available in Black and Desert color.

Weight : 53,50 gr
Color : Desert
Standard: ISO 9001: 2008



I-451
RESCUE HARNESS

- 1 x special design abdominal aluminium D-Ring for Fast, Easy and Safe Connection to the Other Elements of a Personal Fall Arrest System.
- Maximum comfort by virtue of Breathing, Antibacterial, Ergonomic Waist and Leg Pads.
- Stainless steel QB-45 Quick Buckles For Fast Connection and Release.
- UV Resistant High Strength Bonded Type Yarns and Contrastive Color Sewing for Quick Eye Control.
- 2 x Gear Loops.

Size : S/M, L/XL
Weight : 900 gr (S/M), 970 gr (L/XL)
Color : Black
Standard: EN 12277



I-451 A
CLIMBING HARNESS

- 1 x abdominal anhorage point.
- Maximum comfort by virtue of Breathing, Antibacterial, Ergonomic Waist and Leg Pads.
- Stainless steel QB-45 Quick Buckles For Fast Connection and Release.
- UV Resistant High Strength Bonded Type Yarns and Contrastive Color Sewing for Quick Eye Control.
- 4 x Gear Loops.

Size : S/M, L/XL
Weight : 600 gr (S/M), 660 gr (L/XL)
Color : Black
Standard: EN 12277

HARNESSES

LANYARDS & SHOCK ABSORBERS

CARABINERS

PULLEYS

ASCENDERS

DESCENDERS

HELMETS

MOBILE FALL ARRESTERS

RETRACTABLE FALL ARRESTERS

RESCUE DEVICES

STRETCHERS

ROPES

BAGS AND ACCESSORIES

SAFETY NETS

EDGE PROTECTION

TRIPOD AND CANTILEVER ARMS

ANCHORAGES

HORIZONTAL LIFELINE

VERTICAL LIFELINE

DEFENCE

LIFTING EQUIPMENT



E-3 W SERIES

TWIN – LEG SHOCK ABSORBING WEBBING LANYARD

- Twin-leg model allows user to keep one leg attached to the anchorage while the other leg is always ready to be hooked to the next anchorage.
- Made of highly resistant polyester webbing.
- Built-in energy absorber limits the fall arrest force in a fall situation by tearing specific seams.
- Zippered fabric case protects the energy absorber from abrasion and other damages while allowing for regular inspection of the absorber.
- Stitched in professional CNC machines by bonded type UV and dust resistant high tenacity yarn.

Models

- **E-3 W K-4A/K-2** Bottom: **K-2** type carabiner
Top : **K-4A** type carabiner
- **E-3 W K-6/K-2** Bottom: **K-2** type carabiner
Top : **K-6** type carabiner

Length : 1, 2 & 2 mt

Standard: EN 354, EN 355, EN 362, EN 12275

CARABINER OPTIONS

Note: For more information please check section: Carabiners



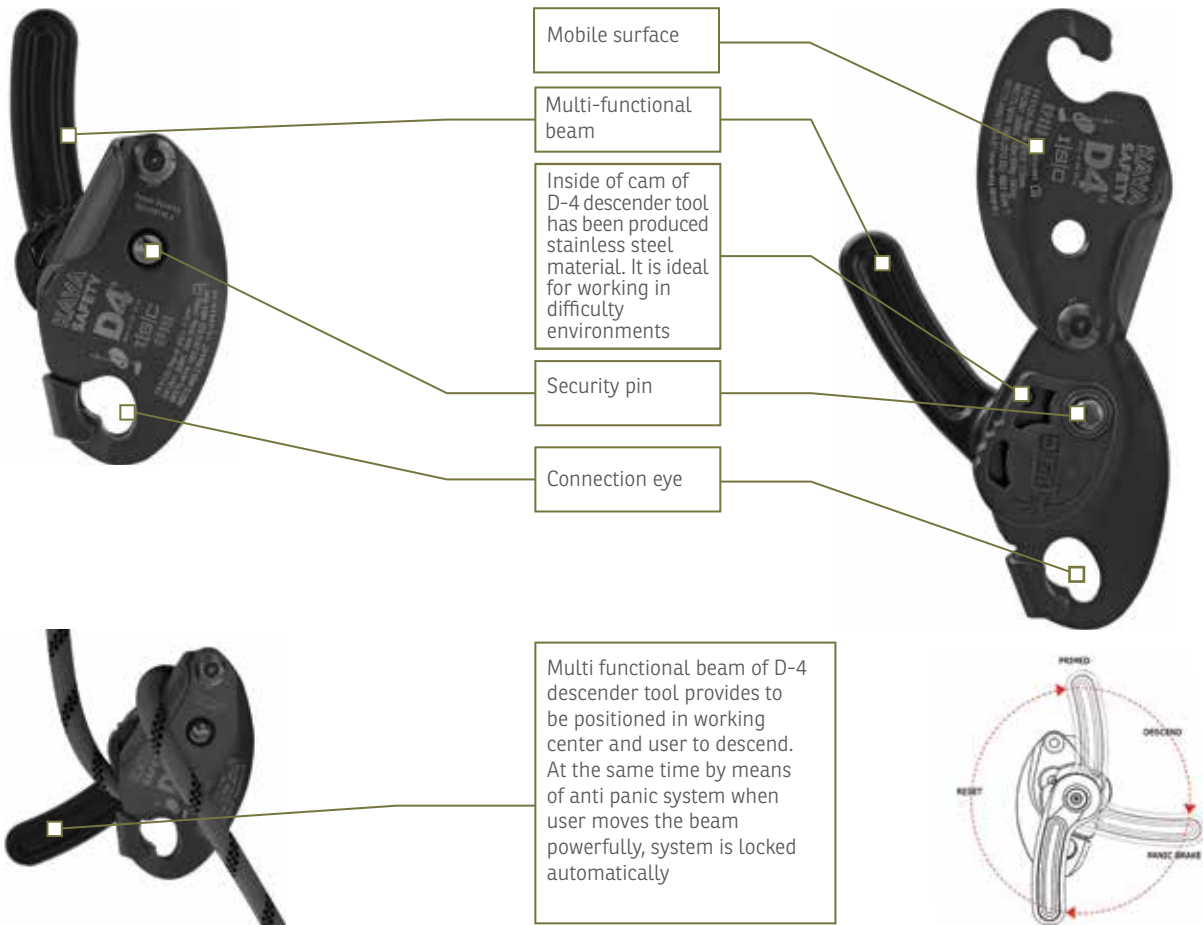

D-4 DESCENDER (ANTI-PANIC SYSTEM)

- D4 controlled descender tool is designed for working on rope. D4 enables a unique movement in vertical, horizontal and angled works on rope.
- It will be attached or deductible to system in any point of rope.
- The progressive cam works by way of one cam operating inside another cam.
- In the working with rope, the gap on rope is taken easily.
- It can work by hands free in lock position and can get work position.
- It owns D4 240 kg work weight. Meaning of this is available for rescue work without being required to extra friction.
- The handle mechanism is designed to rotate through 360° making its use easier and simpler. The handle itself is made from aluminum rather than plastic and is coated in a specially chosen paint which provides extra grip.
- The handle rotation is accompanied by audible clicks which help the user identify the correct position of the handle.
- By means of anti-panic system, when the user winds up strongly, system is locked automatically.
- The outer body is made of high strength aluminum material.
- Inner cam is made of stainless steel material.
- Minimum breaking strength is 16 kN.

Rope Dia: Ø 10,5 – 11,5 mm

Weight : 655 gr

Standard: EN 12841, EN 341, ANSI Z359, NFPA 1983

HARNESSES

LANYARDS &
SHOCK ABSORBERS

CARABINERS

PULLEYS

ASCENDERS

DESCENDERS

HELMETS

MOBILE FALL
ARRESTERS

RETRACTABLE
FALL ARRESTERS

RESCUE DEVICES

STRETCHERS

ROPES

BAGS AND
ACCESSORIES

SAFETY NETS

EDGE PROTECTION

TRIPOD AND
CANTILEVER ARMS

ANCHORAGES

HORIZONTAL
LIFELINE

VERTICAL LIFELINE

DEFENCE

LIFTING
EQUIPMENT



A-1 L **A-1 R**

A-1
JUMAR (LEFT AND RIGHT)

- Used for ascending on a rope.
- Aluminum alloy material.
- Top captive eyes are to be used with pulleys or rope grabs.
- Lower captive eye is to be used with webbing ladder.
- Outer coating is for comfortable hand grip.

Rope Dia : Ø 8 -13 mm
Weight : 238 gr
Color : Black
Standard : EN 567, UIAA

Product Types

A-1 L: Left hand
A-1 R: Right hand



SE-15

SE-15
ADJUSTABLE WEBBING FOOT LOOP

- Easy to use for ascending.
- High strength of 25 mm polyester webbing.
- Easily adjusted length with QB-25 quick buckles.
- Bonded type high tenacity sewing.

Length : 1,5 m
Strength : 23 kN
Color : Black
Weight : 180 gr



SE-30

SE-30
ADJUSTABLE ETRIER

- Reinforced steps for durability and ease of use when ascending a rope or aid climbing in rope Access.
- High strength of 25 mm polyester webbing.
- Easily adjustable QB-25 quick buckles.
- Bonded type high tenacity sewing.
- 3 step with top adjustment.

Length : 1,5 m
Strength : 23 kN
Color : Black
Weight : 185 gr



K-13/SL



K-13/2A



K-13/3A

K-13 SERIES
ASYMMETRICAL ALUMINUM CARABINER

- Specially adapted for attaching equipment.
- Excellent strength-to-weight ratio.
- Keylock system helps prevent snagging of the carabiner during maneuvers.
- Red indicator provides a visual warning when the carabiner is unlocked (on SCREW-LOCK version).

Strength : 22 kN
Gate Opening: 21 mm
Color : Black
Weight : 82 gr (K-13/SL),
86 gr (K-13/2A),
87 gr (K-13/3A)
Standard : EN 362, EN 12275

Locking Types

- **K-13/SL** Screw Locking
- **K-13/2A** Double action - auto locking
- **K-13/3A** Triple action - auto locking

ASCENDERS



D-13



RP-400

D-13
BELAY DEVICE

- Used to control a rope during belaying.
 - Ultra-compact design is easy to use and doesn't take up much space.
 - Act as a friction brake, so that when a climber falls with any slack in the rope, the fall is brought to a stop.
 - Breaking strength: 23 kN.
 - Made of aluminum alloy material.
- Rope Dia** : Ø 8 -13 mm
Weight : 270 gr
Color : Black

RP-400
PRO ALLP DESCENDER

- The Pro Allp Descender is a multi-function device.
 - Adjustable, Screw Controlled Descender.
 - Auto-lock Controlled Descender (with variable maximum speed setting).
 - Can be used for rescue operations.
 - Breaking strength: 30 kN.
 - Made of aluminum alloy material.
 - 316 grade stainless steel material.
 - Outer frame is made of aluminum material.
- Rope Dia** : Ø 10,5 – 12,7 mm
Weight : 580 gr
Color : Black
Standard : EN 12841-B

DESCENDERS



D-8



D-9

D-8
FIGURE 8

- Ease of use for descending.
- For easy descending on single or double ropes.
- Breaking strength: 30 kN.
- Made of aluminum alloy material.

Rope Dia : Ø 8 -13 mm
Weight : 119 gr
Color : Black
Standard : EN 795 Class B, EN 12278

D-9
BENT EAR FIGURE 8

- It enables descent by using rescue figure 8 descender more controlled.
- Breaking strength: 40 kN.
- It is made of aluminium alloy material.

Rope Dia : Ø 8 -13 mm
Weight : 270 gr
Color : Black
Standard : EN 795 Class B, EN 12278

ROPE GRAB



RP-500 ROCKER
ROPE GRAB

- Designed for use without a shock-absorber.
- Can be fitted to the rope at any point.
- Can be used hands-free, when travelling up and down the rope.
- The Rocker can also be used as a Rope Adjuster on a Work Positioning Lanyard (in accordance with EN358).
- The Rocker is fitted with non-aggressive 'rope friendly' cam faces.

Weight : 164 gr
Material : Aluminum
Rope Dia : Ø 10,5 – 12,7 mm
 (Use only with rope certificated according to EN 1891 Type A)
Standard: CE EN 353-2; CE EN358; CE EN 12841-A
Color : Black

HARNESSES

LANYARDS & SHOCK ABSORBERS

CARABINERS

PULLEYS

ASCENDERS

DESCENDERS

HELMETS

MOBILE FALL ARRESTERS

RETRACTABLE FALL ARRESTERS

RESCUE DEVICES

STRETCHERS

ROPES

BAGS AND ACCESSORIES

SAFETY NETS

EDGE PROTECTION

TRIPOD AND CANTILEVER ARMS

ANCHORAGES

HORIZONTAL LIFELINE

VERTICAL LIFELINE

DEFENCE

LIFTING EQUIPMENT



H-13 ISLAND INDUSTRIAL HELMET

- Ideal for rescue operation and works at height.
- Slots for ear protectors fixing.
- Adjustable and removable chinstrap.
- Ventilation with 2 vents.

Color : Black
Size : 54/62 cm
Weight : 400 gr
Outer shell: Thermo ABS
Inner shell : High Tenacity polystyrene EPS foam
Standard : EN 397

ACCESSORIES



SHORT VISOR



LONG VISOR



VISOR+EAR MUFFS



RL-10 CONIC STRETCHER

- Ideal for confined space, high angle or technical rescue, and traditional land based applications.
- Equipped with 2 pieces of 35 kN slings for horizontal hoisting by helicopter or vertical hoisting in caves or industrial confined spaces.
- When the patient is packaged the stretcher becomes rigid.
- Main body is made of high strength polyethylene material.
- Eyelets rivets on the belts are made of stainless steel.
- 1 piece of 23 Kn strength vertical evacuation rope.
- 4 pieces of handles (2for each on left and right side of the stretcher).
- 4 pieces of slings to be connected on eyelets rivets.
- 1 pcs of 50 kN triple action karabiner.
- The stretcher is rolled for storage in a tough backpack which is included with the system.
- Stretcher dia is 27 cm and length is 93 cm when rolled.
- Stretcher backbag sizes: 31 cm x 95 cm (Dia x Length),
stretcher sizes 27x 93 x 250 cm (Dia x Width x Length).

Weight : 8,4 kg
Standard: EN 1865
Color : Khaki

HARNESSES

LANYARDS &
SHOCK ABSORBERS

CARABINERS

PULLEYS

ASCENDERS

DESCENDERS

HELMETS

MOBILE FALL
ARRESTERS

RETRACTABLE
FALL ARRESTERS

RESCUE DEVICES

STRETCHERS

ROPES

BAGS AND
ACCESSORIES

SAFETY NETS

EDGE PROTECTION

TRIPOD AND
CANTILEVER ARMS

ANCHORAGES

HORIZONTAL
LIFELINE

VERTICAL LIFELINE

DEFENCE

LIFTING
EQUIPMENT



LUPA® FAST ROPE

- Material** : High Tenacity Mat Polyamide Fiber
- Construction** : 8 Strands
- Features** : Very Good Abrasion Resistance, High Durability
- Max. Elongation at Break:** % 59
- Density** : 1,14 kg/dm³
- Color** : Military Green/Desert Sand
- Standard** : MIL-F-44422
- Length** : 30 / 60 / 90 / 120 Feet Coil

SPIE ROPE

- Material** : Dyneema
- Construction** : 12 Strands
- Features** : Very Good Abrasion Resistance, UV Resistance, High Durability
- Density** : 1,14 kg/dm³
- Standard** : MIL-F-44422
- Length** : 34 mt
- Breaking Strength** : 20 mm – 38760 kgf, 10 mm – 10400 kgf





**LUPA®
STATIC 11 MM**

- Designed for rescue operations and rope access techniques.
- Made of High Tenacity Polyamide Fiber (S/Z Twist).
- Formed by core and protector cover.
- Excellent hand-grip feature.
- High resistance against abrasion.
- High UV resistance.
- Identification tape inserted (with information of relative standard, type of rope, brand).

Dia : 11 mm
Standard : EN 1891
Type : A
Weight : 78 gr/m
Breaking Strength : 28 kN
Breaking Strength with Knot: 19 kN
Static Stretching : % 2,7
Sheath Slippage : 0
Wet Tensile Strength : % 3,3
Knot Flexibility : 1
Stitched Eyes Strength : 25 kN
Eight Knot Strength : 16 kN

Standard Lengths
 • 50, 100, 150 & 200 Meter Plain Black



**LUPA®
ACCESSORY 7 MM**

- Designed for rescue operations, rope access techniques and difficult work environments.
- Made of High Tenacity Polyamide Fiber (S/Z Twist).
- Formed by core and protector cover.
- Excellent hand-grip feature.
- High resistance against abrasion.
- High UV resistance.
- Identification tape inserted (with information of relative standard, type of rope, brand).

Dia : 7 mm
Standard : EN 1891
Type : A
Weight : 32 gr/m
Breaking Strength : 13 kN
Breaking Strength with Knot: 7 kN
Wet Tensile Strength : % 3,3
Stitched Eyes Strength : 10 kN
Eight Knot Strength : 7,5 kN

Standard Lengths
 • 50, 100, 150 & 200 Meter Plain Black



**RG-20
ROPE GLOVE**

- Made of Neoprene with Kevlar reinforcement on palm and fingers.
- Convenient Velcro closure on the wrist for size adjustment.
- Ideal for water sports and yachting.

Size : S/M, L/XL
Weight: 105 gr

HARNESSES

LANYARDS &
SHOCK ABSORBERS

CARABINERS

PULLEYS

ASCENDERS

DESCENDERS

HELMETS

MOBILE FALL
ARRESTERS

RETRACTABLE
FALL ARRESTERS

RESCUE DEVICES

STRETCHERS

ROPES

BAGS AND
ACCESSORIES

SAFETY NETS

EDGE PROTECTION

TRIPOD AND
CANTILEVER ARMS

ANCHORAGES

HORIZONTAL
LIFELINE

VERTICAL LIFELINE

DEFENCE

LIFTING
EQUIPMENT



FRB-60
FAST ROPE BAG

- Designed to carry fast rope and technical equipment.
- Made of 1900 denier water proof fabric.
- 2 x shoulder pads.
- Carrying handles on both sides.
- 2 x AB-45 automatic buckles for releasing the rope and bag during operation.

Weight : 2 kg
Dia : 35 cm
Height : 60 cm
Volume: 57 L



BG-15
CARRYING BAGS

- Produced from high tenacity water proof cloth.
- Concealable back strap pads.
- Additional shoulder strap if needed.
- Material space separated with zipper.
- Wallet, Passport space.

Weight : 1.248 gr
Width : 30 cm
Length : 110 cm
Height : 45 cm
Volume: 58,5 L



MB-35

MATERIAL CARRYING BAG

- Two large, comfortable carrying handles.
- Adjustable strap for carrying bandolier style.
- Interior ring can be used as attachment point for rope.
- Waterproof fabric.
- Bag remains upright and has an exterior folding lid system that allows easy access to the contents of the bag.

Weight : 1.198 gr
Dia : 30 cm
Height : 54 cm
Volume: 38 L



MB-20

MB-10

MB-20

MATERIAL CARRYING BAG

- Two large, comfortable carrying handles.
- Adjustable strap for carrying bandolier style.
- Interior ring can be used as attachment point for rope.
- Waterproof fabric.
- Bag remains upright and has an exterior folding lid system that allows easy access to the contents of the bag.

Weight : 805 gr
Dia : 25 cm
Height : 40 cm
Volume: 20 L

MB-10

MATERIAL CARRYING BAG

- Two large, comfortable carrying handles.
- Adjustable strap for carrying bandolier style.
- Interior ring can be used as attachment point for rope.
- Waterproof fabric.
- Bag remains upright and has an exterior folding lid system that allows easy access to the contents of the bag.

Weight : 405 gr
Dia : 21 cm
Height : 30 cm
Volume: 10 L

HARNESSES

LANYARDS &
SHOCK ABSORBERS

CARABINERS

PULLEYS

ASCENDERS

DESCENDERS

HELMETS

MOBILE FALL
ARRESTERSRETRACTABLE
FALL ARRESTERS

RESCUE DEVICES

STRETCHERS

ROPES

BAGS AND
ACCESSORIES

SAFETY NETS

EDGE PROTECTION

TRIPOD AND
CANTILEVER ARMS

ANCHORAGES

HORIZONTAL
LIFELINE

VERTICAL LIFELINE

DEFENCE

LIFTING
EQUIPMENT



HSN-30

HELICOPTER SAFETY NET

- Special grey color that complies with ships.
- Specifically designed for navy and offshore helicopter landing deck in order to avoid any interference with helicopter operations and to prevent personnel falling overboard.
- Made of high tenacity webbing.
- Webbing is self-eyed, manufactured without stitching.
- Comes with same color of edge rope.

Standard: NATO & National Military Spec





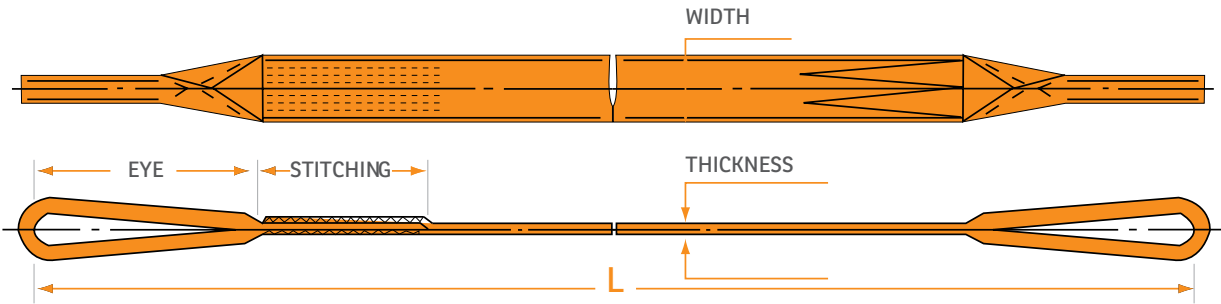

HEAVY DUTY POLYESTER EYE SLINGS

Made from high tenacity polyester webbing.

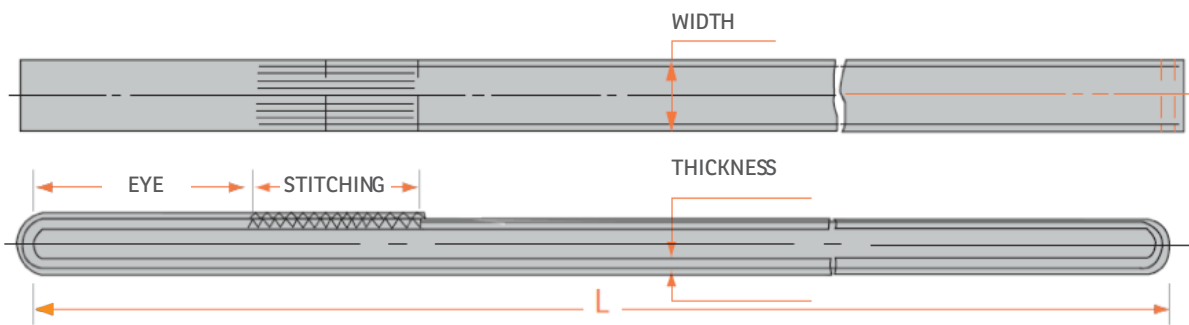

ENDLESS ROUND SLINGS

Polyester endless slings are constructed from multiple fiber polyester yarns enclosed in a tough two-ply woven tubular polyester jacket. This jacket protects the inner lifting fibers from wear, abrasion and exposure to other environmental conditions. All polyester endless round slings are color coated to indicated load capacity and come with a durable tag for easy identification.

HARNESSES

& LANYARDS
SHOCK ABSORBERS

CARABINERS

PULLEYS

ASCENDERS

DESCENDERS

HELMETS

MOBILE FALL
ARRESTERS

RETRACTABLE
FALL ARRESTERS

RESCUE DEVICES

STRETCHERS

ROPES

BAGS AND
ACCESSORIES

SAFETY NETS

EDGE PROTECTION

TRIPOD AND
CANTILEVER ARMS

ANCHORAGES

HORIZONTAL
LIFELINE

VERTICAL LIFELINE

DEFENCE



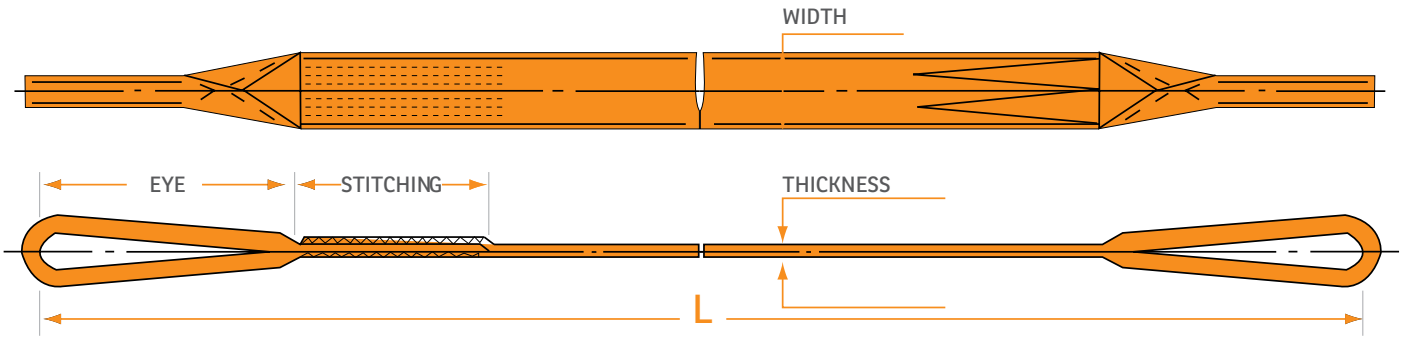

**LIFTING
EQUIPMENT**



FEATURES

Material : % 100 Polyester
Standard : EN 1492-1+A1:2010
Safety Factor: 7:1

- Made from high tenacity polyester webbing.
- Available in various sizes and rating capacities.
- Capacities are color coded.
- Sold in HOOK brand.
- HOOK is the registered trademark of Kaya Group.

									
	WIDTH (MM)	WORKING LOAD (KG 100 %)	WORKING LOAD (KG 80 %)	WORKING LOAD (KG 200 %)	ANGLE (0-45°) WORKING LOAD (KG)	ANGLE (45-60°) WORKING LOAD (KG)	BREAKING LOAD (KG)	WORKING LOAD (KG)	LENGTH (MT)
PURPLE	30-50	1000	800	2000	1400	1000	7000	1000	1-10
GREEN	70	2000	1600	4000	2800	2000	14000	2000	2-10
YELLOW	90	3000	2400	6000	4200	3000	21000	3000	2-10
GREY	120	4000	3200	8000	5600	4000	28000	4000	4-10
RED	150	5000	4000	10000	7000	5000	35000	5000	4-10
BROWN	180	6000	4800	12000	8400	6000	42000	6000	4-10
BLUE	250	8000	6400	16000	11200	8000	56000	8000	5-10
ORANGE	300	10000	8000	20000	14000	10000	70000	10000	5-10

-  1. FLAT EYE
-  2. REVERSE EYE
-  3. ONE SIDE IS ½ CLOSED EYE
-  4. TWO SIDE ARE ½ CLOSED EYE
-  5. ⅓ CLOSED EYE

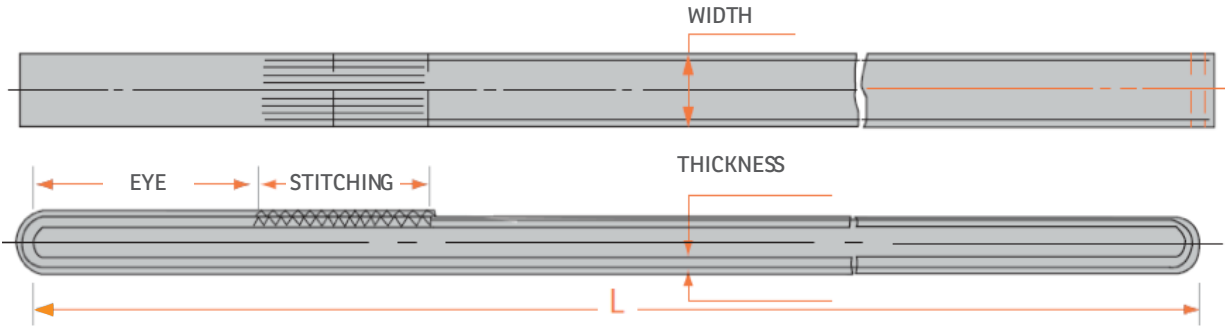

ENDLESS ROUND SLINGS





Polyester endless slings are constructed from multiple fiber polyester yarns enclosed in a tough two-ply woven tubular polyester jacket. This jacket protects the inner lifting fibers from wear, abrasion and exposure to other environmental conditions. All polyester endless round slings are color coated to indicated load capacity and come with a durable tag for easy identification.

FEATURES

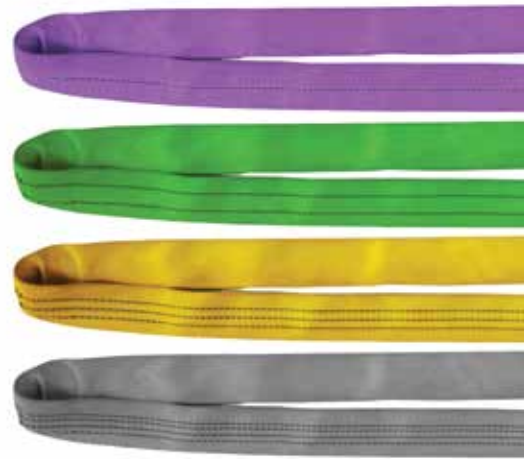
- Material** : % 100 Polyester
- Standard** : EN 1492-1+A1:2010
- Safety Factor**: 7:1

- Made from high tenacity polyester webbing.
- Available in various sizes and rating capacities.
- Capacities are color coded.
- Sold in HOOK brand.
- HOOK is the registered trademark of Kaya Group.



									
	WIDTH (MM)	WORKING LOAD (KG 100 %)	WORKING LOAD (KG 80 %)	WORKING LOAD (KG 200 %)	ANGLE (0-45°) WORKING LOAD (KG)	ANGLE (45-60°) WORKING LOAD (KG)	BREAKING LOAD (KG)	WORKING LOAD (KG)	LENGTH (MT)
PURPLE	30-50	1000	800	2000	1400	1000	7000	1000	1-10
GREEN	70	2000	1600	4000	2800	2000	14000	2000	2-10
YELLOW	90	3000	2400	6000	4200	3000	21000	3000	2-10
GREY	120	4000	3200	8000	5600	4000	28000	4000	4-10
RED	150	5000	4000	10000	7000	5000	35000	5000	4-10
BROWN	180	6000	4800	12000	8400	6000	42000	6000	4-10
BLUE	250	8000	6400	16000	11200	8000	56000	8000	5-10
ORANGE	300	10000	8000	20000	14000	10000	70000	10000	5-10

HARNESSES

& LANYARDS
SHOCK ABSORBERS

CARABINERS

PULLEYS

ASCENDERS

DESCENDERS

HELMETS

MOBILE FALL
ARRESTERS

RETRACTABLE
FALL ARRESTERS

RESCUE DEVICES

STRETCHERS

ROPES

BAGS AND
ACCESSORIES

SAFETY NETS

EDGE PROTECTION

TRIPOD AND
CANTILEVER ARMS

ANCHORAGES

HORIZONTAL
LIFELINE

VERTICAL LIFELINE

DEFENCE

LIFTING
EQUIPMENT



HARNESSES

LANYARDS &
SHOCK ABSORBERS

CARABINERS &
ASCENDERS

HELMETS

MOBILE FALL
ARRESTERS

RETRACTABLE
FALL ARRESTERS
AND BAGS

STRETCHERS

TRIPOD AND
CANTILEVER ARMS

HORIZONTAL
LIFELINES

VERTICAL
LIFELINES



R-5 A FALL ARREST AND WORK POSITIONING HARNESS

- Designed for fall arrest, rope access, restraint, work positioning, climbing, control descent and rescue purposes.
- Has 5 attachment points;
1 x Dorsal and 1 Sternal D - Ring for Fall Arrest.
1 x Ventral D - Ring at waist level for Rope Access work.
2 x Lateral D - Rings for Work Positioning.
- Includes fall indicators on the sternal and dorsal attachment points. If a fall indicator is visible after a fall, the harness must be retired.
- Suspension leg straps allows for increased comfort.
- Maximum comfort by breathing, antibacterial and ergonomic waist, leg and shoulder pads.
- Easy use aluminum automatic buckles on legs for fast connection and release.
- Easy use steel buckles on waist and shoulder.
- UV resistant high strength bonded type sewing yarns and contrastive color sewing in CNC machineries for quick eye control.
- 4 gear loops on waist pad.
- The protective case protects the information tag visually and enables users to log annual inspections.
- Equipped with suspension trauma straps to overcome the potential negative health impacts of suspension trauma.

Size : S/M, L/XL, XXL
Standard: EN 361, EN 358, EN 813, EN 12277



R-5 FALL ARREST AND WORK POSITIONING HARNESS

- Designed for fall arrest, rope access, restraint, work positioning, climbing, control descent and rescue purposes.
- Has 5 attachment points;
1 x Dorsal and 1 Sternal D - Ring for Fall Arrest.
1 x Ventral D - Ring at waist level for Rope Access work.
2 x Lateral D - Rings for Work Positioning.
- Includes fall indicators on the sternal and dorsal attachment points. If a fall indicator is visible after a fall, the harness must be retired.
- Suspension leg straps allows for increased comfort.
- Maximum comfort by breathing, antibacterial and ergonomic waist, leg and shoulder pads.
- Easy use steel buckles on waist, shoulder and legs.
- UV resistant high strength bonded type sewing yarns and contrastive color sewing in CNC machineries for quick eye control.
- 4 gear loops on waist pad.
- The protective case protects the information tag visually and enables users to log annual inspections.
- Equipped with suspension trauma straps to overcome the potential negative health impacts of suspension trauma.

Size : S/M, L/XL, XXL
Standard: EN 361, EN 358, EN 813, EN 12277



P-453 Y
FALL ARREST AND
WORK POSITIONING HARNESS

- Designed for fall arrest, restraint and work positioning purposes.
- Has 4 attachment points;
 1 x Dorsal D – Ring for Fall Arrest.
 1 x Ventral D - Ring at waist level for Rope Access work.
 2 x Lateral D - Rings for Work Positioning.
- Ergonomic waist, leg and shoulder pads.
- Easy use steel buckles on waist and shoulder.
- UV resistant high strength bonded type sewing yarns and contrastive color sewing in CNC machineries for quick eye control.
- 2 gear loops on waist pad.

Size : S/M, L/XL, XXL
Standard: EN 361, EN 358, EN 813



P-3
FALL ARREST AND
WORK POSITIONING HARNESSSES

- Designed for fall arrest, restraint and work positioning purposes.
- Has 4 attachment points;
 1 x Dorsal
 1 x Sternal
 2 x Lateral
- Ergonomic waist pad.
- Easy use steel buckles.
- UV resistant high strength bonded type sewing yarns and contrastive color sewing in CNC machineries for quick eye control.
- 2 gear loops on waist pad.

Size : S/M, L/XL, XXL
Standard: EN 361, EN 358



P-453 C
FALL ARREST AND
WORK POSITIONING HARNESSSES

- Designed for fall arrest, restraint and work positioning purposes.
- Has 3 attachment points;
 1 x Dorsal D – Ring for Fall Arrest
 2 x Lateral D - Rings for Work Positioning.
- Ergonomic waist pad.
- Easy use steel buckles.
- UV resistant high strength bonded type sewing yarns and contrastive color sewing in CNC machineries for quick eye control.
- 2 gear loops on waist pad.

Size : S/M, L/XL, XXL
Standard: EN 361, EN 358

HARNESSES

LANYARDS & SHOCK ABSORBERS

CARABINERS & ASCENDERS

HELMETS

MOBILE FALL ARRESTERS

RETRACTABLE FALL ARRESTERS AND BAGS

STRETCHERS

TRIPOD AND CANTILEVER ARMS

HORIZONTAL LIFELINES

VERTICAL LIFELINES



B-2
FALL ARREST HARNESS

- Designed for fall arrest purpose.
- 1 x Dorsal D – Ring for Fall Arrest.
- Easy use steel buckles.
- UV resistant high strength bonded type sewing yarns and contrastive color sewing in CNC machineries for quick eye control.

Size : S/M, L/XL, XXL
Standard: EN 361



P-1 C
FALL ARREST HARNESS

- Designed for fall arrest purpose.
- 1 x Dorsal D – Ring for Fall Arrest.
- Easy use steel buckles.
- UV resistant high strength bonded type sewing yarns and contrastive color sewing in CNC machineries for quick eye control.

Size : S/M, L/XL, XXL
Standard: EN 361



P-451 AS
ANTI-STATIC FALL ARREST HARNESS

- Designed for fall arrest purpose.
- Ideal solution for safe work at height in explosive atmospheres.
- Suitable for Petrochemical and Mining Industry Environments.
- The Anti-static material prevents the risk of an electrostatic discharge igniting the explosive atmosphere thus allowing the user to work in complete safety in these high-risk environments.
- 1 x Dorsal D – Ring for Fall Arrest.
- 2 x A/2 sternal connection point with oval shape carabiner.
- Easy use steel buckles.
- UV resistant high strength bonded type sewing yarns and contrastive color sewing in CNC machineries for quick eye control.

Size : S/M, L/XL, XXL
Standard: EN 361, EN 13463-1





B-452

WORK POSITIONING BELT (WAIST TYPE)

- Designed for restraint and work positioning purposes.
- 2 x Lateral D - Rings for Work Positioning.
- Maximum comfort by breathing, antibacterial and ergonomic waist pad.
- SS316 buckles.

Size : S/M, L/XL

Standard: EN 358



AK-25



AK-85

AK-25

WEIGHT LIFTING BELT WITH SHOULDER STRAP

- Designed to prevent injury to the low back during heavy lifts.
- 85 mm high tenacity webbing.
- Adjustable shoulder straps allows comfortable wear.

Size : S/M, L/XL

Weight : 256 gr

Standard: ISO 9001:2008

AK-85









WEIGHT LIFTING BELT

- Designed to prevent injury to the low back during heavy lifts.
- 85 mm high tenacity webbing.
- Velcro straps allows easy wear and size adjustment.

Size : S/M, L/XL

Weight : 435 gr

Standard: ISO 9001:2008

IMAGE	PRODUCT CODE	SIZE	STANDARD	ANCHORAGE POINT				DIMENSIONS			WEIGHT
				BACK (EN 361)	CHEST (EN 361)	SIDE (EN 358)	ABDOMINAL (EN 813)	WAIST	LEG	LENGTH	
	R-5 A	S/M	EN 361	√	√	√	√	65 - 95 cm	45 - 65 cm	155 - 175 cm	1,795 kg
		L/XL	EN 358	√	√	√	√	75 - 115 cm	60 - 70 cm	175 - 190 cm	1,885 kg
		XL/XXL	EN 813	√	√	√	√	85 - 135 cm	65 - 80 cm	180 - 200 cm	1,975 kg
	R-5	S/M	EN 361	√	√	√	√	65 - 95 cm	45 - 65 cm	155 - 175 cm	1,662 kg
		L/XL	EN 358	√	√	√	√	75 - 115 cm	60 - 70 cm	175 - 190 cm	1,752 kg
		XL/XXL	EN 813	√	√	√	√	85 - 135 cm	65 - 80 cm	180 - 200 cm	1,842 kg
	P-453 Y	S/M	EN 361	√	√	√	√	65 - 95 cm	45 - 65 cm	155 - 175 cm	1,790 kg
		L/XL	EN 358	√	√	√	√	75 - 115 cm	60 - 70 cm	175 - 190 cm	1,880 kg
		XL/XXL	EN 813	√	√	√	√	85 - 135 cm	65 - 80 cm	180 - 200 cm	1,970 kg
	P-3	S/M	EN 361 EN 358	√	√	√	-	65 - 95 cm	45 - 65 cm	155 - 175 cm	1,390 kg
		L/XL		√	√	√	-	75 - 115 cm	60 - 70 cm	175 - 190 cm	1,480 kg
		XL/XXL		√	√	√	-	85 - 135 cm	65 - 80 cm	180 - 200 cm	1,550 kg
	P-453 C	S/M	EN 361 EN 358	√	-	√	-	65 - 95 cm	45 - 65 cm	155 - 175 cm	1,170 kg
		L/XL		√	-	√	-	75 - 115 cm	60 - 70 cm	175 - 190 cm	1,260 kg
		XL/XXL		√	-	√	-	85 - 135 cm	65 - 80 cm	180 - 200 cm	1,350 kg
	B-2	S/M	EN 361	√	√	-	-	-	60 - 70 cm	155 - 175 cm	0,895 kg
		L/XL		√	√	-	-	-	45 - 65 cm	175 - 190 cm	0,983 kg
		XL/XXL		√	√	-	-	-	65 - 80 cm	180 - 200 cm	1,070 kg
	P-1 C	S/M	EN 361	√	-	-	-	-	45 - 65 cm	155 - 175 cm	0,705 kg
		L/XL		√	-	-	-	-	60 - 70 cm	175 - 190 cm	0,767 kg
		XL/XXL		√	-	-	-	-	65 - 80 cm	180 - 200 cm	0,810 kg
	P-451 AS	S/M	EN 361 EN 13463-1	√	√	-	-	-	45 - 65 cm	155 - 175 cm	0,875 kg
		L/XL		√	√	-	-	-	60 - 70 cm	175 - 190 cm	0,941 kg
		XXL		√	√	-	-	-	65 - 80 cm	180 - 200 cm	1,050 kg
	B-452	S/M	EN 358	-	-	√	-	65 - 95 cm	65 - 95 cm	45 - 65 cm	0,477 kg
		L/XL		-	-	√	-	75 - 115 cm	60 - 70 cm	175 - 190 cm	0,519 kg



HARNESSES

LANYARDS & SHOCK ABSORBERS

CARABINERS & ASCENDERS

HELMETS

MOBILE FALL ARRESTERS

RETRACTABLE FALL ARRESTERS AND BAGS

STRETCHERS

TRIPOD AND CANTILEVER ARMS

HORIZONTAL LIFELINES

VERTICAL LIFELINES



RAWL-1 SINGLE – LEG SHOCK ABSORBING LANYARD

- Allows workers to attach to an anchorage point and remain safe during their work.
- Made of highly resistant 45mm polyester webbing.
- Built-in energy absorber limits the fall arrest force in a fall situation by tearing specific seams.
- Clear PVC case to protect the energy absorber.
- Stitched in professional CNC machines by bonded type UV and dust resistant high tenacity yarn.

Length : 1.2, 1.5 & 2 m
Standard: EN 355, EN 362
Weight : 1.090 gr (1.2 m)

RAWL-2 DOUBLE – LEG SHOCK ABSORBING LANYARD

- Twin-leg model allows user to keep one leg attached to the anchorage while the other leg is always ready to be hooked to the next anchorage.
- Made of highly resistant 45 mm polyester webbing.
- Built-in energy absorber limits the fall arrest force in a fall situation by tearing specific seams.
- Clear PVC case to protect the energy absorber.
- Stitched in professional CNC machines by bonded type UV and dust resistant high tenacity yarn.

Length : 1.2, 1.5 & 2 m
Standard: EN 355, EN 362
Weight : 1.640 gr (1.2 m)

ROLW-1 SINGLE LEG LANYARD

- Allows workers to attach to an anchorage point and remain safe during their work.
- Made of highly resistant polyester webbing.
- Stitched in professional CNC machines by bonded type UV and dust resistant high tenacity yarn.

Length : 1.2, 1.5 & 2 m
Standard: EN 354
Weight : 149 gr (1.8 m)



ROL-1 SINGLE LEG LANYARD

- Allows workers to attach to an anchorage point and remain safe during their work.
- Made of high tenacity 3 strands braided rope.

Length : 1,2, 1,5 & 2 m
Standard: EN 354
Weight : 312 gr (1.8 m)



RARL-1 SINGLE - LEG SHOCK ABSORBING LANYARD

- Made of high tenacity 3 strands twisted rope.
- Allows workers to attach to an anchorage point and remain safe during their work.
- Built-in energy absorber limits the fall arrest force in a fall situation by tearing specific seams.
- Clear PVC case to protect the energy absorber.

Length : 1,2, 1,5 & 2 m
Standard: EN 355, EN 362
Weight : 1.200 gr (1.2 m)



RARL-2 DOUBLE LEG SHOCK ABSORBING LANYARD

- Made of high tenacity 3 strands twisted rope.
- Twin-leg model allows user to keep one leg attached to the anchorage while the other leg is always ready to be hooked to the next anchorage.
- Built-in energy absorber limits the fall arrest force in a fall situation by tearing specific seams.
- Clear PVC case to protect the energy absorber.

Length : 1,2 - 1,5 & 2 m
Standard: EN 355, EN 362
Weight : 1.880 gr (1.2 m)

CARABINER OPTIONS



ROC-1

ROC-2



RA-7
SHOCK ABSORBER

- Built-in energy absorber limits the fall arrest force in a fall situation by tearing specific seams.
- Stitched in professional CNC machines by bonded type UV and dust resistant high tenacity yarn.
- Clear PVC case to protect the energy absorber.

Folded Length : 30 cm
Unfolded Length: 150 cm
Standard : EN 355
Weight : 215 gr/mt

CARABINER OPTIONS



ROC-1 ROC-2

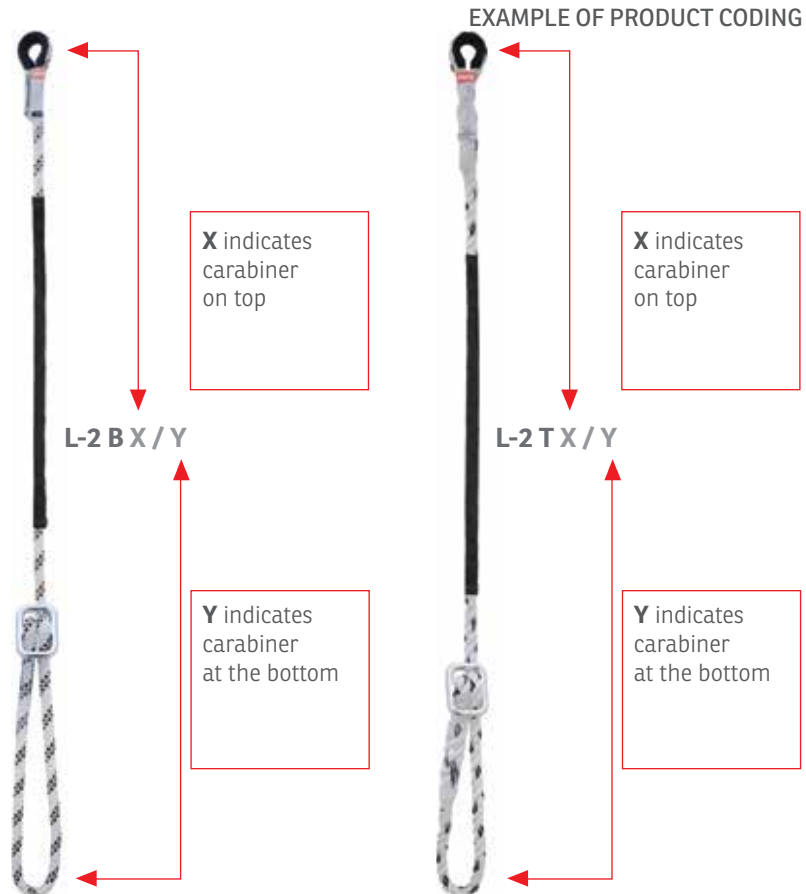

L-2 B
SINGLE – LEG ADJUSTABLE
BRAIDED ROPE LANYARD

- Allows workers to attach to an anchorage point and remain safe during their work.
- Can be used as work positioning lanyard thanks to its ability to be adjusted.
- Allows workers to attach to an anchorage point and remain safe during their work.
- Stitched in professional CNC machines by bonded type UV and dust resistant high tenacity yarn.

Length : 1, 2 & 2 meter
Standard: EN 354, EN 362, EN 12275

L-2 T
SINGLE – LEG ADJUSTABLE
TWISTED ROPE LANYARD

- Made of high tenacity 3 strands twisted rope.
- Can be used as work positioning lanyard thanks to its ability to be adjusted.
- Allows workers to attach to an anchorage point and remain safe during their work.

Length : 1, 2 & 2 meter
Standard: EN 354, EN 362, EN 12275

HARNESSES

LANYARDS & SHOCK ABSORBERS

CARABINERS & ASCENDERS

HELMETS

MOBILE FALL ARRESTERS

RETRACTABLE FALL ARRESTERS AND BAGS

STRETCHERS

TRIPOD AND CANTILEVER ARMS

HORIZONTAL LIFELINES

VERTICAL LIFELINES



ROC-1



ROC-2



ROC-1

OVAL SHAPED STEEL CARABINER

- Designed for difficult working environments.
- Oval shape allows multi-purpose use.
- Galvanized Steel Material.

Strength : 23 kN
Gate Opening: 16 mm
Standard : EN 362
Weight : 165 gr

ROC-2

LARGE DOUBLE SAFETY CARABINER

- Large size and wide gate opening facilitate use on large metallic structures.
- Galvanized Steel Material.
- Double Locking.

Strength : 23 kN
Gate Opening: 51 mm
Standard : EN 362
Weight : 508 gr

RL-41

WOOD STEPS ROPE LADDER

- Knotless montage thanks to the 3 pieces of holes on steps.
- Made of high tenacity 12 mm braided polyester rope.
- Steps are made of wood and spaced in 40 x 40 cm increments.

Length: Produced in desired length.
Weight: 1.250 gr/m



RL-40
ROPE LADDER

- Made of EN ISO 1261 standard, 3 strands 16 mm sisal rope.
- Steps are made of wood and spaced in 40 x 40 cm increments.

Length: Produced in desired length.
Weight: 1.100 gr/m



RL-41A
ALUMINUM STEPS ROPE LADDER

- Knotless montage thanks to the 3 pieces of holes on steps.
- Made of high tenacity 12 mm braided polyester rope.
- Steps are made of aluminum and spaced in 40 x 40 cm increments.

Length: Produced in desired length.
Weight: 1250 gr/m

HARNESSES

LANYARDS &
SHOCK ABSORBERS

CARABINERS &
ASCENDERS

HELMETS

MOBILE FALL
ARRESTERS

RETRACTABLE
FALL ARRESTERS
AND BAGS

STRETCHERS

TRIPOD AND
CANTILEVER ARMS

HORIZONTAL
LIFELINES

VERTICAL
LIFELINES





HARNESSES

LANYARDS & SHOCK ABSORBERS

CARABINERS & ASCENDERS

HELMETS

MOBILE FALL ARRESTERS

RETRACTABLE FALL ARRESTERS AND BAGS

STRETCHERS

TRIPOD AND CANTILEVER ARMS

HORIZONTAL LIFELINES

VERTICAL LIFELINES

H-13 ISLAND INDUSTRIAL HELMET

- It is ideal for rescue operation and works at height.
- Slots for ear protectors fixing.
- Adjustable and removable chinstrap.
- Ventilation with 2 vents.

Color : Red, White, Blue
Size : 54/62 cm (Adjustable)
Weight : 400 gr
Outer shell: Thermo ABS
Inner shell : High Tenacity polystyrene EPS foam
Standard : EN 397

H-12 SUMMIT MOUNTAINEERING HELMET

- Ideal for ski-mountaineering and climbing.
- Adjustable and removable chinstrap.
- Ventilation with 8 vents.

Color : Red, White, Blue
Size : 55/62 cm (Adjustable)
Weight : 410 gr
Outer shell: Thermo ABS
Inner shell : High Tenacity polystyrene EPS foam
Standard : EN 12492

ACCESSORIES



SHORT VISOR



LONG VISOR



VISOR+EAR MUFFS



F-2 A/B

ROPE GRAB

- Enables users move up and down safely on mobile vertical lifelines.
- Used as personal fall-restraint system on roof tops.

Ürün Tipleri

F-2A

Material : Steel

Rope Dia : 16 mm

Weight : 460 gr

Standard: EN 353-2

F-2B

Material : Steel

Rope Dia : 12 mm

Weight : 420 gr

Standard: EN 353-2

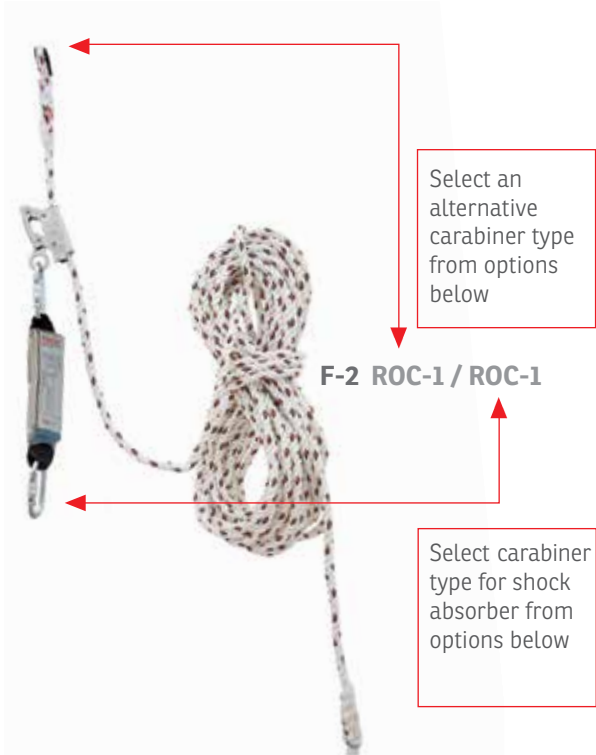

F-2
FALL ARRESTER SYSTEM WITH ROPE GRAB

- Used for work restraint.
- Used as secondary safety purposes.
- Rope is tested and certificated according to EN 353-2.
- Energy absorber (RA-7) designed to limit the impact transmitted to the user in case of a fall.

Rope Dia : Ø 16 mm
Standard: EN 353-2

CARABINER OPTIONS



HARNESSES

LANYARDS & SHOCK ABSORBERS

CARABINERS & ASCENDERS

HELMETS

MOBILE FALL ARRESTERS

RETRACTABLE FALL ARRESTERS AND BAGS

STRETCHERS

TRIPOD AND CANTILEVER ARMS

HORIZONTAL LIFELINES

VERTICAL LIFELINES



BG-06 CARRYING BAG

- Special design for carrying work at height equipment.
- Produced from high tenacity PES canvas.
- 45 mm polyester shoulder straps.

Weight : 548 gr
Dia : 30 cm
Height : 50 cm
Volume: 35L



RETRAC-AS 2,1



RETRAC-2,5

RETRAC-AS 2,1 RETRACTABLE FALL ARRESTER

- Can be used as shock absorbing webbing lanyard.
- Locks automatically to prevent a fall.

Length : 2,1 m
Weight : 1,25 kg
Standard: EN 360

RETRAC-2,5 RETRACTABLE FALL ARRESTER

- Can be used as shock absorbing webbing lanyard.
- Locks automatically to prevent a fall.

Length : 2,5 m
Weight : 1,15 kg
Standard: EN 360



RETRAC PS-3,3

RETRAC PS-6

RETRAC PS-12

RETRAC PS-19

RETRAC PS-23

RETRAC PS SERIES

RETRACTABLE FALL ARRESTERS

- Incorporated with 4,7 mm high tenacity galvanized wire rope.
- Gives greater working distances from the anchorage point.
- Incorporates self-locking function and automatic tensioning system.
- Retractable wire rope system.
- High strength PE housing.
- Anchorage eye with swivel action prevents undue twist of rope while working or on the event of a fall.

Standard: EN 360

Retrac Types;

RETRAC PS-3,3

Length: 3,3 mt

Weight: 2,3 kg

RETRAC PS-6

Length: 6 mt

Weight: 3,0 kg

RETRAC PS-12

Length: 12 mt

Weight: 5,8 kg

RETRAC PS-19

Length: 19 mt

Weight: 7,7 kg

RETRAC PS-23

Length: 23 mt

Weight: 9,0 kg



HARNESSES

LANYARDS &
SHOCK ABSORBERS

CARABINERS &
ASCENDERS

HELMETS

MOBILE FALL
ARRESTERS

RETRACTABLE
FALL ARRESTERS
AND BAGS

STRETCHERS

TRIPOD AND
CANTILEVER ARMS

HORIZONTAL
LIFELINES

VERTICAL
LIFELINES



RS-260 BASKET STRETCHER

- Made entirely from Monoblock steel profile with TIG welding chassis.
- Black mat electrostatic paint on cataphoresis primer.
- Compact laminate floor covering.
- Shaped to accommodate an adult in a face up position.
- Used in search & rescue operations.
- Ideal for lifting and transporting by helicopter.
- Supports four point bridle (optional).

Material	: Steel (oven-drying)
Carrying Capacity	: 300 kg
Width	: 209 cm
Length	: 60 cm
Height	: 20 cm
Weight	: 12 kg
Standard	: EN 1865



RL-4 A BASKET STRETCHER

- Shaped to accommodate an adult in a face up position.
- Used in search & rescue operations.
- Ideal for lifting and transporting by helicopter.
- Supports four point bridle (optional).

Material	: Steel (oven-drying)
Carrying Capacity	: 200 kg
Carrying Strength	: 22 kN
Width	: 64 cm
Length	: 204 cm
Height	: 24 cm
Weight	: 12 kg

HARNESSES

LANYARDS & SHOCK ABSORBERS

CARABINERS & ASCENDERS

HELMETS

MOBILE FALL ARRESTERS

RETRACTABLE FALL ARRESTERS AND BAGS

STRETCHERS

TRIPOD AND CANTILEVER ARMS

HORIZONTAL LIFELINES

VERTICAL LIFELINES



RL-1



RL-2



RL-3



RL-4 E

RL-1

FOLDING POLE STRETCHER

- Very easy to carry and practical.
- Aluminum alloy poles and hinged cross spreaders which provide strength and durability.
- Poles constructed of high quality aluminum alloy.
- Fire retardant, friction and tear resistant 1100 denier Polyester / PVC fabric.
- Folding into half its length for convenient storage.

Carrying Capacity: 150 kg
Width : 55 cm
Length : 210 cm
Height : 13 cm
Weight : 6,0 kg
Standard : EN 1865

RL-2

FOLDING POLE STRETCHER

- Folds in both length & width to an extremely compact size.
- Poles constructed from lightweight aluminum for easy lifting.

Carrying Capacity: 150 kg
Width : 55 cm
Length : 210 cm
Height : 13 cm
Weight : 6,5 kg
Standard : EN 1865

RL-3

FOLDING POLE STRETCHER

- Poles constructed of high quality aluminum alloy.
- Fire retardant, friction and tear resistant 1100 denier Polyester / PVC fabric.

Carrying Capacity: 170 kg
Width : 55 cm
Length : 210 cm
Height : 13 cm
Weight : 4,7 kg
Standard : EN 1865

RL-4 E

FOUR POINT BRIDLE FOR BASKET STRETCHERS

- Made of 45 mm high tenacity polyester webbing.
- Adjustable legs.
- Carrying rings (10 kN).
- 4 x K-2 model karabiner (28 kN, EN 362).
- High tenacity bounded type UV and dust resistant sewing yarn.
- Suitable to use with RL-4 and RL-4A model stretchers.



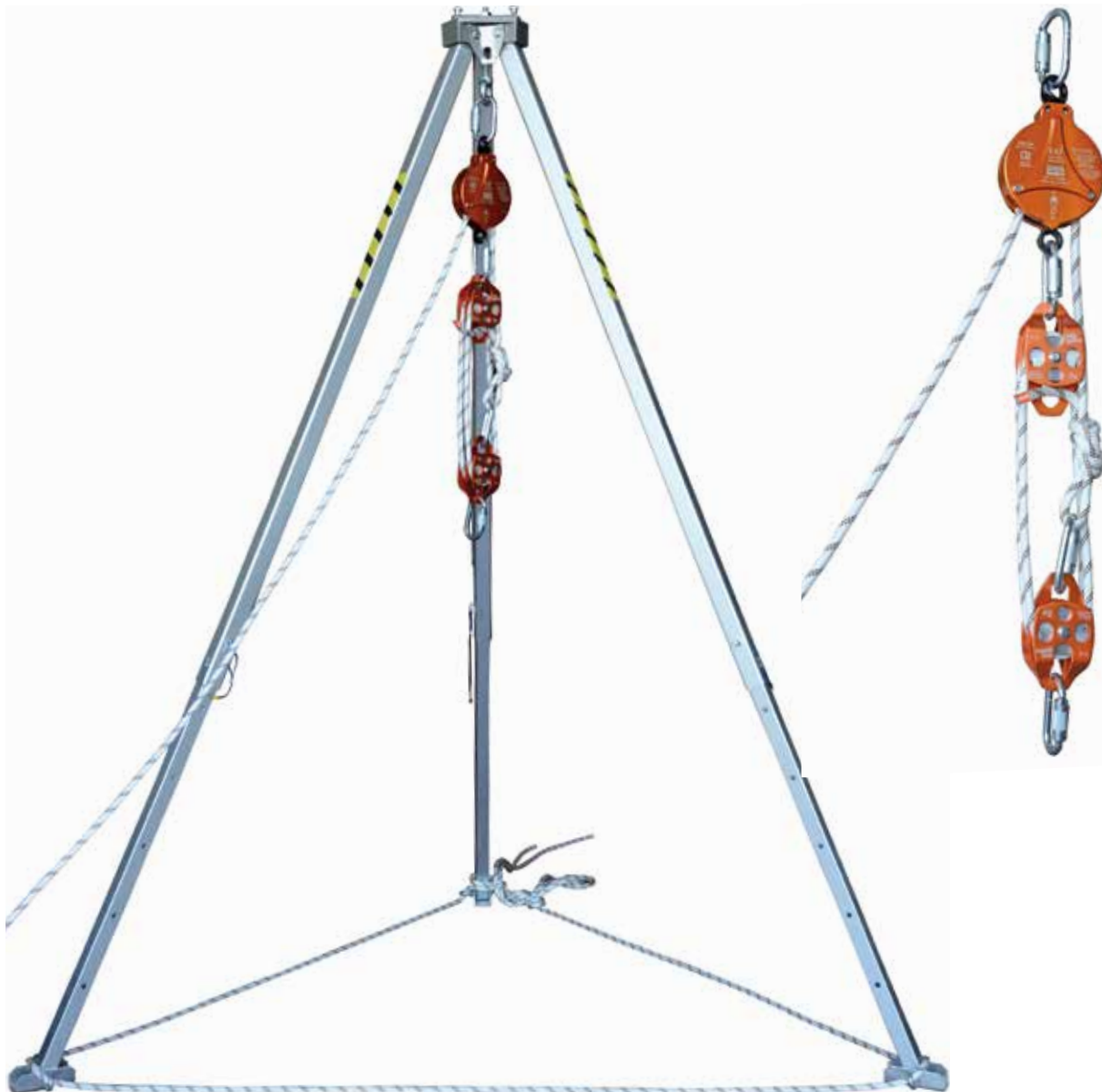

HARNESSES

LANYARDS & SHOCK ABSORBERS

CARABINERS & ASCENDERS

HELMETS

MOBILE FALL ARRESTERS

RETRACTABLE FALL ARRESTERS AND BAGS

STRETCHERS

TRIPOD AND CANTILEVER ARMS

HORIZONTAL LIFELINES

VERTICAL LIFELINES

R-ALF

CONFINED SPACE RESCUE SYSTEM WITH RESCUE PULLEY

R-ALF rescue pulley is used as part of work suspension system either in confined spaces as a user can easily lift/lower themselves. If the user loses control of the decent the over speed brake will automatically kick in. 11 mm static rope is recommended and the length static rope varies depending on the depth of confined space.

Carrying Capacity: 300 kg

System Components;

- T-150 Tripod (T-150 A or T-150 B)
- R-ALF rescue pulley
- P-5 Pulley (EN12278)
- K-2 / 3A Carabiner x 4 (EN 362)
- Ø 11 mm static rope (EN 1891)



T-150 A TRIPOD

- High functional stability, load-carrying capacity max. 2 persons.
- Equipped with foldable rubber feet for high stability in various substrates.
- Light aluminum construction.
- Adjustable legs with integral push pins.
- Corrosion-resistant coating.
- 300 kg loading capacity.

Standard: EN 795- Class B

	Closed	Open
Height (h)	: 149 cm	249 cm
Length (L)	: 156 cm	263 cm
Ground Dia (Ø):	92 cm	148 cm



T-150 TRIPOD ALKO WINCH MOUNTING BRACKET

Length: 9,5-24 m
30-42 m



T-150 TRIPOD HRA MOUNTING BRACKET



HRA
CONFINED SPACE RESCUE SYSTEM WITH HRA

HRA Fall Arrester Block is used in conjunction with aluminum tripods to protect the user when ascending and descending a vertical shaft. Recovery Mechanism allows the device to be used to lift or lower a casualty post fall, or if they have become incapacitated in a confined space.

- System Components;**
- T-150 Tripod (T-150 A or T-150 B)
 - HRA Fall Arrester Device
 - T-150 HRA Mounting Bracket
 - K-14 / 3A Carabiner x 1
 - P-11 SS Pulley x 1
 - Tripod bag



HRA & ALKO
CONFINED SPACE RESCUE SYSTEM WITH HRA & ALKO HAND WINCH

Manually operated ALKO Hand Winch may also be used if secondary safety is needed.

- System Components;**
- T-150 Tripod (T-150 A or T-150 B)
 - HRA Fall Arrester Device
 - T-150 HRA Mounting Bracket
 - ALKO 651 Hand Winch
 - T-150 ALKO Winch Mounting Bracket
 - K-14 / 3A carabiner x 1
 - P-11 SS Pulley x 1
 - Tripod bag

HARNESSES

LANYARDS & SHOCK ABSORBERS

CARABINERS & ASCENDERS

HELMETS

MOBILE FALL ARRESTERS

RETRACTABLE FALL ARRESTERS AND BAGS

STRETCHERS

TRIPOD AND CANTILEVER ARMS

HORIZONTAL LIFELINES

VERTICAL LIFELINES



HARNESSES

LANYARDS &
SHOCK ABSORBERS

CARABINERS &
ASCENDERS

HELMETS

MOBILE FALL
ARRESTERS

RETRACTABLE
FALL ARRESTERS
AND BAGS

STRETCHERS

TRIPOD AND
CANTILEVER ARMS

HORIZONTAL
LIFELINES

VERTICAL
LIFELINES

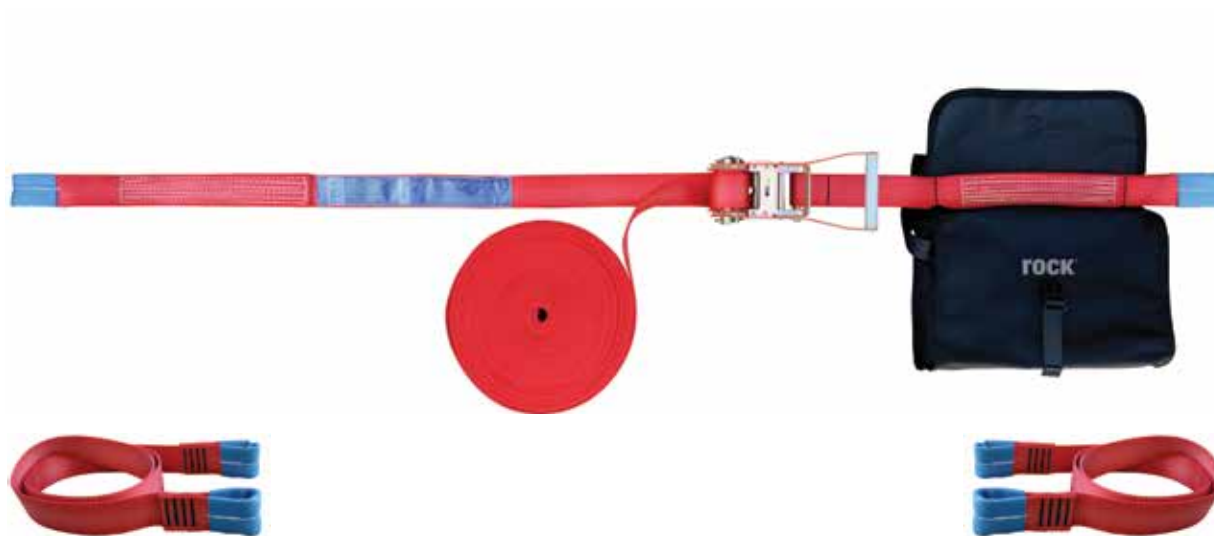

RMHL MOBILE LIFELINE

- Easy to assemble.
- Adjustable length (4-20 mt).
- Certified to be used by 3 people at once.
- Provided with 2 x Anchor sling.

Standard: EN 795:2012 Type C, CEN/TS 16415:2013 Type C



RVL-100

VERTICAL LIFELINE WITH INTEGRATED SHOCK ABSORBER

- Made of galvanized steel.
- The top mounting bracket incorporates a shock absorber, further reducing impact force on the worker and the structure.
- Brackets are designed for ladder rungs but can be easily adapted to most structures.
- Tension indicator ensures proper tensioning of the system during installation.
- Sold as a complete system.

System Components

- RP-300A Top anchorage bracket
- RP-300B Bottom anchorage bracket
- RA-50 Shock absorber
- RS-40 Turnbuckle & Indicator
- RC-30V Rope Guide
- RL-110 Wire rope

Note: System must be used only with F-5 Rope Grab.

Length : From 3 mt to desired length.

Standard: EN 353-1:2014



F-5

WIRE ROPE GRAB (FALL ARRESTER)

- Made of Stainless Steel.
- It is secured with a K-2/3ACP carabiner. Use of non-authorized carabiner can cause fatal accidents.
- The user is free to climb and descend with full use of the hands.

Standard: EN 353-1:2014

HARNESSES

LANYARDS &
SHOCK ABSORBERS

CARABINERS &
ASCENDERS

HELMETS

MOBILE FALL
ARRESTERS

RETRACTABLE
FALL ARRESTERS
AND BAGS

STRETCHERS

TRIPOD AND
CANTILEVER ARMS

HORIZONTAL
LIFELINES

VERTICAL
LIFELINES

RVL-100 A

VERTICAL LIFELINE WITH EXTENDED TOP BRACKET (SHOCK ABSORBER INTEGRATED)

- Made of galvanized steel.
- Extension bracket incorporates a shock absorber, further reducing impact force on the worker and the structure.
- Brackets are designed for ladder rungs but can be easily adapted to most structures.
- Tension indicator ensures proper tensioning of the system during installation.
- Sold as a complete system.

System Components

- RP-300I Extension bracket
- RP-300B Bottom anchorage bracket
- RA-50 Shock absorber
- RS-40 Turnbuckle & Indicator
- RC-30V Rope Guide
- RL-110 Wire rope

Note: System must be used only with F-5 Rope Grab.

Length : From 3 mt to desired length.

Standard: EN 353-1:2014



F-5

WIRE ROPE GRAB (FALL ARRESTER)

- Made of Stainless Steel.
- It is secured with a K-2/3ACP carabiner. Use of non-authorized carabiner can cause fatal accidents.
- The user is free to climb and descend with full use of the hands.

Standard: EN 353-1:2014



RVL-125

VERTICAL LIFELINE

- Made of galvanized steel.
- Brackets are designed for ladder rungs but can be easily adapted to most structures.
- Tension indicator ensures proper tensioning of the system during installation.
- Sold as a complete system.

System Components

- RP-300A Top anchorage bracket
- RP-300B Bottom anchorage bracket
- RS-40 Turnbuckle & Indicator
- RC-30V Rope Guide
- RL-125 Wire rope

Note: No shock absorber is installed on the system. Must only be used with F-5A Rope Grab.

Length : From 3 mt to desired length

Standard: EN 353-1:2014



F-5 A

WIRE ROPE GRAB WITH SHOCK ABSORBER

- Made of Stainless Steel.
- It is secured with a K-2/3ACP carabiner. Use of non authorized carabiner can cause fatal accidents.
- The user is free to climb and descend with full use of the hands.

Standard: EN 353-1:2014



RVL-125 A

VERTICAL LIFELINE WITH EXTENDED TOP BRACKET

- Made of galvanized steel.
- Brackets are designed for ladder rungs but can be easily adapted to most structures.
- Tension indicator ensures proper tensioning of the system during installation.
- Sold as a complete system.

System Components

- RP-300I Extension bracket
- RP-300B Bottom anchorage bracket
- RS-40 Turnbuckle & Indicator
- RC-30V Rope Guide
- RL-110 Wire rope

Note: System must be used only with F-5A Rope Grab.

Length : From 3 mt to desired length

Standard: EN 353-1:2014



F-5 A

WIRE ROPE GRAB WITH SHOCK ABSORBER

- Made of Stainless Steel.
- It is secured with a K-2/3ACP carabiner. Use of non authorized carabiner can cause fatal accidents.
- The user is free to climb and descend with full use of the hands.

Standard: EN 353-1:2014

HARNESSES

LANYARDS & SHOCK ABSORBERS

CARABINERS & ASCENDERS

HELMETS

MOBILE FALL ARRESTERS

RETRACTABLE FALL ARRESTERS AND BAGS

STRETCHERS

TRIPOD AND CANTILEVER ARMS

HORIZONTAL LIFELINES

VERTICAL LIFELINES



KAYA TRAINING KAYA CONSULTING

KAYA TRAINING and CONSULTING provides internal trainings primarily for Working at Height, Rescue Training for Specific Working Area, General OHS, OHS in the Electrical Works, PPE Inspection, Scaffold Inspection, Scaffolding Disassembly and Assembly. KAYA TRAINING and CONSULTING is also a partner of many internationally recognized organizations in Turkey such as IOSH, NSC, IRATA and apart from this company is able to provide their trainings with its own trainers.

WORK AT HEIGHT TRAINING (SPECIFIC BRANCH OF INDUSTRY)

- Telecommunications industry
- Wind turbine Industry work and rescue at height training
- Construction field
- Energy sector
- Work at height training at factory and production plants
- Rope access

RESCUE TRAINING FOR SPECIFIC WORKING AREAS

- Technical rescue at height
- Confined spaces
- Emergency event escape training
- Search and rescue

SCAFFOLDING TRAINING

- Scaffolding inspection training
- Scaffolding installation and dismantling training

OCCUPATIONAL HEALTH & SAFETY TRAINING

- General Occupational Health and Safety Training
- Occupational Health and Safety Training for Electric Plants
- Life Lines Installation Training
- PPE Inspection
- Fire Safety Training
- Basic First Aid Training
- Confined Space Safe Working
- Emergency Escape Systems

SAFE DRIVING TRAININGS

- Basic Training for Safe Driving
- Traffic Hazards Identification
- Off-Road 4x4

ADVICES FOR SECTOR BASED PPE AND TECHNICAL EQUIPMENT

- Energy & wind turbine training
- Construction
- Telecommunication
- Factory and production plants
- Rope access
- Roof and facade cleaning
- Closed areas
- Rescue and Evacuation

IOSH TRAININGS (INSTITUTION OF OCCUPATIONAL SAFETY AND HEALTH)

- IOSH Managing Safely
- IOSH Working Safely

NSC TRAININGS (NATIONAL SAFETY COUNCIL)

- Incident Investigation-Root Cause Analysis
- Safety Inspection
- Certificate in OSHA Compliance
- Ergonomics
- Fundamentals of Industrial Hygiene
- Principles of Occupational Safety and Health
- Safety Management Techniques
- Safety Management Leadership
- Safety Training Methods
- Supervisors Safety Development Program
- Team Safety

IRATA TRAININGS (INDUSTRIAL ROPE ACCESS TRADE ASSOCIATION)

- Rope Access Technician Level 1
- Rope Access Technician Level 2
- Rope Access Technician Level 3

CONTACT KAYA TRAINING

Tel : +90 262 677 19 15 pbx Fax: +90 262 677 19 18
E-mail: info@kayatraining.com.tr Web: www.kayatraining.com.tr



Work at height training (Sector based): Programme content and duration will be determined by representatives from the relevant sector and training experts taking into consideration the requirements of the particular sector. Duration of this course is minimum one day.

Working at height training: The purpose of this program is to provide basic information to employees working on heights. Duration of this course is three days. (advance & expert training is also provided)

Working at height training at wind turbines: The purpose of this program is to provide basic information to employees working at wind turbine industry. Duration of this course is three days.

Rescue training at wind turbines: Content of this course provides information on how to take action in the event of danger during working on wind turbines. Duration of this course is two days.

Rescue and Working at height training at wind turbines: The purpose of this program is to provide information to employees working at wind turbine industry. Duration of this course is three days.

Rescue training for specific working areas: The purpose of this course is to train participants to learn the rescue methods in the event of an incident. Duration of this course is two days.

Scaffolding Training: This training is recommended for anyone who install, demount or works on scaffolding. Duration of the course is two days.

Basic occupational health & safety training: Programme contents basic information for occupational health and Safety for variation of fields. Duration of the course is one day.

Occupational health & safety training for electric plants: Programme provides information on protecting employees against the potential risks of electric currents. Duration of the course is one day.

Occupational health & safety training in RF plants: Programme provides participants basic information and precautions against the effects of electromagnetic waves on those who work in related plants.

Duration of the course is one day.

Basic first aid training: Course teaches participants about the basic principles about the first aid. Duration of the course is two days.

General fire & Safety training: Course designed for all employees, to impart theoretical and practical knowledge about fire Safety for all necessary events. Duration of the course is one day.

Specific working at height training: Programme contents external rope Access training. Duration of the course is six days.

Special HSE training programs and training packages: This training is specifically designed to meet the needs and requirements of individual clients. Training includes a range of approaches and can be tailored for all levels of staff and Workgroups. Duration of course is depending on the chosen package.

Safe driving techniques training: Anyone who has driving license and drives in traffic can benefit from this training programme. Duration of this course is one day.

Collective protection systems training: Training for installation of collective protection systems. Duration of this course is one day.

Emergency escape systems training: Duration of this course is one day.

Working at height equipment maintenance and control training: Duration of this course is one day.

Note: Our consulting services help you prioritize issues and create comprehensive fall protection programs at our site or yours.

WORK SAFETY EQUIPMENT/PERSONAL PROTECTIVE EQUIPMENT

LIST OF EUROPEAN STANDARTS FOR FALL PROTECTION	
EN 363 Personal fall protection equipment	
EN 361 Personal protective equipment against falls from a height	
EN 358 Personal protective equipment for work positioning	
EN 813 Personal fall protection equipment - Sit harnesses	
EN 12277 Mountaineering equipment - Harnesses	
EN 355 Energy absorbers	
EN 354 Lanyards	
EN 362 Connectors	
EN 12278 Pulleys	
EN 795/B Anchor devices	
EN 567 Mountaineering equipment- Rope clamps	
EN 12841 Rope access systems	
EN 341 Descender devices for rescue	
EN 397 Industrial safety helmets	
EN 12492 Helmets for mountaineers	
EN 353-2 Guided type fall arresters including a flexible anchor line	
EN 360 Retractable type fall arresters	
EN 1496 Rescue equipment- Rescue lifting devices	
EN 566 Mountaineering equipment – Slings	
EN 12841 Rope access systems	
EN 892 Dynamic mountaineering ropes	
EN 1891 Low Stretch Kernmantel Ropes	
EN 564 Accessory cord	
EN 1263 Safety nets	
EN 353-1 Guided type fall arresters including a rigid anchor line (vertical lifeline)	
EN 795/C Anchor devices (permanent horizontal lifeline)	
EN 16415 Personal fall protection equipment - Anchor devices - Recommendations for anchor devices for use by more than one person simultaneously	
PROTECTIVE GLOVES	
EN 388 Protective gloves against mechanical risks	
EN 407 Protective gloves against thermal risks (heat and/or fire)	
EN 511 Protective gloves against cold	
EN 420 Protective gloves - General requirements and test methods	
EN 60903 Live working - Gloves of insulating material	
HEAD PROTECTION	
EN 397 Industrial safety helmets	
LIFTING EQUIPMENT	
EN 1492-1 Textile slings - Safety - Flat woven webbing slings for general purpose use (eye polyester sling)	
EN 1492-2 Textile slings - Safety (endless sling)	
CANADIAN STANDARDS ASSOCIATION (CSA)	
Z259.10 Full body harness	
AMERICAN NATIONAL STANDARDS INSTITUTE (ANSI)	
ANSI Z89.1 American National Standard for industrial head protection	
Class C Classic	
Class E Electric	
ANSI Z359.1 Safety requirements for personal fall arrest systems, sub systems and components	



LANYARDS AND SHOCK ABSORBERS

Albania

Poland

Sweden

Austria

Italy

Denmark

Germany

Holland

Norway

France

Spain

UK

Portugal

CARABINERS

HARNESSES

Canada

ROPES

STRETCHERS

USA

Colombia

ASCENDERS

HORIZONTAL LIFELINE

DEFENCE

Ecuador

Benin

Nigeria

Congo

Ghana

Greece

Guinea

Sudan

Liberia

Tanzania

Ivory Coast

LIFTING EQUIPMENT

ANCHORAGES

RE

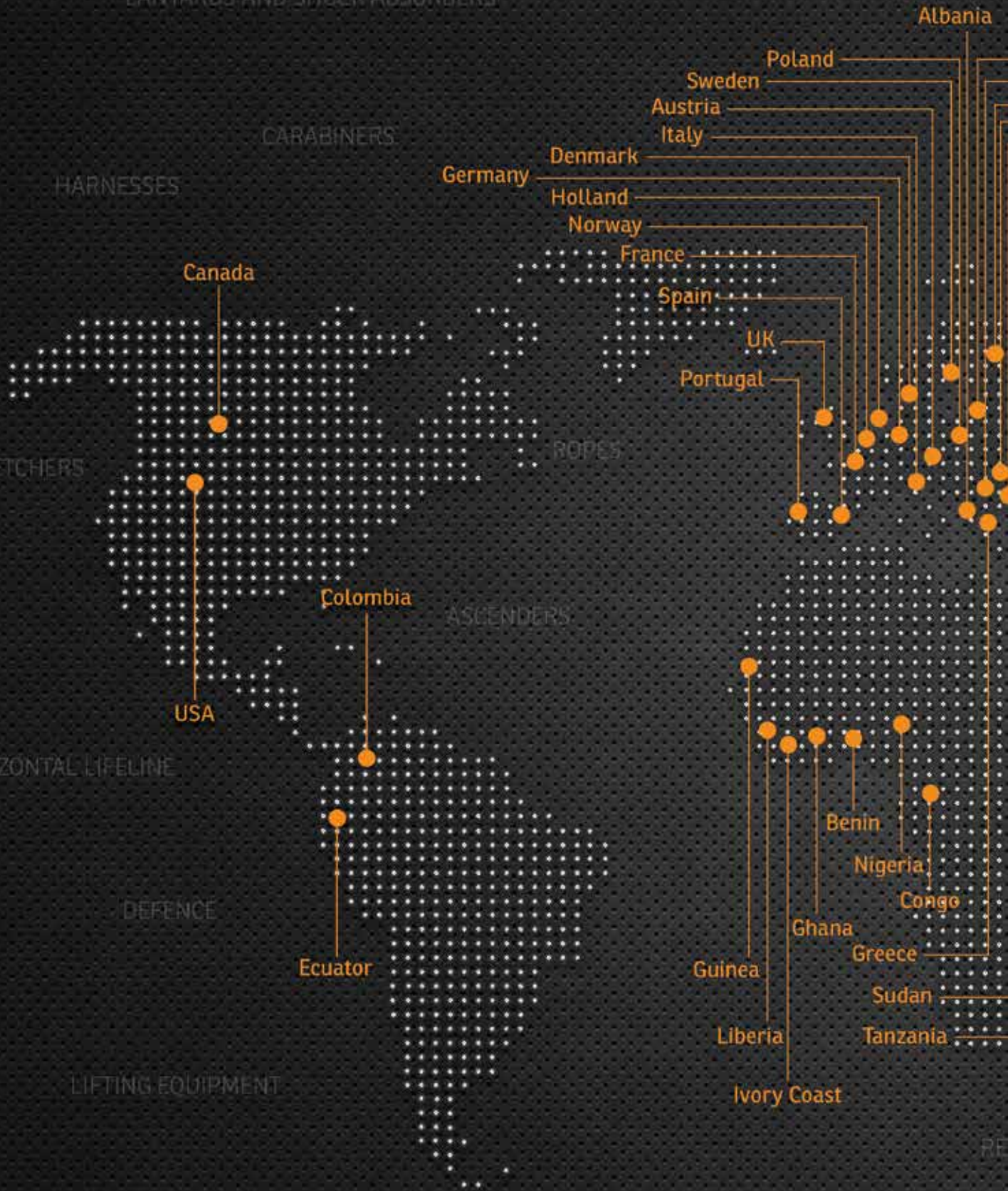

MOBILE FALL ARRESTERS

RESCUE DEVICES

TRIPOD AND CANTILEVER ARMS

HELMETS

SAFETY NETS

BAGS AND ACCESSORIES

VERTICAL LIFELINE

PULLEYS

DESCENDERS

TRACTABLE FALL ARRESTERS

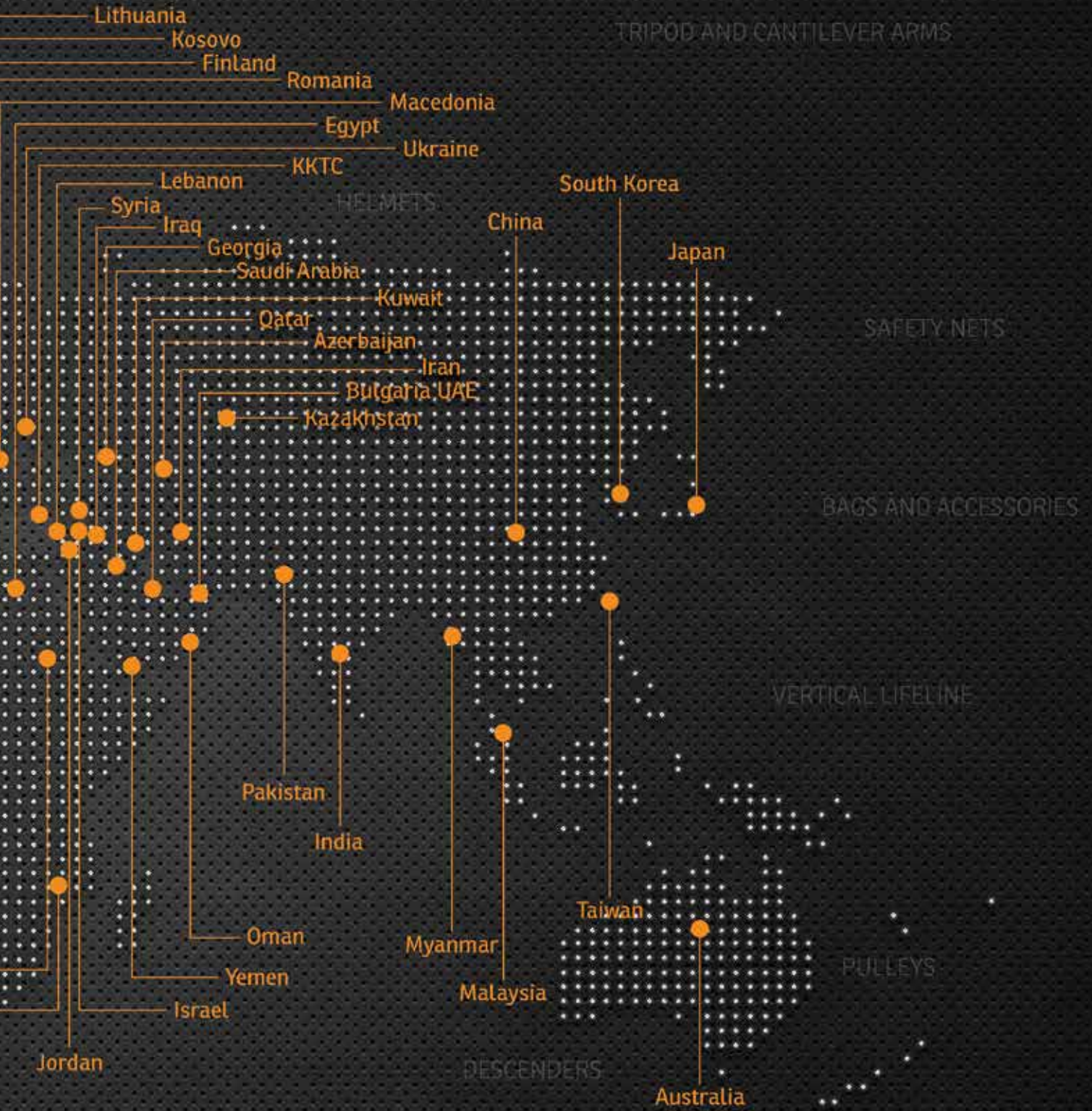

KAYA YAPI İÇ. MİM. TAS. İNŞ. DEN.
TAAH. SAN. VE TİC. A.Ş.

MANAGEMENT & PRODUCTION CENTER

GEBZE ORGANİZE SANAYİ BÖLGESİ
1000. SOKAK NO:1015
ÇAYIROVA, KOCAELİ, TURKEY
KAYAGRUBU.COM.TR

CENTRAL

T: +90 262 677 19 19 pbx
F: +90 262 677 19 10

KAYA SAFETY

GEBZE ORGANİZE SANAYİ BÖLGESİ
1000. SOKAK NO:1015
ÇAYIROVA, KOCAELİ, TURKEY
T: +90 262 677 19 00 pbx
F: +90 262 677 19 01
E-MAIL: SATIS@KAYASAFETY.COM

KAYASAFETY.COM



 /KAYASAFETY

 /COMPANY/KAYA-SAFETY

 /KAYA_SAFETY

 /KAYASAFETY

**HIGH
SAFETY
AT WORK**